

# ZEC 1,0/ 7-ST-3,5 C1 R1,7 - PCB connector



1893737

<https://www.phoenixcontact.com/us/products/1893737>

Please be informed that the data shown in this PDF document is generated from our online catalog. Please find the complete data in the user documentation. Our general terms of use for downloads are valid.

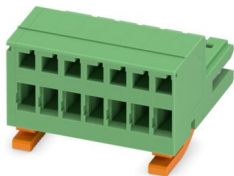

The figure shows a 10-position version of the product

PCB direct plug, nominal cross section: 1 mm<sup>2</sup>, color: green, nominal current: 8 A, rated voltage (III/2): 200 V, contact surface: Sn, contact connection type: Socket, number of potentials: 7, number of rows: 1, number of positions: 7, number of connections: 7, product range: ZEC 1,0/..-ST, pitch: 3.5 mm, connection method: Spring-cage connection, mounting: Direct plug-in method, conductor/PCB connection direction: 0 °, plug-in system: ZEC, locking: Snap-in locking, mounting method: Latching flange, type of packaging: packed in cardboard

## Your advantages

- Defined contact force ensures that contact remains stable over the long term
- Inexpensive direct plug-in connection with just one component
- Clamping space opened by means of fixed screwdriver enables convenient conductor connection
- Plug-in direction parallel to the PCB

## Commercial data

Item number	1893737
Packing unit	50 pc
Minimum order quantity	50 pc
Sales key	AA02
Product key	AABEAA
GTIN	4017918161286
Weight per piece (including packing)	8.564 g
Weight per piece (excluding packing)	8.134 g
Customs tariff number	85366930
Country of origin	GR

# ZEC 1,0/ 7-ST-3,5 C1 R1,7 - PCB connector



1893737

<https://www.phoenixcontact.com/us/products/1893737>

## Technical data

### Product properties

Product type	PCB direct plug
Product family	ZEC 1,0/...-ST
Product line	COMBICON Connectors S
Type	Direct plug connector
Number of positions	7
Pitch	3.5 mm
Number of connections	7
Number of rows	1
Number of potentials	7
Mounting type	without

### Electrical properties

#### Properties

Nominal current $I_N$	8 A
Nominal voltage $U_N$	200 V
Contact resistance	1.3 mΩ
Rated voltage (III/3)	160 V
Rated surge voltage (III/3)	2.5 kV
Rated voltage (III/2)	200 V
Rated surge voltage (III/2)	2.5 kV
Rated voltage (II/2)	320 V
Rated surge voltage (II/2)	2.5 kV

### Connection data

#### Connection technology

Type	Direct plug connector
Connector system	ZEC
Nominal cross section	1 mm <sup>2</sup>
Contact connection type	Socket

#### Interlock

Locking type	Snap-in locking
Mounting type	Latching flange

#### Conductor connection

Connection method	Spring-cage connection
Connection direction of the conductor to plug-in direction	0 °
Conductor cross-section rigid	0.2 mm <sup>2</sup> ... 1 mm <sup>2</sup>
Conductor cross-section flexible	0.2 mm <sup>2</sup> ... 1 mm <sup>2</sup>
Conductor cross-section AWG	24 ... 16

# ZEC 1,0/ 7-ST-3,5 C1 R1,7 - PCB connector



1893737

<https://www.phoenixcontact.com/us/products/1893737>

Conductor cross-section, flexible, with ferrule, without plastic sleeve	0.25 mm <sup>2</sup> ... 1 mm <sup>2</sup>
Conductor cross-section, flexible, with ferrule, with plastic sleeve	0.25 mm <sup>2</sup> ... 0.75 mm <sup>2</sup>
2 conductors with the same cross section, flexible, with TWIN ferrule with plastic sleeve	0.5 mm <sup>2</sup> ... 0.5 mm <sup>2</sup>
Stripping length	7 mm

## Specifications for ferrules without insulating collar

recommended crimping tool	1212034 CRIMPFOX 6
---------------------------	--------------------

## Specifications for ferrules with insulating collar

recommended crimping tool	1212034 CRIMPFOX 6
---------------------------	--------------------

## Mounting

Mounting type	Direct plug-in method
---------------	-----------------------

## Material specifications

### Material data - contact

Note	WEEE/RoHS-compliant, free of whiskers according to IEC 60068-2-82/JEDEC JESD 201
Contact material	Cu alloy
Surface characteristics	hot-dip tin-plated
Metal surface terminal point (top layer)	Tin (4 µm - 8 µm Sn)
Metal surface contact area (top layer)	Tin (4 µm - 8 µm Sn)

### Material data - housing

Color (Housing)	green (6021)
Insulating material	PA
Insulating material group	I
CTI according to IEC 60112	600
Flammability rating according to UL 94	V0
Glow wire flammability index GWFI according to EN 60695-2-12	850
Glow wire ignition temperature GWIT according to EN 60695-2-13	775
Temperature for the ball pressure test according to EN 60695-10-2	125 °C

## Notes

Notes on operation	In accordance with IEC 61984, COMBICON connectors have no switching power (COC). During designated use, they must not be plugged in or disconnected when carrying voltage or under load.
--------------------	--

## Dimensions

# ZEC 1,0/ 7-ST-3,5 C1 R1,7 - PCB connector



1893737

<https://www.phoenixcontact.com/us/products/1893737>

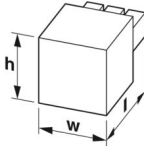
Dimensional drawing	
Pitch	3.5 mm
Width [w]	29.4 mm
Height [h]	17.5 mm
Length [l]	24.05 mm
Installed height	18 mm

## Mechanical tests

### Test for conductor damage and slackening

Specification	IEC 60999-1:1990-05
Result	Test passed

### Repeated connection and disconnection

Specification	IEC 60999-1:1990-05
Result	Test passed

### Pull-out test

Specification	IEC 60999-1:1990-05
Conductor cross-section/conductor type/tractive force setpoint/actual value	0.2 mm <sup>2</sup> / solid / > 10 N
	0.2 mm <sup>2</sup> / flexible / > 10 N
	1 mm <sup>2</sup> / solid / > 35 N
	1 mm <sup>2</sup> / flexible / > 35 N

### Insertion and withdrawal forces

Result	Test passed
No. of cycles	20
Insertion strength per pos. approx.	5 N
Withdraw strength per pos. approx.	3 N

### Resistance of inscriptions

Specification	IEC 60068-2-70:1995-12
Result	Test passed

### Visual inspection

Specification	IEC 60512-2:1985-00
Result	Test passed

### Dimension check

Specification	IEC 60512-2:1985-00
Result	Test passed

## Electrical tests

# ZEC 1,0/ 7-ST-3,5 C1 R1,7 - PCB connector



1893737

<https://www.phoenixcontact.com/us/products/1893737>

## Thermal test | Test group C

Specification	IEC 60512-5-1:2002-02
Tested number of positions	12

## Insulation resistance

Specification	IEC 60512-2:1985-00
Insulation resistance, neighboring positions	$10^{11} \Omega$

## Air clearances and creepage distances |

Specification	IEC 60664-1:2007-04
Insulating material group	I
Comparative tracking index (IEC 60112)	CTI 600
Rated insulation voltage (III/3)	160 V
Rated surge voltage (III/3)	2.5 kV
minimum clearance value - non-homogenous field (III/3)	1.5 mm
minimum creepage distance (III/3)	2 mm
Rated insulation voltage (III/2)	200 V
Rated surge voltage (III/2)	2.5 kV
minimum clearance value - non-homogenous field (III/2)	1.5 mm
minimum creepage distance (III/2)	1.5 mm
Rated insulation voltage (II/2)	320 V
Rated surge voltage (II/2)	2.5 kV
minimum clearance value - non-homogenous field (II/2)	1.5 mm
minimum creepage distance (II/2)	1.6 mm

## Environmental and real-life conditions

### Durability test

Specification	IEC 60512-5:1992-08
Contact resistance $R_1$	1.3 m $\Omega$
Contact resistance $R_2$	2 m $\Omega$
Insertion/withdrawal cycles	20

### Climatic test

Specification	ISO 6988:1985-02
Corrosive stress	0.2 dm <sup>3</sup> SO <sub>2</sub> on 300 dm <sup>3</sup> /40 °C/1 cycle
Thermal stress	100 °C/168 h
Power-frequency withstand voltage	1.39 kV

### Vibration test

Specification	IEC 60068-2-6:1995-03
Frequency	10 - 150 - 10 Hz
Sweep speed	1 octave/min
Amplitude	0.35 mm (10 Hz ... 60.1 Hz)
Acceleration	5g (60.1 Hz ... 150 Hz)
Test duration per axis	2.5 h

# ZEC 1,0/ 7-ST-3,5 C1 R1,7 - PCB connector



1893737

<https://www.phoenixcontact.com/us/products/1893737>

Test directions	X-, Y- and Z-axis
-----------------	-------------------

## Ambient conditions

Ambient temperature (storage/transport)	-40 °C ... 70 °C
Relative humidity (storage/transport)	30 % ... 70 %
Ambient temperature (assembly)	-5 °C ... 100 °C
Ambient temperature (operation)	-40 °C ... 100 °C (dependent on the derating curve)

## Ambient conditions

Ambient temperature (operation)	-40 °C ... 100 °C (dependent on the derating curve)
Ambient temperature (storage/transport)	-40 °C ... 70 °C
Relative humidity (storage/transport)	30 % ... 70 %
Ambient temperature (assembly)	-5 °C ... 100 °C

## Packaging specifications

Type of packaging	packed in cardboard
-------------------	---------------------

# ZEC 1,0/ 7-ST-3,5 C1 R1,7 - PCB connector

1893737

<https://www.phoenixcontact.com/us/products/1893737>

## Drawings

Dimensional drawing



Diagram



## Type: ZEC 1,0/...-ST-3,5

Derating curve, determined as per DIN EN 61984 (VDE 0627):2002-09

Representation based on DIN EN 60512-5-2:2003-01

Connected conductor cross-section = 1 mm<sup>2</sup>

Reduction factor = 0.8

Number of positions = see diagram

# ZEC 1,0/ 7-ST-3,5 C1 R1,7 - PCB connector



1893737

<https://www.phoenixcontact.com/us/products/1893737>

Drilling plan/solder pad geometry



Size of the PCB: 1.6 ± 0.2 mm

# ZEC 1,0/ 7-ST-3,5 C1 R1,7 - PCB connector



1893737

<https://www.phoenixcontact.com/us/products/1893737>

## Approvals

To download certificates, visit the product detail page: <https://www.phoenixcontact.com/us/products/1893737>

 <b>cULus Recognized</b> Approval ID: E60425-19941111				
	Nominal voltage $U_N$	Nominal current $I_N$	Cross section AWG	Cross section $\text{mm}^2$
B	150 V	8 A	26 - 16	-

 <b>VDE report with production monitoring</b> Approval ID: 40020343				
	Nominal voltage $U_N$	Nominal current $I_N$	Cross section AWG	Cross section $\text{mm}^2$
keine	160 V	8 A	-	0.2 - 1

# ZEC 1,0/ 7-ST-3,5 C1 R1,7 - PCB connector



1893737

<https://www.phoenixcontact.com/us/products/1893737>

## Classifications

### ECLASS

ECLASS-13.0	27460202
ECLASS-15.0	27460202

### ETIM

ETIM 10.0	EC002638
-----------	----------

### UNSPSC

UNSPSC 21.0	39121400
-------------	----------

# ZEC 1,0/ 7-ST-3,5 C1 R1,7 - PCB connector



1893737

<https://www.phoenixcontact.com/us/products/1893737>

## Environmental product compliance

### EU RoHS

Fulfills EU RoHS substance requirements	Yes, No exemptions
---	--------------------

### China RoHS

Environment friendly use period (EFUP)	EFUP-E
	No hazardous substances above the limits

### EU REACH SVHC

REACH candidate substance (CAS No.)	No substance above 0.1 wt%
-------------------------------------	----------------------------

Phoenix Contact 2026 © - all rights reserved  
<https://www.phoenixcontact.com>

Phoenix Contact USA  
586 Fulling Mill Road  
Middletown, PA 17057, United States  
(+717) 944-1300  
[info@phoenixcon.com](mailto:info@phoenixcon.com)