

# FKCVW 2,5/ 8-ST-5,08 - PCB connector

1873715

<https://www.phoenixcontact.com/us/products/1873715>

Please be informed that the data shown in this PDF document is generated from our online catalog. Please find the complete data in the user documentation. Our general terms of use for downloads are valid.

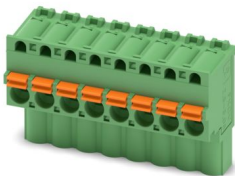

PCB connector, nominal cross section: 2.5 mm<sup>2</sup>, color: green, nominal current: 12 A, rated voltage (III/2): 320 V, contact surface: Sn, contact connection type: Socket, number of potentials: 8, number of rows: 1, number of positions: 8, number of connections: 8, product range: FKCVW 2,5/..-ST, pitch: 5.08 mm, connection method: Push-in spring connection, conductor/PCB connection direction: -90 °, locking clip: - Locking clip, plug-in system: COMBICON MSTB 2,5, locking: without, mounting method: without, type of packaging: packed in cardboard

## Your advantages

- Time saving push-in connection, tools not required
- Intuitive operation due to color-coded actuating push button
- Quick and convenient testing using integrated test option
- Can be combined with the MSTB 2,5 range

## Commercial data

Item number	1873715
Packing unit	50 pc
Minimum order quantity	50 pc
Sales key	AA03
Product key	AACFIC
GTIN	4017918143107
Weight per piece (including packing)	14.62 g
Weight per piece (excluding packing)	13.954 g
Customs tariff number	85366990
Country of origin	SK

# FKCVW 2,5/ 8-ST-5,08 - PCB connector



1873715

<https://www.phoenixcontact.com/us/products/1873715>

## Technical data

### Product properties

Product type	PCB connector
Product family	FKCVW 2,5/..-ST
Product line	COMBICON Connectors M
Type	Standard
Number of positions	8
Pitch	5.08 mm
Number of connections	8
Number of rows	1
Number of potentials	8
Mounting type	without

### Electrical properties

#### Properties

Nominal current $I_N$	12 A
Nominal voltage $U_N$	320 V
Contact resistance	1 m $\Omega$
Rated voltage (III/3)	250 V
Rated surge voltage (III/3)	4 kV
Rated voltage (III/2)	320 V
Rated surge voltage (III/2)	4 kV
Rated voltage (II/2)	630 V
Rated surge voltage (II/2)	4 kV

### Connection data

#### Connection technology

Type	Standard
Connector system	COMBICON MSTB 2,5
Nominal cross section	2.5 mm <sup>2</sup>
Contact connection type	Socket

#### Interlock

Locking type	without
Mounting type	without

#### Conductor connection

Connection method	Push-in spring connection
Conductor/PCB connection direction	-90 °
Conductor cross-section rigid	0.2 mm <sup>2</sup> ... 2.5 mm <sup>2</sup>
Conductor cross-section flexible	0.2 mm <sup>2</sup> ... 2.5 mm <sup>2</sup>
Conductor cross-section AWG	24 ... 12

# FKCVW 2,5/ 8-ST-5,08 - PCB connector



1873715

<https://www.phoenixcontact.com/us/products/1873715>

Conductor cross-section, flexible, with ferrule, without plastic sleeve	0.25 mm <sup>2</sup> ... 2.5 mm <sup>2</sup>
Conductor cross-section, flexible, with ferrule, with plastic sleeve	0.25 mm <sup>2</sup> ... 2.5 mm <sup>2</sup>
2 conductors with the same cross section, flexible, with TWIN ferrule with plastic sleeve	0.5 mm <sup>2</sup> ... 1.5 mm <sup>2</sup>
Cylindrical gauge a x b / diameter	2.8 mm x 2.0 mm / 2.3 mm
Stripping length	10 mm

## Specifications for ferrules without insulating collar

recommended crimping tool	1212034 CRIMPFOX 6
---------------------------	--------------------

## Specifications for ferrules with insulating collar

recommended crimping tool	1212034 CRIMPFOX 6
---------------------------	--------------------

## Material specifications

### Material data - contact

Note	WEEE/RoHS-compliant, free of whiskers according to IEC 60068-2-82/JEDEC JESD 201
Contact material	Cu alloy
Surface characteristics	hot-dip tin-plated
Metal surface terminal point (top layer)	Tin (4 µm - 8 µm Sn)
Metal surface contact area (top layer)	Tin (4 µm - 8 µm Sn)

### Material data - housing

Color (Housing)	green (6021)
Insulating material	PA
Insulating material group	I
CTI according to IEC 60112	600
Flammability rating according to UL 94	V0
Glow wire flammability index GWFI according to EN 60695-2-12	850
Glow wire ignition temperature GWIT according to EN 60695-2-13	775
Temperature for the ball pressure test according to EN 60695-10-2	125 °C

### Material data – actuating element

Color (Actuating element)	orange (2003)
Insulating material	PBT
Insulating material group	I
CTI according to IEC 60112	600
Flammability rating according to UL 94	V0

## Dimensions

# FKCVW 2,5/ 8-ST-5,08 - PCB connector



1873715

<https://www.phoenixcontact.com/us/products/1873715>

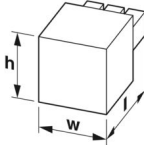
Dimensional drawing	
Pitch	5.08 mm
Width [w]	41.26 mm
Height [h]	19.2 mm
Length [l]	26.6 mm

## Notes

Notes on operation	In accordance with IEC 61984, COMBICON connectors have no switching power (COC). During designated use, they must not be plugged in or disconnected when carrying voltage or under load.
--------------------	--

## Mechanical tests

### Conductor connection

Specification	IEC 60999-1:1999-11
Result	Test passed

### Test for conductor damage and slackening

Specification	IEC 60999-1:1999-11
Result	Test passed

### Repeated connection and disconnection

Specification	IEC 60999-1:1999-11
Result	Test passed

### Pull-out test

Specification	IEC 60999-1:1999-11
Conductor cross-section/conductor type/tractive force setpoint/actual value	0.2 mm <sup>2</sup> / solid / > 10 N
	0.2 mm <sup>2</sup> / flexible / > 10 N
	2.5 mm <sup>2</sup> / solid / > 50 N
	2.5 mm <sup>2</sup> / flexible / > 50 N

### Insertion and withdrawal forces

Specification	IEC 60512-13-2:2006-02
Result	Test passed
No. of cycles	25
Insertion strength per pos. approx.	8 N
Withdraw strength per pos. approx.	6 N

### Resistance of inscriptions

Specification	IEC 60068-2-70:1995-12
Result	Test passed

# FKCVW 2,5/ 8-ST-5,08 - PCB connector



1873715

<https://www.phoenixcontact.com/us/products/1873715>

## Polarization and coding

Specification	IEC 60512-13-5:2006-02
Result	Test passed

## Visual inspection

Specification	IEC 60512-1-1:2002-02
Result	Test passed

## Dimension check

Specification	IEC 60512-1-2:2002-02
Result	Test passed

## Environmental and real-life conditions

### Durability test

Specification	IEC 60512-9-1:2010-03
Impulse withstand voltage at sea level	4.8 kV
Contact resistance $R_1$	1 m $\Omega$
Contact resistance $R_2$	1.1 m $\Omega$
Insertion/withdrawal cycles	25
Insulation resistance, neighboring positions	> 5 M $\Omega$

### Climatic test

Specification	ISO 6988:1985-02
Corrosive stress	0.2 dm <sup>3</sup> SO <sub>2</sub> on 300 dm <sup>3</sup> /40 °C/1 cycle
Thermal stress	100 °C/168 h
Power-frequency withstand voltage	2.21 kV

### Vibration test

Specification	IEC 60068-2-6:2007-12
Frequency	10 - 150 - 10 Hz
Sweep speed	1 octave/min
Amplitude	0.35 mm (10 Hz ... 60.1 Hz)
Acceleration	5g (60.1 Hz ... 150 Hz)
Test duration per axis	2.5 h
Test directions	X-, Y- and Z-axis

### Ambient conditions

Ambient temperature (storage/transport)	-40 °C ... 70 °C
Relative humidity (storage/transport)	30 % ... 70 %
Ambient temperature (assembly)	-5 °C ... 100 °C
Ambient temperature (operation)	-40 °C ... 100 °C (dependent on the derating curve)

## Electrical tests

### Thermal test | Test group C

Specification	IEC 60512-5-1:2002-02
---------------	-----------------------

# FKCVW 2,5/ 8-ST-5,08 - PCB connector



1873715

<https://www.phoenixcontact.com/us/products/1873715>

Tested number of positions	16
----------------------------	----

## Insulation resistance

Specification	IEC 60512-3-1:2002-02
Insulation resistance, neighboring positions	> 5 MΩ

## Air clearances and creepage distances |

Specification	IEC 60664-1:2007-04
Insulating material group	I
Comparative tracking index (IEC 60112)	CTI 600
Rated insulation voltage (III/3)	250 V
Rated surge voltage (III/3)	4 kV
minimum clearance value - non-homogenous field (III/3)	3 mm
minimum creepage distance (III/3)	3.2 mm
Rated insulation voltage (III/2)	320 V
Rated surge voltage (III/2)	4 kV
minimum clearance value - non-homogenous field (III/2)	3 mm
minimum creepage distance (III/2)	1.6 mm
Rated insulation voltage (II/2)	630 V
Rated surge voltage (II/2)	4 kV
minimum clearance value - non-homogenous field (II/2)	3 mm
minimum creepage distance (II/2)	3.2 mm

## Packaging specifications

Type of packaging	packed in cardboard
-------------------	---------------------

1873715

<https://www.phoenixcontact.com/us/products/1873715>

## Drawings



Type: FKCV(W/R) 2,5/...-ST-5,08 with MSTB 2,5/...-G-5,08



Type: FKCV(R/W) 2,5/...-ST-5,08 with MDSTB 2,5/...-G-5,08

1873715

<https://www.phoenixcontact.com/us/products/1873715>



Type: FKCV(W/R) 2,5/...-ST-5,08 with MDSTBA 2,5/...-G-5,08



Type: FKCV(R/W) 2,5/...-ST-5,08 with MDSTBV 2,5/...-G-5,08

1873715

<https://www.phoenixcontact.com/us/products/1873715>



Type: FKCV(W/R) 2,5/...-ST-5,08 with CC 2,5/...-G-5,08 P...THR



Type: FKCV(W/R) 2,5/...-ST-5,08 with SMSTB 2,5/...-G-5,08

# FKCVW 2,5/ 8-ST-5,08 - PCB connector



1873715

<https://www.phoenixcontact.com/us/products/1873715>



Type: FKCV(W/R) 2,5/...-ST-5,08 with SMSTBA 2,5/...-G-5,08



Type: FKCV(W/R) 2,5/...-ST-5,08 with MDSTBW 2,5/...-G-5,08

# FKCVW 2,5/ 8-ST-5,08 - PCB connector



1873715

<https://www.phoenixcontact.com/us/products/1873715>



Type: FKCVW 2,5/...-ST-5,08 with MSTBA 2,5/...-G-5,08



Type: FKCVW 2,5/...-ST-5,08 with MSTBV 2,5/...-G-5,08

1873715

<https://www.phoenixcontact.com/us/products/1873715>



Type: FKCVW 2,5/...-ST-5,08 with MSTBW 2,5/...-G-5,08

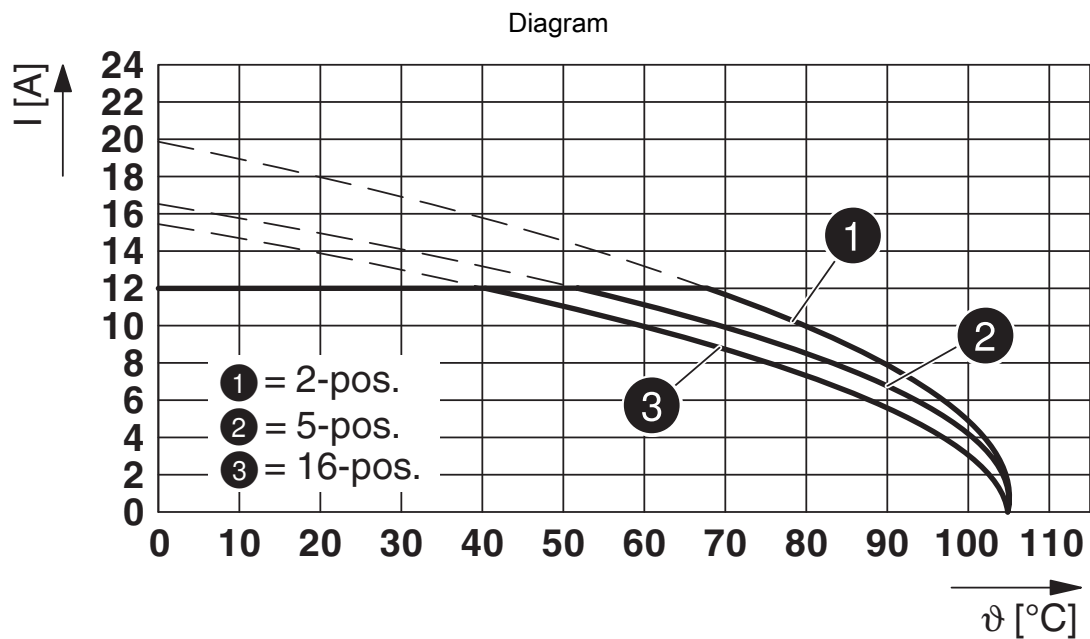

Type: FKCVW 2,5/...-ST-5,08 with MSTBVA 2,5/...-G-5,08

# FKCVW 2,5/ 8-ST-5,08 - PCB connector



1873715

<https://www.phoenixcontact.com/us/products/1873715>

Diagram



Type: FKCVW 2,5/...-ST-5,08 with CCV 2,5/...-G-5,08 P26THR

Diagram



Type: FKCVW 2,5/...-ST-5,08 with MDSTBVA 2,5/...-G-5,08



Type: FKCVW 2,5/...-ST-5,08 with MDSTBV 2,5/...-G1-5,08



Type: FKCVW 2,5/...-ST-5,08 with MDSTB 2,5/...-G1-5,08

# FKCVW 2,5/ 8-ST-5,08 - PCB connector



1873715

<https://www.phoenixcontact.com/us/products/1873715>

## Approvals

To download certificates, visit the product detail page: <https://www.phoenixcontact.com/us/products/1873715>

 <b>cULus Recognized</b> Approval ID: E60425-19931011				
	Nominal voltage $U_N$	Nominal current $I_N$	Cross section AWG	Cross section $\text{mm}^2$
B	300 V	10 A	26 - 12	-
D	300 V	10 A	26 - 12	-

 <b>VDE approval of drawings</b> Approval ID: 40050694				
	Nominal voltage $U_N$	Nominal current $I_N$	Cross section AWG	Cross section $\text{mm}^2$
keine	250 V	12 A	-	0.2 - 2.5

# FKCVW 2,5/ 8-ST-5,08 - PCB connector



1873715

<https://www.phoenixcontact.com/us/products/1873715>

## Classifications

### ECLASS

ECLASS-13.0	27460202
ECLASS-15.0	27460202

### ETIM

ETIM 10.0	EC002638
-----------	----------

### UNSPSC

UNSPSC 21.0	39121400
-------------	----------

# FKCVW 2,5/ 8-ST-5,08 - PCB connector



1873715

<https://www.phoenixcontact.com/us/products/1873715>

## Environmental product compliance

### EU RoHS

Fulfills EU RoHS substance requirements	Yes, No exemptions
---	--------------------

### China RoHS

Environment friendly use period (EFUP)	EFUP-E
	No hazardous substances above the limits

### EU REACH SVHC

REACH candidate substance (CAS No.)	No substance above 0.1 wt%
-------------------------------------	----------------------------

Phoenix Contact 2026 © - all rights reserved  
<https://www.phoenixcontact.com>

Phoenix Contact USA  
586 Fulling Mill Road  
Middletown, PA 17057, United States  
(+717) 944-1300  
[info@phoenixcon.com](mailto:info@phoenixcon.com)