

SDC 2,5/ 7-PV-5,0-ZB - Direct connector



1864082

<https://www.phoenixcontact.com/us/products/1864082>

Please be informed that the data shown in this PDF document is generated from our online catalog. Please find the complete data in the user documentation. Our general terms of use for downloads are valid.

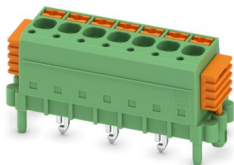

PCB direct plug, nominal cross section: 2.5 mm², color: green, nominal current: 12 A, rated voltage (III/2): 320 V, contact surface: Sn, number of potentials: 7, number of rows: 1, number of positions: 7, number of connections: 7, product range: SDC 2,5/..-PV, pitch: 5 mm, connection method: Push-in spring connection, mounting: SKEDD - Direct plug-in technology, conductor/PCB connection direction: 90 °, pin layout: Zigzag pinning W, solder pin [P]: 5 mm, plug-in system: SKEDD, locking: Snap-in locking, mounting method: Latching flange, type of packaging: packed in cardboard

Your advantages

- SKEDD direct plug-in technology enables flexible positioning on the PCB
- Reduced component and process costs: simple insertion by hand and vibration-resistant connection
- Wide range of applications, thanks to suitability for PCBs with chemically tin-plated or Hot Air Leveling (HAL) surface
- Time saving push-in connection, tools not required
- Intuitive operation due to color-coded actuating push button
- Quick and convenient testing using integrated test option

Commercial data

Item number	1864082
Packing unit	50 pc
Minimum order quantity	50 pc
Sales key	AA03
Product key	AACDBA
GTIN	4055626210384
Weight per piece (including packing)	9.116 g
Weight per piece (excluding packing)	8.412 g
Customs tariff number	85366990
Country of origin	SK

SDC 2,5/ 7-PV-5,0-ZB - Direct connector



1864082

<https://www.phoenixcontact.com/us/products/1864082>

Technical data

Product properties

Product type	PCB direct plug
Product family	SDC 2,5/...-PV
Product line	COMBICON Connectors M
Number of positions	7
Pitch	5 mm
Number of connections	7
Number of rows	1
Number of potentials	7
Pin layout	Zigzag pinning W

Electrical properties

Properties

Nominal current I_N	12 A
Nominal voltage U_N	320 V
Contact resistance	1.1 m Ω
Rated voltage (III/3)	200 V
Rated surge voltage (III/3)	4 kV
Rated voltage (III/2)	320 V
Rated surge voltage (III/2)	4 kV
Rated voltage (II/2)	320 V
Rated surge voltage (II/2)	4 kV

Connection data

Connection technology

Connector system	SKEDD
Nominal cross section	2.5 mm ²

Interlock

Locking type	Snap-in locking
Mounting type	Latching flange

Conductor connection

Connection method	Push-in spring connection
Connection direction of the conductor to plug-in direction	0 °
Conductor cross-section rigid	0.2 mm ² ... 2.5 mm ²
Conductor cross-section flexible	0.2 mm ² ... 2.5 mm ²
Conductor cross-section AWG	24 ... 12
Conductor cross-section, flexible, with ferrule, without plastic sleeve	0.25 mm ² ... 2.5 mm ²
Conductor cross-section, flexible, with ferrule, with plastic sleeve	0.25 mm ² ... 2.5 mm ²
Cylindrical gauge a x b / diameter	2.4 mm x 1.5 mm / 2.4 mm

SDC 2,5/ 7-PV-5,0-ZB - Direct connector



1864082

<https://www.phoenixcontact.com/us/products/1864082>

Stripping length	10 mm
------------------	-------

Conductor connection

Connection method	Push-in spring connection
Stripping length	10 mm

Specifications for ferrules without insulating collar

recommended crimping tool	1212045 CRIMPFOX 10S
ferrules without insulating collar, according to DIN 46228-1	Cross section: 0.25 mm ² ; Length: 7 mm
	Cross section: 0.34 mm ² ; Length: 7 mm
	Cross section: 0.5 mm ² ; Length: 8 mm ... 10 mm
	Cross section: 0.75 mm ² ; Length: 10 mm
	Cross section: 1 mm ² ; Length: 10 mm
	Cross section: 2.5 mm ² ; Length: 10 mm

Specifications for ferrules with insulating collar

recommended crimping tool	1212045 CRIMPFOX 10S
ferrules with insulating collar, according to DIN 46228-4	Cross section: 0.25 mm ² ; Length: 8 mm
	Cross section: 0.34 mm ² ; Length: 8 mm ... 10 mm
	Cross section: 0.5 mm ² ; Length: 8 mm ... 10 mm
	Cross section: 0.75 mm ² ; Length: 8 mm ... 10 mm
	Cross section: 1 mm ² ; Length: 8 mm ... 10 mm
	Cross section: 1.5 mm ² ; Length: 8 mm ... 10 mm
	Cross section: 2.5 mm ² ; Length: 10 mm

Mounting

Mounting type	SKEDD - Direct plug-in technology
Pin layout	Zigzag pinning W

Material specifications

Material data - contact

Note	WEEE/RoHS-compliant, free of whiskers according to IEC 60068-2-82/JEDEC JESD 201
Contact material	Cu alloy
Surface characteristics	Tin-plated
Metal surface terminal point (top layer)	Tin (4 µm - 8 µm Sn)
Metal surface terminal point (middle layer)	Nickel (1.5 µm - 4 µm Ni)
Metal surface contact area (top layer)	Tin (4 µm - 8 µm Sn)
Metal surface contact area (middle layer)	Nickel (1.5 µm - 4 µm Ni)

Material data - housing

Color (Housing)	green (6021)
Insulating material	PA
Insulating material group	I
CTI according to IEC 60112	600
Flammability rating according to UL 94	V0

SDC 2,5/ 7-PV-5,0-ZB - Direct connector



1864082

<https://www.phoenixcontact.com/us/products/1864082>

Glow wire flammability index GWFI according to EN 60695-2-12	850
Glow wire ignition temperature GWIT according to EN 60695-2-13	775
Temperature for the ball pressure test according to EN 60695-10-2	125 °C

Material data – actuating element

Insulating material	PBT
Insulating material group	IIIa
CTI according to IEC 60112	275
Flammability rating according to UL 94	V0

Notes

Notes on operation	In accordance with IEC 61984, COMBICON connectors have no switching power (COC). During designated use, they must not be plugged in or disconnected when carrying voltage or under load.
--------------------	--

Dimensions

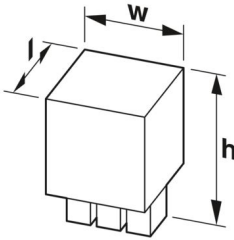
Dimensional drawing	
Pitch	5 mm
Width [w]	43.18 mm
Height [h]	21.2 mm
Length [l]	15.3 mm
Installed height	16.2 mm
Solder pin length [P]	5 mm

PCB design

Pin spacing	10.00 mm
Hole diameter	2.4 mm

Mechanical tests

Conductor connection

Specification	IEC 60999-1:1999-11
Result	Test passed

Test for conductor damage and slackening

Specification	IEC 60999-1:1999-11
Result	Test passed

Repeated connection and disconnection

SDC 2,5/ 7-PV-5,0-ZB - Direct connector



1864082

<https://www.phoenixcontact.com/us/products/1864082>

Specification	IEC 60999-1:1999-11
Result	Test passed

Pull-out test

Specification	IEC 60999-1:1999-11
Conductor cross-section/conductor type/tractive force setpoint/actual value	0.2 mm ² / solid / > 10 N
	0.2 mm ² / flexible / > 10 N
	2.5 mm ² / solid / > 50 N
	2.5 mm ² / flexible / > 50 N

Insertion and withdrawal forces

Result	Test passed
No. of cycles	25
Insertion strength per pos. approx.	8 N
Withdraw strength per pos. approx.	6 N

Contact holder in insert

Specification	IEC 60512-15-1:2008-05
Contact holder in insert Requirements >20 N	Test passed

Resistance of inscriptions

Specification	IEC 60068-2-70:1995-12
Result	Test passed

Polarization and coding

Specification	IEC 60512-13-5:2006-02
Result	Test passed

Visual inspection

Specification	IEC 60512-1-1:2002-02
Result	Test passed

Dimension check

Specification	IEC 60512-1-2:2002-02
Result	Test passed

Electrical tests

Thermal test | Test group C

Specification	IEC 60512-5-1:2002-02
Tested number of positions	16

Insulation resistance

Specification	IEC 60512-3-1:2002-02
Insulation resistance, neighboring positions	> 5 MΩ

Temperature cycles

Specification	IEC 60999-1:1999-11
---------------	---------------------

SDC 2,5/ 7-PV-5,0-ZB - Direct connector



1864082

<https://www.phoenixcontact.com/us/products/1864082>

Result	Test passed
Air clearances and creepage distances	
Specification	IEC 60664-1:2007-04
Insulating material group	I
Comparative tracking index (IEC 60112)	CTI 275
Rated insulation voltage (III/3)	200 V
Rated surge voltage (III/3)	4 kV
minimum clearance value - non-homogenous field (III/3)	3 mm
minimum creepage distance (III/3)	3.2 mm
Rated insulation voltage (III/2)	320 V
Rated surge voltage (III/2)	4 kV
minimum clearance value - non-homogenous field (III/2)	3 mm
minimum creepage distance (III/2)	3.2 mm
Rated insulation voltage (II/2)	320 V
Rated surge voltage (II/2)	4 kV
minimum clearance value - non-homogenous field (II/2)	3 mm
minimum creepage distance (II/2)	3.2 mm

Environmental and real-life conditions

Durability test

Specification	IEC 60512-9-1:2010-03
Impulse withstand voltage at sea level	4.8 kV
Contact resistance R_1	1.1 m Ω
Contact resistance R_2	1.1 m Ω
Insertion/withdrawal cycles	25
Insulation resistance, neighboring positions	> 5 M Ω

Climatic test

Specification	ISO 6988:1985-02
Corrosive stress	0.2 dm ³ SO ₂ on 300 dm ³ /40 °C/1 cycle
Thermal stress	100 °C/168 h
Power-frequency withstand voltage	2.21 kV

Vibration test

Specification	IEC 60068-2-6:2007-12
Frequency	10 - 150 - 10 Hz
Sweep speed	1 octave/min
Amplitude	0.35 mm (10 Hz ... 60.1 Hz)
Acceleration	5g (60.1 Hz ... 150 Hz)
Test duration per axis	2.5 h
Test directions	X-, Y- and Z-axis

Shocks

Specification	IEC 60068-2-27:2008-02
---------------	------------------------

SDC 2,5/ 7-PV-5,0-ZB - Direct connector



1864082

<https://www.phoenixcontact.com/us/products/1864082>

Pulse shape	Semi-sinusoidal
Acceleration	30g
Shock duration	18 ms
Test directions	X-, Y- and Z-axis (pos. and neg.)

Ambient conditions

Ambient temperature (storage/transport)	-40 °C ... 70 °C
Relative humidity (storage/transport)	30 % ... 70 %
Ambient temperature (assembly)	-5 °C ... 100 °C
Ambient temperature (operation)	-40 °C ... 100 °C (dependent on the derating curve)

Ambient conditions

Ambient temperature (operation)	-40 °C ... 100 °C (dependent on the derating curve)
Ambient temperature (storage/transport)	-40 °C ... 70 °C
Relative humidity (storage/transport)	30 % ... 70 %
Ambient temperature (assembly)	-5 °C ... 100 °C

Packaging specifications

Type of packaging	packed in cardboard
-------------------	---------------------

SDC 2,5/ 7-PV-5,0-ZB - Direct connector



1864082

<https://www.phoenixcontact.com/us/products/1864082>

Drawings

Dimensional drawing



Diagram



Type: SDC 2,5/...-PV-5,0-ZB

SDC 2,5/ 7-PV-5,0-ZB - Direct connector



1864082

<https://www.phoenixcontact.com/us/products/1864082>

Approvals

To download certificates, visit the product detail page: <https://www.phoenixcontact.com/us/products/1864082>

 cULus Recognized Approval ID: E60425-20160718				
	Nominal voltage U_N	Nominal current I_N	Cross section AWG	Cross section mm^2
B	300 V	12 A	24 - 12	-
D	300 V	10 A	24 - 12	-

 VDE Zeichengenehmigung Approval ID: 40044617				
	Nominal voltage U_N	Nominal current I_N	Cross section AWG	Cross section mm^2
keine	320 V	12 A	-	0.2 - 2.5

 UL Recognized Approval ID: E60425-20160718				
	Nominal voltage U_N	Nominal current I_N	Cross section AWG	Cross section mm^2
F	250 V	12 A	24 - 12	-

SDC 2,5/ 7-PV-5,0-ZB - Direct connector



1864082

<https://www.phoenixcontact.com/us/products/1864082>

Classifications

ECLASS

ECLASS-13.0	27460202
ECLASS-15.0	27460202

ETIM

ETIM 10.0	EC002638
-----------	----------

UNSPSC

UNSPSC 21.0	39121400
-------------	----------

SDC 2,5/ 7-PV-5,0-ZB - Direct connector



1864082

<https://www.phoenixcontact.com/us/products/1864082>

Environmental product compliance

EU RoHS

Fulfills EU RoHS substance requirements	Yes, No exemptions
---	--------------------

China RoHS

Environment friendly use period (EFUP)	EFUP-E
	No hazardous substances above the limits

EU REACH SVHC

REACH candidate substance (CAS No.)	No substance above 0.1 wt%
-------------------------------------	----------------------------

EF3.1 Climate Change

CO2e kg	0.211 kg CO2e
---------	---------------

Phoenix Contact 2026 © - all rights reserved
<https://www.phoenixcontact.com>

Phoenix Contact USA
586 Fulling Mill Road
Middletown, PA 17057, United States
(+717) 944-1300
info@phoenixcon.com