

IC-DFR 12 - Accessories

1852121

<https://www.phoenixcontact.com/us/products/1852121>

Please be informed that the data shown in this PDF document is generated from our online catalog. Please find the complete data in the user documentation. Our general terms of use for downloads are valid.



Panel-mount frame, nominal cross section: 2.5 mm², color: green, number of potentials: 12, number of rows: 1, number of positions: 12, number of connections: 12, product range: IC-DFR, pitch: 5.08 mm, type of packaging: packed in cardboard, This assembly frame can only be used in combination with IC 2,5/...-STGF-5,08

Your advantages

- Feed-through assembly frame for inverted COMBICON connector IC 2,5/-STGF-5,08
- Cable connection on the inside of the device enables flexible positioning of the panel feed-through
- Mounting flanges reduce the mechanical strain on the soldering spots
- Can be combined with the MSTB 2,5 range

Commercial data

Item number	1852121
Packing unit	50 pc
Minimum order quantity	50 pc
Sales key	AA08
Product key	AAHZBE
GTIN	4017918109004
Weight per piece (including packing)	3.24 g
Weight per piece (excluding packing)	2.9 g
Customs tariff number	39269097
Country of origin	PL

IC-DFR 12 - Accessories



1852121

<https://www.phoenixcontact.com/us/products/1852121>

Environmental and real-life conditions

Ambient conditions

Relative humidity (storage/transport)	30 % ... 70 %
---------------------------------------	---------------

Packaging specifications

Type of packaging	packed in cardboard
-------------------	---------------------

1852121

<https://www.phoenixcontact.com/us/products/1852121>

Drawings

Drilling plan/solder pad geometry

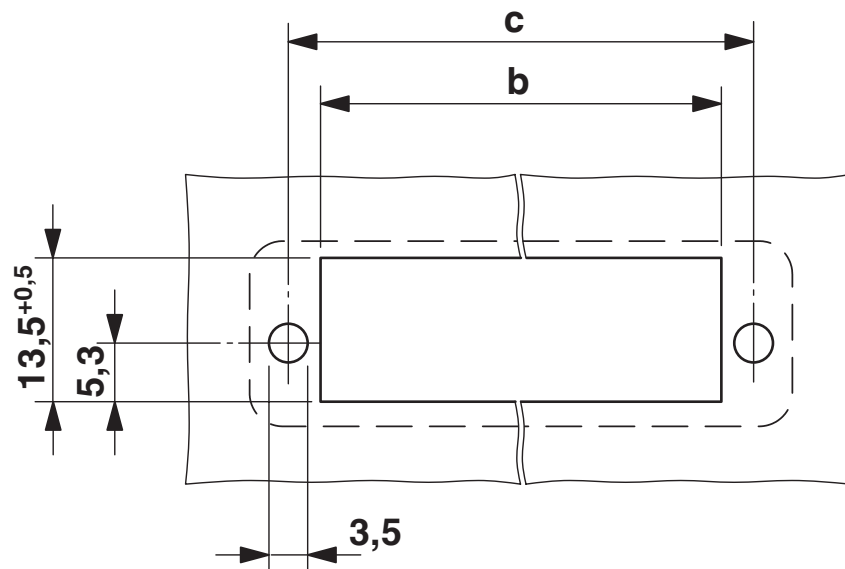

Dimension b: $10.84 \text{ mm} + (\text{no. of pos.} \times 5.08 \text{ mm})$

Dimension c: $\text{Dim. b} + 5.83 \text{ mm}$

IC-DFR 12 - Accessories



1852121

<https://www.phoenixcontact.com/us/products/1852121>

Classifications

ECLASS

ECLASS-15.0	27460405
ECLASS-13.0	27460405

ETIM

ETIM 10.0	EC002943
-----------	----------

UNSPSC

UNSPSC 21.0	39121400
-------------	----------

IC-DFR 12 - Accessories



1852121

<https://www.phoenixcontact.com/us/products/1852121>

Environmental product compliance

EU RoHS

Fulfills EU RoHS substance requirements	Yes, No exemptions
---	--------------------

China RoHS

Environment friendly use period (EFUP)	EFUP-E
	No hazardous substances above the limits

EU REACH SVHC

REACH candidate substance (CAS No.)	No substance above 0.1 wt%
-------------------------------------	----------------------------

EF3.1 Climate Change

CO2e kg	0.021 kg CO2e
---------	---------------

Phoenix Contact 2026 © - all rights reserved
<https://www.phoenixcontact.com>

Phoenix Contact USA
586 Fulling Mill Road
Middletown, PA 17057, United States
(+717) 944-1300
info@phoenixcon.com