

# FRONT-MC 1,5/18-ST-3,81 - PCB connector



1850822

<https://www.phoenixcontact.com/us/products/1850822>

Please be informed that the data shown in this PDF document is generated from our online catalog. Please find the complete data in the user documentation. Our general terms of use for downloads are valid.



PCB connector, nominal cross section: 1.5 mm<sup>2</sup>, color: green, nominal current: 8 A, rated voltage (III/2): 160 V, contact surface: Sn, contact connection type: Socket, number of potentials: 18, number of rows: 1, number of positions: 18, number of connections: 18, product range: FRONT-MC 1,5/..-ST, pitch: 3.81 mm, connection method: Front screw connection, screw head form: L Slotted, conductor/PCB connection direction: 0 °, plug-in system: COMBICON MC 1,5, locking: without, mounting method: without, type of packaging: packed in cardboard

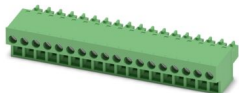

## Your advantages

- Well-known connection principle allows worldwide use
- Low temperature rise, thanks to maximum contact force
- Optimized for tight installation situations: operation and conductor connection from one direction

## Commercial data

|                                      |               |
|--------------------------------------|---------------|
| Item number                          | 1850822       |
| Packing unit                         | 50 pc         |
| Minimum order quantity               | 50 pc         |
| Sales key                            | AA02          |
| Product key                          | AABALA        |
| GTIN                                 | 4017918109875 |
| Weight per piece (including packing) | 23.981 g      |
| Weight per piece (excluding packing) | 23.42 g       |
| Customs tariff number                | 85366990      |
| Country of origin                    | DE            |

# FRONT-MC 1,5/18-ST-3,81 - PCB connector



1850822

<https://www.phoenixcontact.com/us/products/1850822>

## Technical data

### Product properties

|                       |                       |
|-----------------------|-----------------------|
| Product type          | PCB connector         |
| Product family        | FRONT-MC 1,5/..-ST    |
| Product line          | COMBICON Connectors S |
| Type                  | Standard              |
| Number of positions   | 18                    |
| Pitch                 | 3.81 mm               |
| Number of connections | 18                    |
| Number of rows        | 1                     |
| Number of potentials  | 18                    |
| Mounting type         | without               |

### Electrical properties

#### Properties

|                             |                |
|-----------------------------|----------------|
| Nominal current $I_N$       | 8 A            |
| Nominal voltage $U_N$       | 160 V          |
| Contact resistance          | 1.6 m $\Omega$ |
| Rated voltage (III/3)       | 160 V          |
| Rated surge voltage (III/3) | 2.5 kV         |
| Rated voltage (III/2)       | 160 V          |
| Rated surge voltage (III/2) | 2.5 kV         |
| Rated voltage (II/2)        | 320 V          |
| Rated surge voltage (II/2)  | 2.5 kV         |

### Connection data

#### Connection technology

|                         |                     |
|-------------------------|---------------------|
| Type                    | Standard            |
| Connector system        | COMBICON MC 1,5     |
| Nominal cross section   | 1.5 mm <sup>2</sup> |
| Contact connection type | Socket              |

#### Interlock

|               |         |
|---------------|---------|
| Locking type  | without |
| Mounting type | without |

#### Conductor connection

|                                    |  |
|------------------------------------|--|
| Connection method                  | Front screw connection                       |
| Conductor/PCB connection direction | 0 °  |
| Conductor cross-section rigid      | 0.14 mm <sup>2</sup> ... 1.5 mm <sup>2</sup> |
| Conductor cross-section flexible   | 0.14 mm <sup>2</sup> ... 1.5 mm <sup>2</sup> |
| Conductor cross-section AWG        | 28 ... 16                                    |

# FRONT-MC 1,5/18-ST-3,81 - PCB connector



1850822

<https://www.phoenixcontact.com/us/products/1850822>

|   |   |
|---|---|
| Conductor cross-section, flexible, with ferrule, without plastic sleeve                   | 0.25 mm <sup>2</sup> ... 1.5 mm <sup>2</sup>  |
| Conductor cross-section, flexible, with ferrule, with plastic sleeve                      | 0.25 mm <sup>2</sup> ... 0.5 mm <sup>2</sup>  |
| 2 conductors with same cross section, rigid   | 0.14 mm <sup>2</sup> ... 0.5 mm <sup>2</sup>  |
| 2 conductors with same cross section, flexible  | 0.14 mm <sup>2</sup> ... 0.75 mm <sup>2</sup> |
| 2 conductors with same cross section, flexible, with ferrule without plastic sleeve       | 0.25 mm <sup>2</sup> ... 0.34 mm <sup>2</sup> |
| 2 conductors with the same cross section, flexible, with TWIN ferrule with plastic sleeve | 0.5 mm <sup>2</sup> ... 0.5 mm <sup>2</sup>   |
| Cylindrical gauge a x b / diameter  | 2.4 mm x 1.5 mm / 1.6 mm                      |
| Stripping length  | 9 mm  |
| Drive form screw head   | Slotted (L)                                   |
| Tightening torque   | 0.22 Nm ... 0.25 Nm                           |

## Specifications for ferrules without insulating collar

|  |   |
|--|---|
| ferrules without insulating collar, according to DIN 46228-1 | Cross section: 0.25 mm <sup>2</sup> ; Length: 7 mm ... 9 mm |
|  | Cross section: 0.34 mm <sup>2</sup> ; Length: 7 mm ... 9 mm |
|  | Cross section: 0.5 mm <sup>2</sup> ; Length: 8 mm ... 9 mm  |
|  | Cross section: 0.75 mm <sup>2</sup> ; Length: 8 mm ... 9 mm |
|  | Cross section: 1 mm <sup>2</sup> ; Length: 8 mm ... 9 mm    |
|  | Cross section: 1.5 mm <sup>2</sup> ; Length: 9 mm           |

## Specifications for ferrules with insulating collar

|   |   |
|---|---|
| ferrules with insulating collar, according to DIN 46228-4 | Cross section: 0.25 mm <sup>2</sup> ; Length: 8 mm ... 9 mm |
|   | Cross section: 0.34 mm <sup>2</sup> ; Length: 8 mm ... 9 mm |
|   | Cross section: 0.5 mm <sup>2</sup> ; Length: 8 mm ... 9 mm  |

## Material specifications

### Material data - contact

|  |  |
|--|--|
| Note                                     | WEEE/RoHS-compliant, free of whiskers according to IEC 60068-2-82/JEDEC JESD 201 |
| Contact material                         | Cu alloy   |
| Surface characteristics                  | hot-dip tin-plated   |
| Metal surface terminal point (top layer) | Tin (4 µm - 8 µm Sn)   |
| Metal surface contact area (top layer)   | Tin (4 µm - 8 µm Sn)   |

### Material data - housing

|   |              |
|---|--------------|
| Color (Housing)   | green (6021) |
| Insulating material   | PA           |
| Insulating material group   | I            |
| CTI according to IEC 60112  | 600          |
| Flammability rating according to UL 94                            | V0           |
| Glow wire flammability index GWFI according to EN 60695-2-12      | 850          |
| Glow wire ignition temperature GWIT according to EN 60695-2-13    | 775          |
| Temperature for the ball pressure test according to EN 60695-10-2 | 125 °C       |

# FRONT-MC 1,5/18-ST-3,81 - PCB connector



1850822

<https://www.phoenixcontact.com/us/products/1850822>

## Dimensions

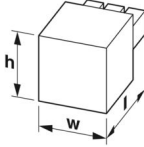
|                     |  |
|---------------------|--|
| Dimensional drawing |  |
| Pitch               | 3.81 mm  |
| Width [w]           | 69.37 mm   |
| Height [h]          | 12.3 mm  |
| Length [l]          | 21.7 mm  |

## Mechanical tests

### Test for conductor damage and slackening

|               |                     |
|---------------|---------------------|
| Specification | IEC 60999-1:1999-11 |
| Result        | Test passed         |

### Pull-out test

|   |  |
|---|--|
| Specification   | IEC 60999-1:1999-11                      |
| Conductor cross-section/conductor type/tractive force setpoint/actual value | 0.14 mm <sup>2</sup> / solid / > 10 N    |
|   | 0.14 mm <sup>2</sup> / flexible / > 10 N |
|   | 1.5 mm <sup>2</sup> / solid / > 40 N     |
|   | 1.5 mm <sup>2</sup> / flexible / > 40 N  |

### Insertion and withdrawal forces

|                                     |                        |
|-------------------------------------|------------------------|
| Specification                       | IEC 60512-13-2:2006-02 |
| Result                              | Test passed            |
| No. of cycles                       | 25                     |
| Insertion strength per pos. approx. | 7 N                    |
| Withdraw strength per pos. approx.  | 5 N                    |

### Torque test

|               |                     |
|---------------|---------------------|
| Specification | IEC 60999-1:1999-11 |
|---------------|---------------------|

### Resistance of inscriptions

|               |                        |
|---------------|------------------------|
| Specification | IEC 60068-2-70:1995-12 |
| Result        | Test passed            |

### Polarization and coding

|               |                        |
|---------------|------------------------|
| Specification | IEC 60512-13-5:2006-02 |
| Result        | Test passed            |

### Visual inspection

|               |                       |
|---------------|-----------------------|
| Specification | IEC 60512-1-1:2002-02 |
| Result        | Test passed           |

# FRONT-MC 1,5/18-ST-3,81 - PCB connector



1850822

<https://www.phoenixcontact.com/us/products/1850822>

## Dimension check

|               |                       |
|---------------|-----------------------|
| Specification | IEC 60512-1-2:2002-02 |
| Result        | Test passed           |

## Environmental and real-life conditions

### Durability test

|  |                       |
|--|-----------------------|
| Specification                                | IEC 60512-9-1:2010-03 |
| Impulse withstand voltage at sea level       | 2.95 kV               |
| Contact resistance $R_1$                     | 1.6 m $\Omega$        |
| Contact resistance $R_2$                     | 1.7 m $\Omega$        |
| Insertion/withdrawal cycles                  | 25                    |
| Insulation resistance, neighboring positions | > 5 M $\Omega$        |

### Climatic test

|                                   |   |
|-----------------------------------|---|
| Specification                     | ISO 6988:1985-02  |
| Corrosive stress                  | 0.2 dm <sup>3</sup> SO <sub>2</sub> on 300 dm <sup>3</sup> /40 °C/1 cycle |
| Thermal stress                    | 100 °C/168 h  |
| Power-frequency withstand voltage | 1.39 kV   |

### Vibration test

|                        |                             |
|------------------------|-----------------------------|
| Specification          | IEC 60068-2-6:2007-12       |
| Frequency              | 10 - 150 - 10 Hz            |
| Sweep speed            | 1 octave/min                |
| Amplitude              | 0.35 mm (10 Hz ... 60.1 Hz) |
| Acceleration           | 5g (60.1 Hz ... 150 Hz)     |
| Test duration per axis | 2.5 h                       |
| Test directions        | X-, Y- and Z-axis           |

### Ambient conditions

|   |   |
|---|---|
| Ambient temperature (storage/transport) | -40 °C ... 70 °C                                    |
| Relative humidity (storage/transport)   | 30 % ... 70 %                                       |
| Ambient temperature (assembly)          | -5 °C ... 100 °C                                    |
| Ambient temperature (operation)         | -40 °C ... 100 °C (dependent on the derating curve) |

## Electrical tests

### Thermal test | Test group C

|                            |                       |
|----------------------------|-----------------------|
| Specification              | IEC 60512-5-1:2002-02 |
| Tested number of positions | 20                    |

### Insulation resistance

|  |                       |
|--|-----------------------|
| Specification                                | IEC 60512-3-1:2002-02 |
| Insulation resistance, neighboring positions | > 5 M $\Omega$        |

### Air clearances and creepage distances |

|               |                     |
|---------------|---------------------|
| Specification | IEC 60664-1:2007-04 |
|---------------|---------------------|

# FRONT-MC 1,5/18-ST-3,81 - PCB connector



1850822

<https://www.phoenixcontact.com/us/products/1850822>

|  |         |
|--|---------|
| Insulating material group                              | I       |
| Comparative tracking index (IEC 60112)                 | CTI 600 |
| Rated insulation voltage (III/3)                       | 160 V   |
| Rated surge voltage (III/3)                            | 2.5 kV  |
| minimum clearance value - non-homogenous field (III/3) | 1.5 mm  |
| minimum creepage distance (III/3)                      | 2 mm    |
| Rated insulation voltage (III/2)                       | 160 V   |
| Rated surge voltage (III/2)                            | 2.5 kV  |
| minimum clearance value - non-homogenous field (III/2) | 1.5 mm  |
| minimum creepage distance (III/2)                      | 1.5 mm  |
| Rated insulation voltage (II/2)                        | 320 V   |
| Rated surge voltage (II/2)                             | 2.5 kV  |
| minimum clearance value - non-homogenous field (II/2)  | 1.5 mm  |
| minimum creepage distance (II/2)                       | 1.6 mm  |

## Packaging specifications

|                   |                     |
|-------------------|---------------------|
| Type of packaging | packed in cardboard |
|-------------------|---------------------|

# FRONT-MC 1,5/18-ST-3,81 - PCB connector



1850822

<https://www.phoenixcontact.com/us/products/1850822>

## Drawings

Dimensional drawing

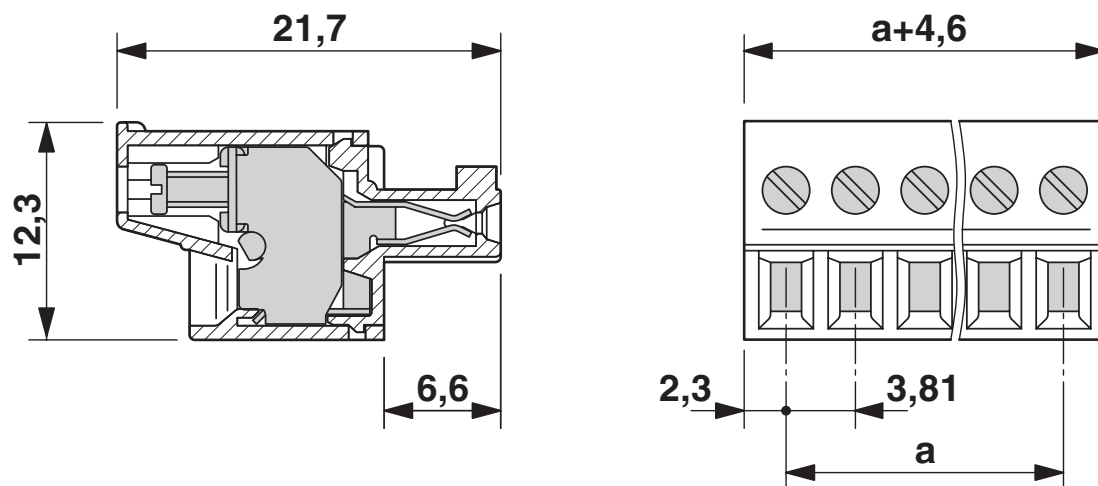

Diagram

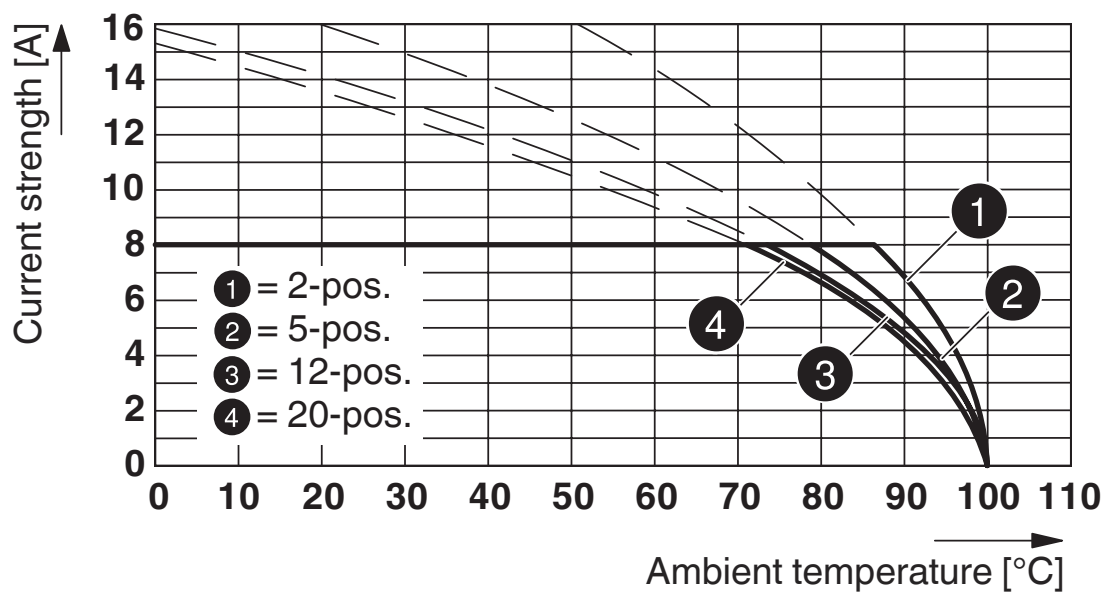

Type: FRONT-MC 1,5/...-ST-3,81 with MCV 1,5/...-G-3,81

1850822

<https://www.phoenixcontact.com/us/products/1850822>



Type: FRONT-MC 1,5/...-ST-3,81 with MCO 1,5/...-GR-3,81



Type: FRONT-MC 1,5/...-ST-3,81 with MCD 1,5/...-G1-3,81

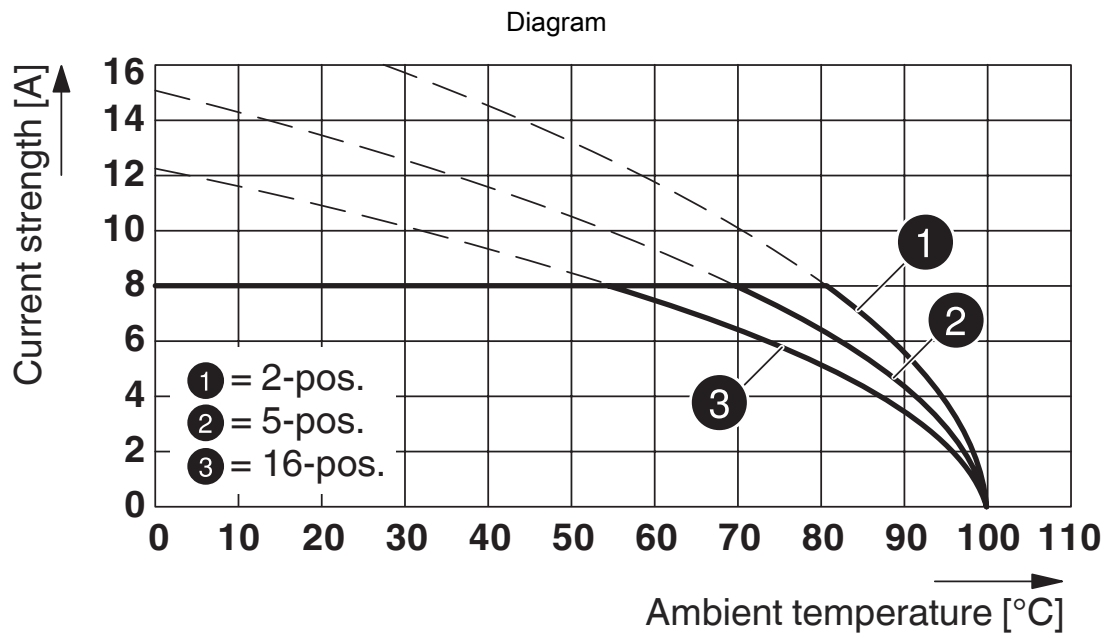

Type: FRONT-MC 1,5/...-ST-3,81 with MCDV 1,5/...-G1-3,81

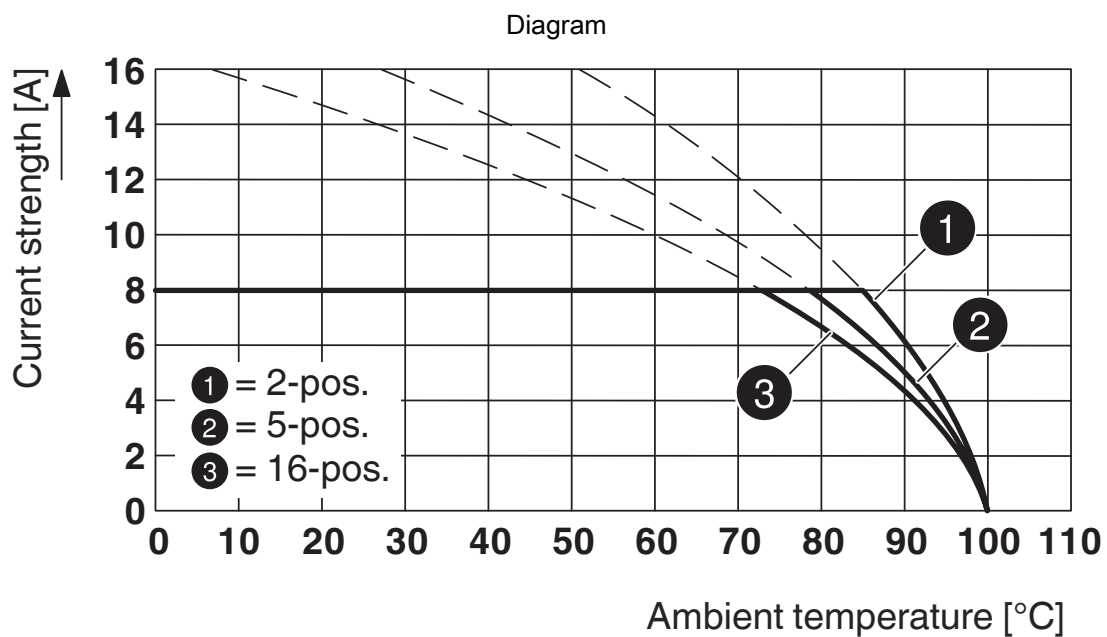

Type: FRONT-MC 1,5/...-ST-3,81 with IMC 1,5/...-ST-3,81

1850822

<https://www.phoenixcontact.com/us/products/1850822>



Type: FRONT-MC 1,5/...-ST-3,81 with MC 1,5/...-G-3,81



Type: FRONT-MC 1,5/...-ST-3,81 with MC 1,5/...-G-3,81 P... THR

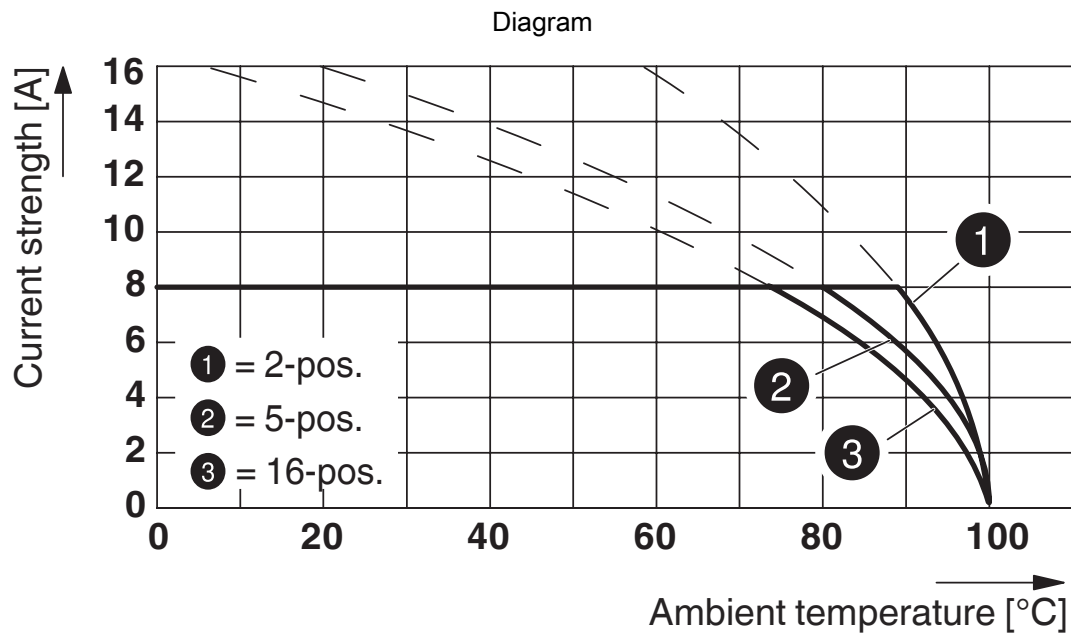

Type: FRONT-MC 1,5/...-ST-3,81 with SMC 1,5/...-G-3,81

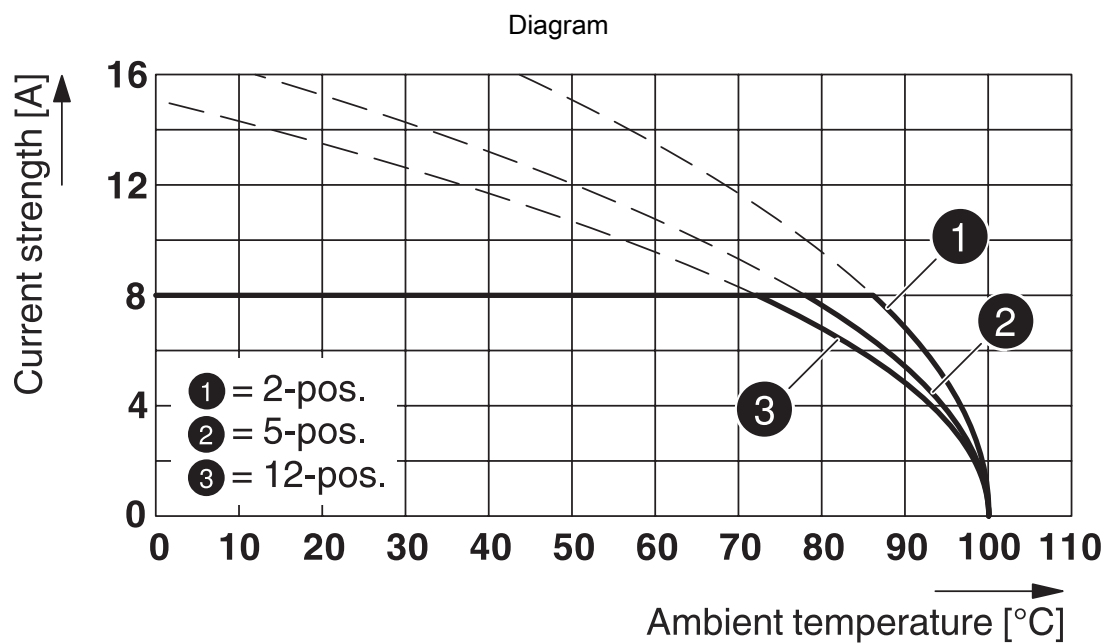

Type: FRONT-MC 1,5/...-ST-3,81 with MCV 1,5/...-G-3,81 P...THR

# FRONT-MC 1,5/18-ST-3,81 - PCB connector



1850822

<https://www.phoenixcontact.com/us/products/1850822>



Type: FRONT-MC 1,5/...-ST-3,81 with MCDV 1,5/...-G-3,81

# FRONT-MC 1,5/18-ST-3,81 - PCB connector



1850822

<https://www.phoenixcontact.com/us/products/1850822>

## Approvals

To download certificates, visit the product detail page: <https://www.phoenixcontact.com/us/products/1850822>

|  <b>CSA</b><br>Approval ID: 2406780 |                       |                       |                   |                             |
|--|-----------------------|-----------------------|-------------------|-----------------------------|
|  | Nominal voltage $U_N$ | Nominal current $I_N$ | Cross section AWG | Cross section $\text{mm}^2$ |
| B  | 300 V                 | 8 A                   | 28 - 16           | -                           |
| D  | 300 V                 | 8 A                   | 28 - 16           | -                           |

|  <b>cULus Recognized</b><br>Approval ID: E60425-20110128 |                       |                       |                   |                             |
|---|-----------------------|-----------------------|-------------------|-----------------------------|
|   | Nominal voltage $U_N$ | Nominal current $I_N$ | Cross section AWG | Cross section $\text{mm}^2$ |
| B   | 300 V                 | 8 A                   | 30 - 16           | -                           |
| D   | 300 V                 | 8 A                   | 30 - 16           | -                           |

# FRONT-MC 1,5/18-ST-3,81 - PCB connector



1850822

<https://www.phoenixcontact.com/us/products/1850822>

## Classifications

### ECLASS

|             |          |
|-------------|----------|
| ECLASS-13.0 | 27460202 |
| ECLASS-15.0 | 27460202 |

### ETIM

|           |          |
|-----------|----------|
| ETIM 10.0 | EC002638 |
|-----------|----------|

### UNSPSC

|             |          |
|-------------|----------|
| UNSPSC 21.0 | 39121400 |
|-------------|----------|

# FRONT-MC 1,5/18-ST-3,81 - PCB connector



1850822

<https://www.phoenixcontact.com/us/products/1850822>

## Environmental product compliance

### EU RoHS

|   |                    |
|---|--------------------|
| Fulfills EU RoHS substance requirements | Yes, No exemptions |
|---|--------------------|

### China RoHS

|  |  |
|--|--|
| Environment friendly use period (EFUP) | EFUP-E                                   |
|  | No hazardous substances above the limits |

### EU REACH SVHC

|                                     |                            |
|-------------------------------------|----------------------------|
| REACH candidate substance (CAS No.) | No substance above 0.1 wt% |
|-------------------------------------|----------------------------|

Phoenix Contact 2026 © - all rights reserved  
<https://www.phoenixcontact.com>

Phoenix Contact USA  
586 Fulling Mill Road  
Middletown, PA 17057, United States  
(+717) 944-1300  
[info@phoenixcon.com](mailto:info@phoenixcon.com)