

MCDV 1,5/16-G1-3,81 - PCB header



1847877

<https://www.phoenixcontact.com/us/products/1847877>

Please be informed that the data shown in this PDF document is generated from our online catalog. Please find the complete data in the user documentation. Our general terms of use for downloads are valid.

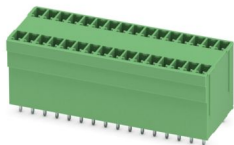

PCB headers, nominal cross section: 1.5 mm², color: green, nominal current: 8 A, rated voltage (III/2): 160 V, contact surface: Sn, contact connection type: Pin, number of potentials: 32, number of rows: 2, number of positions: 16, number of connections: 32, product range: MCDV 1,5/...-G1, pitch: 3.81 mm, mounting: Wave soldering, pin layout: Linear pinning, solder pin [P]: 3.4 mm, number of solder pins per potential: 1, plug-in system: COMBICON MC 1,5, Pin connector pattern alignment: Standard, locking: without, mounting method: without, type of packaging: packed in cardboard, In combination with MCV plug components, both an MCVW and an MCVR plug must be used.

Your advantages

- Well-known mounting principle allows worldwide use
- Vertical connection enables multi-row arrangement on the PCB
- Maximum flexibility when it comes to device design – one header for connectors with different connection technologies

Commercial data

| | |
|--------------------------------------|---------------|
| Item number | 1847877 |
| Packing unit | 20 pc |
| Minimum order quantity | 50 pc |
| Sales key | AA02 |
| Product key | AABSHF |
| GTIN | 4017918113995 |
| Weight per piece (including packing) | 18.88 g |
| Weight per piece (excluding packing) | 17.543 g |
| Customs tariff number | 85366930 |
| Country of origin | DE |

Technical data

Product properties

| | |
|---------------------------|-----------------------|
| Product type | PCB headers |
| Product family | MCDV 1,5/..-G1 |
| Product line | COMBICON Connectors S |
| Type | Standard |
| Number of positions | 16 |
| Pitch | 3.81 mm |
| Number of connections | 32 |
| Number of rows | 2 |
| Number of potentials | 32 |
| Mounting type | without |
| Pin layout | Linear pinning |
| Solder pins per potential | 1 |

Electrical properties

Properties

| | |
|-----------------------------|--------|
| Nominal current I_N | 8 A |
| Nominal voltage U_N | 160 V |
| Contact resistance | 1.7 mΩ |
| Rated voltage (III/3) | 160 V |
| Rated surge voltage (III/3) | 2.5 kV |
| Rated voltage (III/2) | 160 V |
| Rated surge voltage (III/2) | 2.5 kV |
| Rated voltage (II/2) | 320 V |
| Rated surge voltage (II/2) | 2.5 kV |

Mounting

| | |
|---------------|----------------|
| Mounting type | Wave soldering |
| Pin layout | Linear pinning |

Material specifications

Material data - contact

| | |
|---|--|
| Note | WEEE/RoHS-compliant, free of whiskers according to IEC 60068-2-82/JEDEC JESD 201 |
| Contact material | Cu alloy |
| Surface characteristics | Tin-plated |
| Metal surface contact area (top layer) | Tin (3 μm - 5 μm Sn) |
| Metal surface contact area (middle layer) | Nickel (1 μm - 3 μm Ni) |
| Metal surface soldering area (top layer) | Tin (3 μm - 5 μm Sn) |
| Metal surface soldering area (middle layer) | Nickel (1 μm - 3 μm Ni) |

MCDV 1,5/16-G1-3,81 - PCB header

1847877

<https://www.phoenixcontact.com/us/products/1847877>

Material data - housing

| | |
|---|--------------|
| Color (Housing) | green (6021) |
| Insulating material | PA |
| Insulating material group | I |
| CTI according to IEC 60112 | 600 |
| Flammability rating according to UL 94 | V0 |
| Glow wire flammability index GWFI according to EN 60695-2-12 | 850 |
| Glow wire ignition temperature GWIT according to EN 60695-2-13 | 775 |
| Temperature for the ball pressure test according to EN 60695-10-2 | 125 °C |

Dimensions

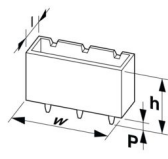
| | |
|-----------------------|---|
| Dimensional drawing |  |
| Pitch | 3.81 mm |
| Width [w] | 62.35 mm |
| Height [h] | 25.3 mm |
| Length [l] | 22.7 mm |
| Installed height | 21.9 mm |
| Solder pin length [P] | 3.4 mm |
| Pin dimensions | 0.8 x 0.8 mm |

PCB design

| | |
|---------------|----------|
| Pin spacing | 15.24 mm |
| Hole diameter | 1.2 mm |

Mechanical tests

Visual inspection

| | |
|---------------|-----------------------|
| Specification | IEC 60512-1-1:2002-02 |
| Result | Test passed |

Dimension check

| | |
|---------------|-----------------------|
| Specification | IEC 60512-1-2:2002-02 |
| Result | Test passed |

Resistance of inscriptions

| | |
|---------------|------------------------|
| Specification | IEC 60068-2-70:1995-12 |
| Result | Test passed |

Polarization and coding

| | |
|---------------|------------------------|
| Specification | IEC 60512-13-5:2006-02 |
|---------------|------------------------|

MCDV 1,5/16-G1-3,81 - PCB header



1847877

<https://www.phoenixcontact.com/us/products/1847877>

| | |
|---|------------------------|
| Result | Test passed |
| Contact holder in insert | |
| Specification | IEC 60512-15-1:2008-05 |
| Contact holder in insert Requirements >20 N | Test passed |
| Insertion and withdrawal forces | |
| Specification | IEC 60512-13-2:2006-02 |
| Result | Test passed |
| No. of cycles | 25 |
| Insertion strength per pos. approx. | 8 N |
| Withdraw strength per pos. approx. | 6 N |

Electrical tests

Thermal test | Test group C

| | |
|----------------------------|-----------------------|
| Specification | IEC 60512-5-1:2002-02 |
| Tested number of positions | 16 |

Insulation resistance

| | |
|--|-----------------------|
| Specification | IEC 60512-3-1:2002-02 |
| Insulation resistance, neighboring positions | > 5 MΩ |

Air clearances and creepage distances |

| | |
|--|---------------------|
| Specification | IEC 60664-1:2007-04 |
| Insulating material group | I |
| Comparative tracking index (IEC 60112) | CTI 600 |
| Rated insulation voltage (III/3) | 160 V |
| Rated surge voltage (III/3) | 2.5 kV |
| minimum clearance value - non-homogenous field (III/3) | 1.5 mm |
| minimum creepage distance (III/3) | 2 mm |
| Rated insulation voltage (III/2) | 160 V |
| Rated surge voltage (III/2) | 2.5 kV |
| minimum clearance value - non-homogenous field (III/2) | 1.5 mm |
| minimum creepage distance (III/2) | 1.5 mm |
| Rated insulation voltage (II/2) | 320 V |
| Rated surge voltage (II/2) | 2.5 kV |
| minimum clearance value - non-homogenous field (II/2) | 1.5 mm |
| minimum creepage distance (II/2) | 1.6 mm |

Environmental and real-life conditions

Durability test

| | |
|--|-----------------------|
| Specification | IEC 60512-9-1:2010-03 |
| Impulse withstand voltage at sea level | 2.95 kV |
| Contact resistance R ₁ | 1.7 mΩ |

MCDV 1,5/16-G1-3,81 - PCB header



1847877

<https://www.phoenixcontact.com/us/products/1847877>

| | |
|--|----------------|
| Contact resistance R_2 | 2 m Ω |
| Contact resistance R_2 2nd level | 1.9 m Ω |
| Insertion/withdrawal cycles | 25 |
| Insulation resistance, neighboring positions | > 5 M Ω |

Climatic test

| | |
|-----------------------------------|---|
| Specification | ISO 6988:1985-02 |
| Corrosive stress | 0.2 dm ³ SO ₂ on 300 dm ³ /40 °C/1 cycle |
| Thermal stress | 100 °C/168 h |
| Power-frequency withstand voltage | 1.39 kV |

Vibration test

| | |
|------------------------|-----------------------------|
| Specification | IEC 60068-2-6:2007-12 |
| Frequency | 10 - 150 - 10 Hz |
| Sweep speed | 1 octave/min |
| Amplitude | 0.35 mm (10 Hz ... 60.1 Hz) |
| Acceleration | 5g (60.1 Hz ... 150 Hz) |
| Test duration per axis | 2.5 h |
| Test directions | X-, Y- and Z-axis |

Ambient conditions

| | |
|---|---|
| Ambient temperature (storage/transport) | -40 °C ... 70 °C |
| Relative humidity (storage/transport) | 30 % ... 70 % |
| Ambient temperature (assembly) | -5 °C ... 100 °C |
| Ambient temperature (operation) | -40 °C ... 100 °C (dependent on the derating curve) |

Packaging specifications

| | |
|-------------------|---------------------|
| Type of packaging | packed in cardboard |
|-------------------|---------------------|

MCDV 1,5/16-G1-3,81 - PCB header

1847877

<https://www.phoenixcontact.com/us/products/1847877>

Drawings

Dimensional drawing

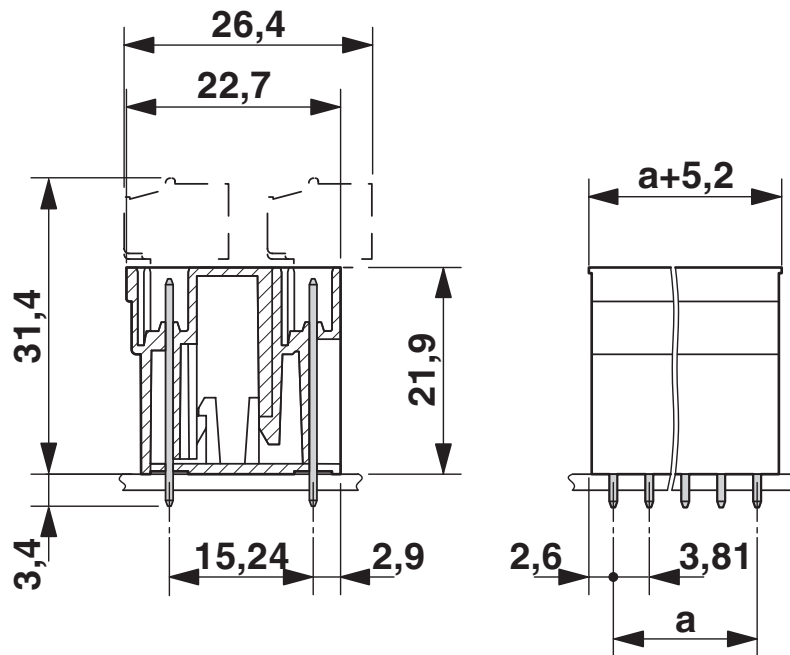

Diagram



Type: MC 1,5/...-ST-3,81 with MCDV 1,5/...-G1-3,81

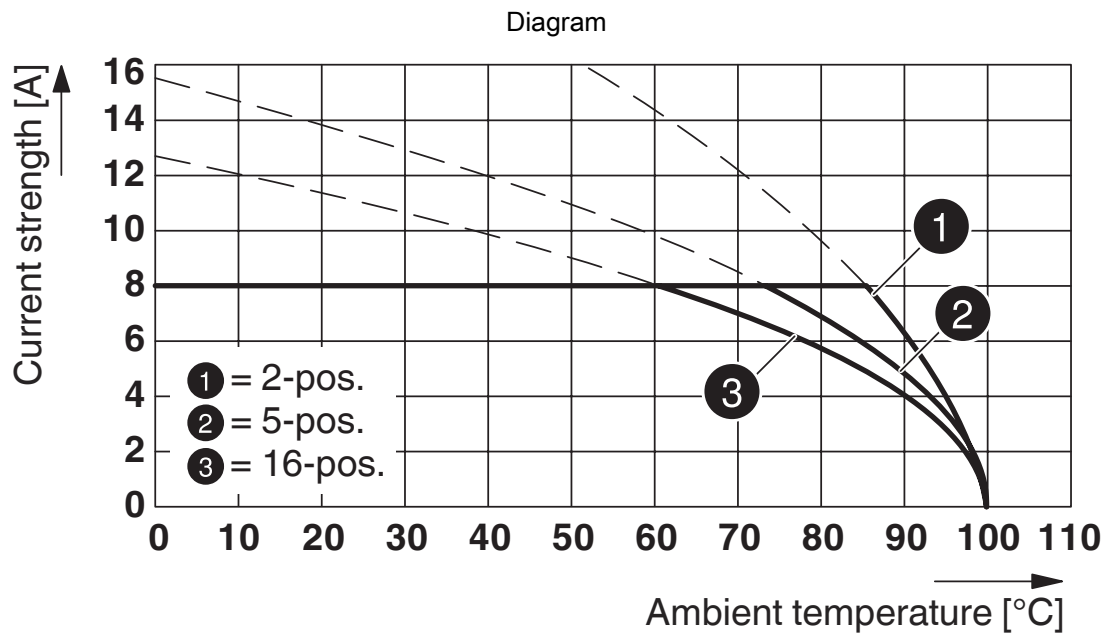

Type: FK-MCP 1,5/...-ST-3,81 with MCDV 1,5/...-G1-3,81

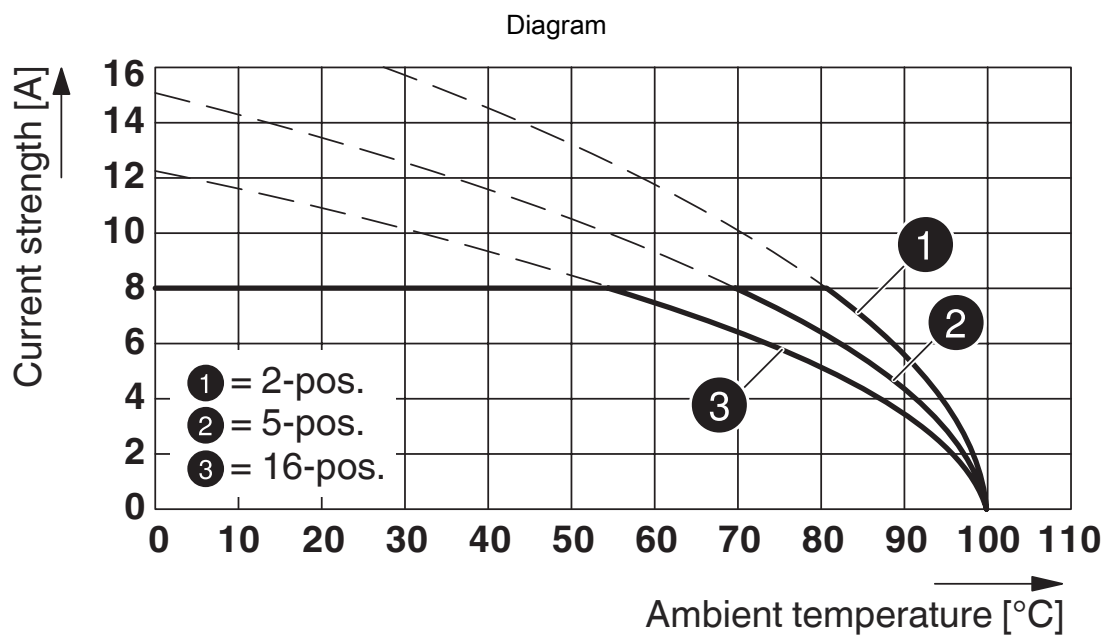

Type: FRONT-MC 1,5/...-ST-3,81 with MCDV 1,5/...-G1-3,81



Type: MCV(W/R) 1,5/...-ST-3,81 with MCDV 1,5/...-G1-3,81

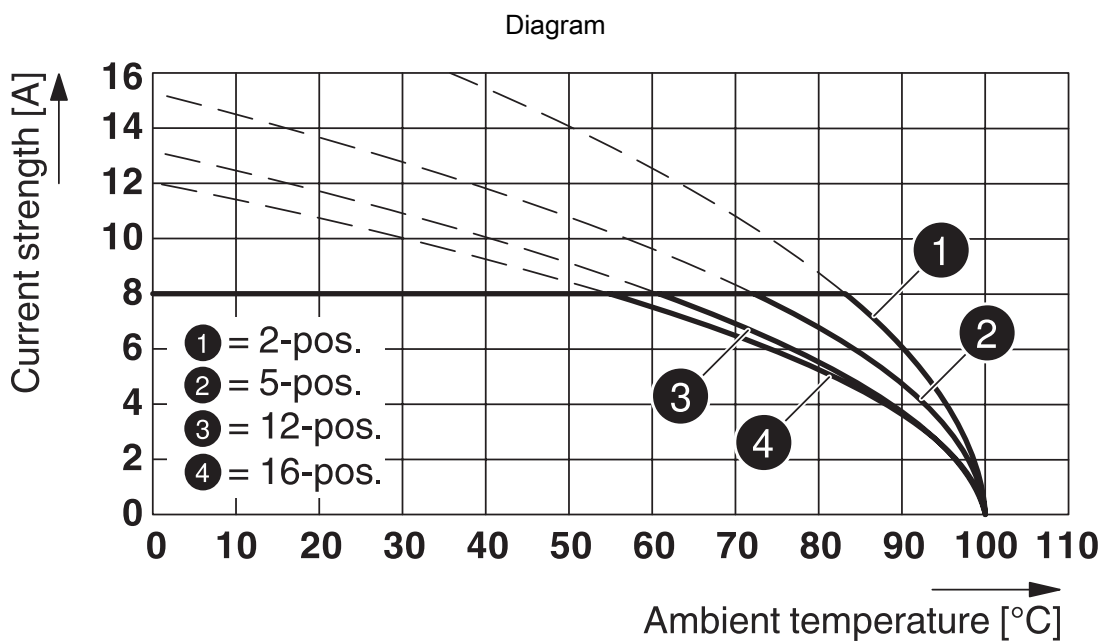

Type: FMC 1,5/...-ST-3,81 with MCDV 1,5/...-G1-3,81

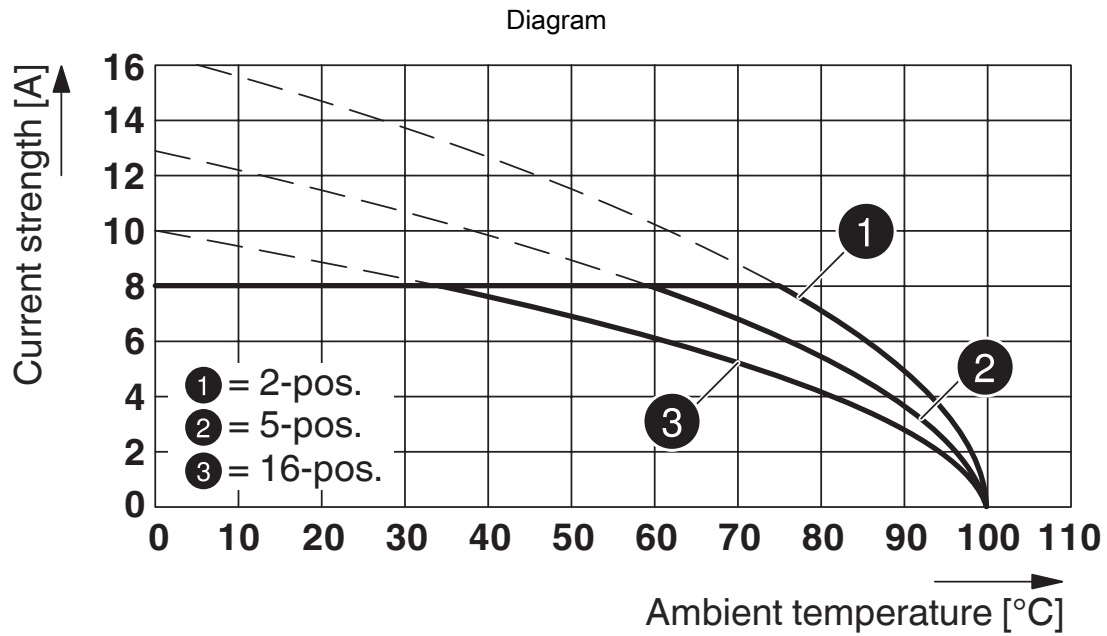

Type: MCV(W/R) 1,5/...-ST-3,81 with MCDV 1,5/...-G1-3,81

Drilling plan/solder pad geometry



MCDV 1,5/16-G1-3,81 - PCB header



1847877

<https://www.phoenixcontact.com/us/products/1847877>

Approvals

To download certificates, visit the product detail page: <https://www.phoenixcontact.com/us/products/1847877>

|  CSA Approval ID: 13631 | | | | |
|--|-----------------------|-----------------------|-------------------|-----------------------------|
| | Nominal voltage U_N | Nominal current I_N | Cross section AWG | Cross section mm^2 |
| B | 300 V | 8 A | - | - |
| D | 300 V | 8 A | - | - |

|  cULus Recognized Approval ID: E60425-20110128 | | | | |
|---|-----------------------|-----------------------|-------------------|-----------------------------|
| | Nominal voltage U_N | Nominal current I_N | Cross section AWG | Cross section mm^2 |
| B | 300 V | 8 A | - | - |
| D | 300 V | 8 A | - | - |

|  VDE Zeichengenehmigung Approval ID: 40011723 | | | | |
|--|-----------------------|-----------------------|-------------------|-----------------------------|
| | Nominal voltage U_N | Nominal current I_N | Cross section AWG | Cross section mm^2 |
| keine | 160 V | 8 A | - | - |

MCDV 1,5/16-G1-3,81 - PCB header



1847877

<https://www.phoenixcontact.com/us/products/1847877>

Classifications

ECLASS

| | |
|-------------|----------|
| ECLASS-13.0 | 27460201 |
| ECLASS-15.0 | 27460201 |

ETIM

| | |
|-----------|----------|
| ETIM 10.0 | EC002637 |
|-----------|----------|

UNSPSC

| | |
|-------------|----------|
| UNSPSC 21.0 | 39121400 |
|-------------|----------|

MCDV 1,5/16-G1-3,81 - PCB header



1847877

<https://www.phoenixcontact.com/us/products/1847877>

Environmental product compliance

EU RoHS

| | |
|---|--------------------|
| Fulfills EU RoHS substance requirements | Yes, No exemptions |
|---|--------------------|

China RoHS

| | |
|--|--|
| Environment friendly use period (EFUP) | EFUP-E |
| | No hazardous substances above the limits |

EU REACH SVHC

| | |
|-------------------------------------|----------------------------|
| REACH candidate substance (CAS No.) | No substance above 0.1 wt% |
|-------------------------------------|----------------------------|

Phoenix Contact 2026 © - all rights reserved
<https://www.phoenixcontact.com>

Phoenix Contact USA
586 Fulling Mill Road
Middletown, PA 17057, United States
(+717) 944-1300
info@phoenixcon.com