

# DFMC 0,5/13-ST-2,54 - PCB connector



1844688

<https://www.phoenixcontact.com/us/products/1844688>

Please be informed that the data shown in this PDF document is generated from our online catalog. Please find the complete data in the user documentation. Our general terms of use for downloads are valid.

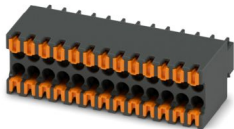

PCB connector, nominal cross section: 0.5 mm<sup>2</sup>, color: black, nominal current: 6 A, rated voltage (III/2): 160 V, contact surface: Au, contact connection type: Socket, number of potentials: 26, number of rows: 2, number of positions: 13, number of connections: 26, product range: DFMC 0,5/..-ST, pitch: 2.54 mm, connection method: Push-in spring connection, conductor/PCB connection direction: 0 °, plug-in system: COMBICON DFMC 0,5, locking: without, mounting method: without, type of packaging: packed in cardboard

## Your advantages

- Gold-plated contacts ensure transfer quality remains stable over the long term
- Time saving push-in connection, tools not required
- Defined contact force ensures that contact remains stable over the long term
- Intuitive operation due to color-coded actuating push button
- Optimized for tight installation situations: operation and conductor connection from one direction

## Commercial data

Item number	1844688
Packing unit	50 pc
Minimum order quantity	50 pc
Sales key	AA01
Product key	AAAFDA
GTIN	4046356964364
Weight per piece (including packing)	6.64 g
Weight per piece (excluding packing)	2.22 g
Customs tariff number	85366990
Country of origin	PL

# DFMC 0,5/13-ST-2,54 - PCB connector



1844688

<https://www.phoenixcontact.com/us/products/1844688>

## Technical data

### Product properties

Product type	PCB connector
Product family	DFMC 0,5/..-ST
Product line	COMBICON Connectors XS
Type	Standard
Number of positions	13
Pitch	2.54 mm
Number of connections	26
Number of rows	2
Number of potentials	26
Mounting type	without

### Electrical properties

#### Properties

Nominal current $I_N$	6 A
Nominal voltage $U_N$	160 V
Contact resistance	2.7 m $\Omega$
Rated voltage (III/3)	32 V
Rated surge voltage (III/3)	0.8 kV
Rated voltage (III/2)	160 V
Rated surge voltage (III/2)	2.5 kV
Rated voltage (II/2)	160 V
Rated surge voltage (II/2)	1.5 kV

### Connection data

#### Connection technology

Type	Standard
Connector system	COMBICON DFMC 0,5
Nominal cross section	0.5 mm <sup>2</sup>
Contact connection type	Socket

#### Interlock

Locking type	without
Mounting type	without

#### Conductor connection

Connection method	Push-in spring connection
Conductor/PCB connection direction	0 °
Conductor cross-section rigid	0.14 mm <sup>2</sup> ... 0.5 mm <sup>2</sup>
Conductor cross-section flexible	0.14 mm <sup>2</sup> ... 0.5 mm <sup>2</sup>
Conductor cross-section AWG	26 ... 20

# DFMC 0,5/13-ST-2,54 - PCB connector



1844688

<https://www.phoenixcontact.com/us/products/1844688>

Conductor cross-section, flexible, with ferrule, without plastic sleeve	0.25 mm <sup>2</sup> ... 0.34 mm <sup>2</sup>
Conductor cross-section, flexible, with ferrule, with plastic sleeve	0.14 mm <sup>2</sup> ... 0.25 mm <sup>2</sup>
Cylindrical gauge a x b / diameter	- / 1.2 mm
Stripping length	7 mm

## Material specifications

### Material data - contact

Note	WEEE/RoHS-compliant, free of whiskers according to IEC 60068-2-82/JEDEC JESD 201
Contact material	Cu alloy
Surface characteristics	partially gold-plated
Metal surface terminal point (top layer)	Tin (5 µm - 7 µm Sn)
Metal surface terminal point (middle layer)	Nickel (2 µm - 3 µm Ni)
Metal surface contact area (top layer)	Gold (min. 0.25 µm Au)
Metal surface contact area (middle layer)	Nickel (2 µm - 3 µm Ni)

### Material data - housing

Color (Housing)	black (9005)
Insulating material	LCP
Insulating material group	IIIa
CTI according to IEC 60112	175
Flammability rating according to UL 94	V0

### Material data – actuating element

Color (Actuating element)	orange (2003)
Insulating material	LCP
Insulating material group	IIIa
CTI according to IEC 60112	175
Flammability rating according to UL 94	V0

## Dimensions

Dimensional drawing	
Pitch	2.54 mm
Width [w]	33.52 mm
Height [h]	10.5 mm
Length [l]	15.85 mm

## Notes

# DFMC 0,5/13-ST-2,54 - PCB connector



1844688

<https://www.phoenixcontact.com/us/products/1844688>

Notes on operation	In accordance with IEC 61984, COMBICON connectors have no switching power (COC). During designated use, they must not be plugged in or disconnected when carrying voltage or under load.
--------------------	--

## Mechanical tests

### Conductor connection

Specification	IEC 60999-1:1999-11
Result	Test passed

### Test for conductor damage and slackening

Specification	IEC 60999-1:1999-11
Result	Test passed

### Repeated connection and disconnection

Specification	IEC 60999-1:1999-11
Result	Test passed

### Pull-out test

Specification	IEC 60999-1:1999-11
Conductor cross-section/conductor type/tractive force setpoint/actual value	0.14 mm <sup>2</sup> / solid / > 10 N
	0.14 mm <sup>2</sup> / flexible / > 10 N
	0.5 mm <sup>2</sup> / solid / > 20 N
	0.5 mm <sup>2</sup> / flexible / > 20 N

### Insertion and withdrawal forces

Specification	IEC 60512-13-2:2006-02
Result	Test passed
No. of cycles	100
Insertion strength per pos. approx.	2 N
Withdraw strength per pos. approx.	1 N

### Resistance of inscriptions

Specification	IEC 60068-2-70:1995-12
Result	Test passed

### Polarization and coding

Specification	IEC 60512-13-5:2006-02
Result	Test passed

### Visual inspection

Specification	IEC 60512-1-1:2002-02
Result	Test passed

### Dimension check

Specification	IEC 60512-1-2:2002-02
Result	Test passed

## Environmental and real-life conditions

# DFMC 0,5/13-ST-2,54 - PCB connector



1844688

<https://www.phoenixcontact.com/us/products/1844688>

## Durability test

Specification	IEC 60512-9-1:2010-03
Impulse withstand voltage at sea level	2.95 kV
Contact resistance R <sub>1</sub>	2.7 mΩ
Contact resistance R <sub>2</sub>	2.9 mΩ
Contact resistance R <sub>2</sub> 2nd level	3.1 mΩ
Insertion/withdrawal cycles	100
Insulation resistance, neighboring positions	> 5 MΩ

## Climatic test

Specification	DIN 50018:2013-05
Corrosive stress	1.0 dm <sup>3</sup> SO <sub>2</sub> on 300 dm <sup>3</sup> /40 °C/3 cycles
Thermal stress	100 °C/168 h
Power-frequency withstand voltage	1.39 kV

## Vibration test

Specification	IEC 60068-2-6:2007-12
Frequency	10 - 500 - 10 Hz
Sweep speed	1 octave/min
Amplitude	0.35 mm (10 Hz ... 60.1 Hz)
Acceleration	5g (60.1 Hz ... 500 Hz)
Test duration per axis	2 h
Test directions	X-, Y- and Z-axis

## Ambient conditions

Ambient temperature (storage/transport)	-40 °C ... 70 °C
Relative humidity (storage/transport)	30 % ... 70 %
Ambient temperature (assembly)	-5 °C ... 100 °C
Ambient temperature (operation)	-40 °C ... 100 °C (dependent on the derating curve)

## Electrical tests

### Thermal test | Test group C

Specification	IEC 60512-5-1:2002-02
Tested number of positions	16

### Insulation resistance

Specification	IEC 60512-3-1:2002-02
Insulation resistance, neighboring positions	> 5 MΩ

### Temperature cycles

Specification	IEC 60999-1:1999-11
Result	Test passed

### Air clearances and creepage distances |

Specification	IEC 60664-1:2007-04
Insulating material group	IIIa

# DFMC 0,5/13-ST-2,54 - PCB connector



1844688

<https://www.phoenixcontact.com/us/products/1844688>

Comparative tracking index (IEC 60112)	CTI 175
Rated insulation voltage (III/3)	32 V
Rated surge voltage (III/3)	0.8 kV
minimum clearance value - non-homogenous field (III/3)	0.8 mm
minimum creepage distance (III/3)	1.3 mm
Rated insulation voltage (III/2)	160 V
Rated surge voltage (III/2)	2.5 kV
minimum clearance value - non-homogenous field (III/2)	1.5 mm
minimum creepage distance (III/2)	1.6 mm
Rated insulation voltage (II/2)	160 V
Rated surge voltage (II/2)	1.5 kV
minimum clearance value - non-homogenous field (II/2)	0.5 mm
minimum creepage distance (II/2)	1.6 mm

## Packaging specifications

Type of packaging	packed in cardboard
-------------------	---------------------

Drawings

Diagram



Type: DFMC 0,5/...-ST-2,54 with DMC 0,5/...-G1-2,54 P...THR R...

Diagram



Type: DFMC 0,5/...-ST-2,54 with DMCV 0,5/...-G1-2,54 P... THRR...

# DFMC 0,5/13-ST-2,54 - PCB connector



1844688

<https://www.phoenixcontact.com/us/products/1844688>



Type: DFMC 0,5/...-ST-2,54 with DMC 0,5/...-G1-2,54 SMD R...



Type: DFMC 0,5/...-ST-2,54 with DMCV 0,5/...-G1-2,54 SMD R...

# DFMC 0,5/13-ST-2,54 - PCB connector





1844688

<https://www.phoenixcontact.com/us/products/1844688>

## Approvals

To download certificates, visit the product detail page: <https://www.phoenixcontact.com/us/products/1844688>

 <b>cULus Recognized</b> Approval ID: E60425-19920306				
	Nominal voltage $U_N$	Nominal current $I_N$	Cross section AWG	Cross section $\text{mm}^2$
<b>B</b>				
Field wiring	150 V	5 A	26 - 20	-
Factory wiring	150 V	6 A	26 - 20	-
<b>C</b>				
Factory wiring	50 V	6 A	26 - 20	-

 <b>VDE report with production monitoring</b> Approval ID: 40042389				
	Nominal voltage $U_N$	Nominal current $I_N$	Cross section AWG	Cross section $\text{mm}^2$
keine				
	160 V	6 A	-	0.14 - 0.5

# DFMC 0,5/13-ST-2,54 - PCB connector



1844688

<https://www.phoenixcontact.com/us/products/1844688>

## Classifications

### ECLASS

ECLASS-13.0	27460202
ECLASS-15.0	27460202

### ETIM

ETIM 10.0	EC002638
-----------	----------

### UNSPSC

UNSPSC 21.0	39121400
-------------	----------

# DFMC 0,5/13-ST-2,54 - PCB connector



1844688

<https://www.phoenixcontact.com/us/products/1844688>

## Environmental product compliance

### EU RoHS

Fulfills EU RoHS substance requirements	Yes, No exemptions
---	--------------------

### China RoHS

Environment friendly use period (EFUP)	EFUP-E
	No hazardous substances above the limits

### EU REACH SVHC

REACH candidate substance (CAS No.)	No substance above 0.1 wt%
-------------------------------------	----------------------------

Phoenix Contact 2026 © - all rights reserved  
<https://www.phoenixcontact.com>

Phoenix Contact USA  
586 Fulling Mill Road  
Middletown, PA 17057, United States  
(+717) 944-1300  
[info@phoenixcon.com](mailto:info@phoenixcon.com)