

# MCV 1,5/14-GF-3,5 - PCB header



1843347

<https://www.phoenixcontact.com/us/products/1843347>

Please be informed that the data shown in this PDF document is generated from our online catalog. Please find the complete data in the user documentation. Our general terms of use for downloads are valid.

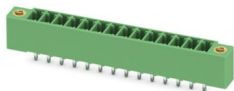

PCB headers, nominal cross section: 1.5 mm<sup>2</sup>, color: green, nominal current: 8 A, rated voltage (III/2): 160 V, contact surface: Sn, contact connection type: Pin, number of potentials: 14, number of rows: 1, number of positions: 14, number of connections: 14, product range: MCV 1,5/..-GF, pitch: 3.5 mm, mounting: Wave soldering, pin layout: Linear pinning, solder pin [P]: 3.4 mm, number of solder pins per potential: 1, plug-in system: COMBICON MC 1,5, Pin connector pattern alignment: Standard, locking: Screw locking mechanism, mounting method: Threaded flange, type of packaging: packed in cardboard

## Your advantages

- Well-known mounting principle allows worldwide use
- Screwable flange for superior mechanical stability
- Vertical connection enables multi-row arrangement on the PCB
- Maximum flexibility when it comes to device design – one header for connectors with different connection technologies

## Commercial data

Item number	1843347
Packing unit	50 pc
Minimum order quantity	50 pc
Sales key	AA02
Product key	AABSAF
GTIN	4017918112530
Weight per piece (including packing)	4.67 g
Weight per piece (excluding packing)	4.22 g
Customs tariff number	85366930
Country of origin	DE

# MCV 1,5/14-GF-3,5 - PCB header



1843347

<https://www.phoenixcontact.com/us/products/1843347>

## Technical data

### Product properties

Product type	PCB headers
Product family	MCV 1,5/..-GF
Product line	COMBICON Connectors S
Type	Standard
Number of positions	14
Pitch	3.5 mm
Number of connections	14
Number of rows	1
Number of potentials	14
Mounting type	Threaded flange
Pin layout	Linear pinning
Solder pins per potential	1

### Electrical properties

#### Properties

Nominal current $I_N$	8 A
Nominal voltage $U_N$	160 V
Contact resistance	2.3 m $\Omega$
Rated voltage (III/3)	160 V
Rated surge voltage (III/3)	2.5 kV
Rated voltage (III/2)	160 V
Rated surge voltage (III/2)	2.5 kV
Rated voltage (II/2)	250 V
Rated surge voltage (II/2)	2.5 kV

### Mounting

Mounting type	Wave soldering
Pin layout	Linear pinning

#### Flange

Tightening torque	0.3 Nm
-------------------	--------

### Material specifications

#### Material data - contact

Note	WEEE/RoHS-compliant, free of whiskers according to IEC 60068-2-82/JEDEC JESD 201
Contact material	Cu alloy
Surface characteristics	Tin-plated
Metal surface contact area (top layer)	Tin (3 $\mu\text{m}$ - 5 $\mu\text{m}$ Sn)
Metal surface contact area (middle layer)	Nickel (1.3 $\mu\text{m}$ - 3 $\mu\text{m}$ Ni)

# MCV 1,5/14-GF-3,5 - PCB header

1843347

<https://www.phoenixcontact.com/us/products/1843347>

Metal surface soldering area (top layer)	Tin (3 $\mu\text{m}$ - 5 $\mu\text{m}$ Sn)
Metal surface soldering area (middle layer)	Nickel (1.3 $\mu\text{m}$ - 3 $\mu\text{m}$ Ni)

## Material data - housing

Color (Housing)	green (6021)
Insulating material	PBT
Insulating material group	IIIa
CTI according to IEC 60112	225
Flammability rating according to UL 94	V0

## Dimensions

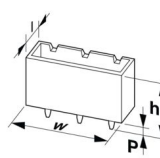
Dimensional drawing	
Pitch	3.5 mm
Width [w]	59.3 mm
Height [h]	12.6 mm
Length [l]	7.25 mm
Installed height	9.2 mm
Solder pin length [P]	3.4 mm
Pin dimensions	0.8 x 0.8 mm

## PCB design

Hole diameter	1.2 mm
---------------	--------

## Mechanical tests

### Visual inspection

Specification	IEC 60512-1-1:2002-02
Result	Test passed

### Dimension check

Specification	IEC 60512-1-2:2002-02
Result	Test passed

### Resistance of inscriptions

Specification	IEC 60068-2-70:1995-12
Result	Test passed

### Polarization and coding

Specification	IEC 60512-13-5:2006-02
Result	Test passed

### Contact holder in insert

Specification	IEC 60512-15-1:2008-05
---------------	------------------------

# MCV 1,5/14-GF-3,5 - PCB header



1843347

<https://www.phoenixcontact.com/us/products/1843347>

Contact holder in insert Requirements >20 N	Test passed
--	-------------

## Insertion and withdrawal forces

Specification	IEC 60512-13-2:2006-02
Result	Test passed
No. of cycles	25
Insertion strength per pos. approx.	5 N
Withdraw strength per pos. approx.	4 N

## Electrical tests

### Thermal test | Test group C

Specification	IEC 60512-5-1:2002-02
Tested number of positions	16

### Insulation resistance

Specification	IEC 60512-3-1:2002-02
Insulation resistance, neighboring positions	> 5 MΩ

### Air clearances and creepage distances |

Specification	IEC 60664-1:2007-04
Insulating material group	IIIa
Comparative tracking index (IEC 60112)	CTI 225
Rated insulation voltage (III/3)	160 V
Rated surge voltage (III/3)	2.5 kV
minimum clearance value - non-homogenous field (III/3)	1.5 mm
minimum creepage distance (III/3)	2.5 mm
Rated insulation voltage (III/2)	160 V
Rated surge voltage (III/2)	2.5 kV
minimum clearance value - non-homogenous field (III/2)	1.5 mm
minimum creepage distance (III/2)	1.6 mm
Rated insulation voltage (II/2)	250 V
Rated surge voltage (II/2)	2.5 kV
minimum clearance value - non-homogenous field (II/2)	1.5 mm
minimum creepage distance (II/2)	2.5 mm

## Environmental and real-life conditions

### Durability test

Specification	IEC 60512-9-1:2010-03
Impulse withstand voltage at sea level	2.95 kV
Contact resistance R <sub>1</sub>	2.3 mΩ
Contact resistance R <sub>2</sub>	2.3 mΩ
Insertion/withdrawal cycles	25
Insulation resistance, neighboring positions	> 5 MΩ

# MCV 1,5/14-GF-3,5 - PCB header



1843347

<https://www.phoenixcontact.com/us/products/1843347>

## Climatic test

Specification	EN ISO 22479:2022-06
Corrosive stress	0.2 dm <sup>3</sup> SO <sub>2</sub> on 300 dm <sup>3</sup> /40 °C/1 cycle
Thermal stress	105 °C/168 h
Power-frequency withstand voltage	1.39 kV

## Vibration test

Specification	IEC 60068-2-6:2007-12
Frequency	10 - 150 - 10 Hz
Sweep speed	1 octave/min
Amplitude	0.35 mm (10 Hz ... 60.1 Hz)
Acceleration	5g (60.1 Hz ... 150 Hz)
Test duration per axis	2.5 h
Test directions	X-, Y- and Z-axis

## Shocks

Specification	IEC 60068-2-27:2008-02
Pulse shape	Semi-sinusoidal
Acceleration	30g
Shock duration	18 ms
Test directions	X-, Y- and Z-axis (pos. and neg.)

## Railway application: Oscillation/broadband noise

Specification	DIN EN 50155 (VDE 0115-200):2022-06 IEC 61373:2010-05
Spectrum	Long life test category 1, class B, body mounted
Frequency	f <sub>1</sub> = 5 Hz to f <sub>2</sub> = 150 Hz
ASD level	0.964 (m/s <sup>2</sup> ) <sup>2</sup> /Hz
Acceleration	0.572 g
Test duration per axis	5 h
Test directions	X-, Y- and Z-axis
Contact interruption	< 1 µs
Result	Test passed

## Railway application: Shocks

Specification	DIN EN 50155 (VDE 0115-200):2022-06 IEC 61373:2010-05
Pulse shape	Semi-sinusoidal
Acceleration	30g
Shock duration	18 ms
Number of shocks per direction	3
Test directions	X-, Y- and Z-axis (pos. and neg.)
Contact interruption	< 1 µs
Result	Test passed

## Ambient conditions

# MCV 1,5/14-GF-3,5 - PCB header



1843347

<https://www.phoenixcontact.com/us/products/1843347>

Ambient temperature (storage/transport)	-40 °C ... 70 °C
Relative humidity (storage/transport)	30 % ... 70 %
Ambient temperature (assembly)	-5 °C ... 100 °C
Ambient temperature (operation)	-40 °C ... 105 °C (dependent on the derating curve)

## Packaging specifications

Type of packaging	packed in cardboard
-------------------	---------------------

# MCV 1,5/14-GF-3,5 - PCB header

1843347

<https://www.phoenixcontact.com/us/products/1843347>

## Drawings

Dimensional drawing

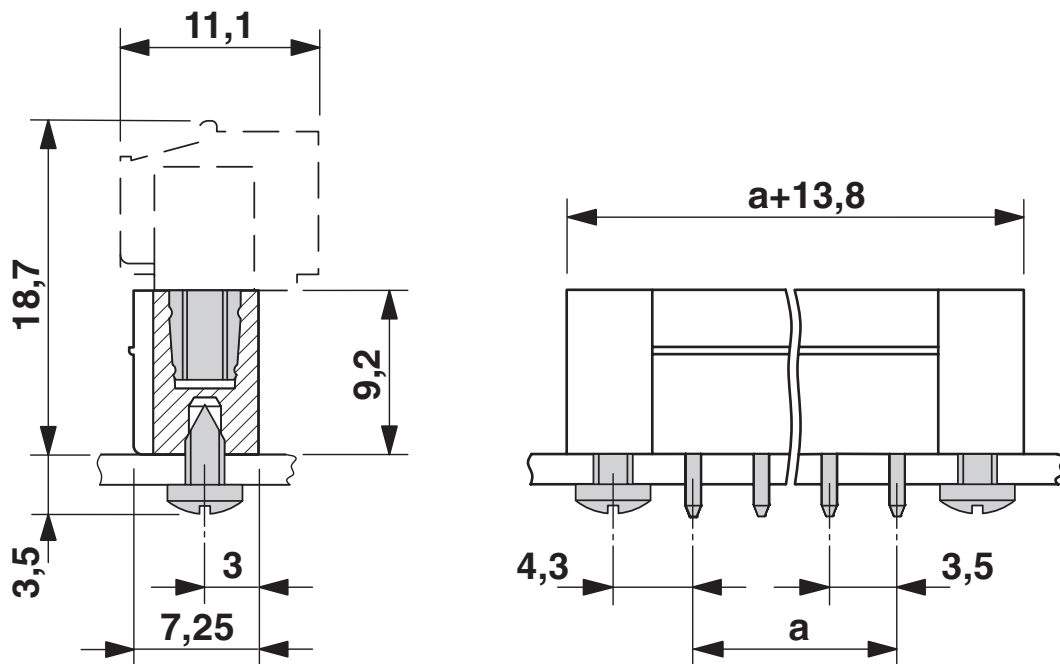

Diagram

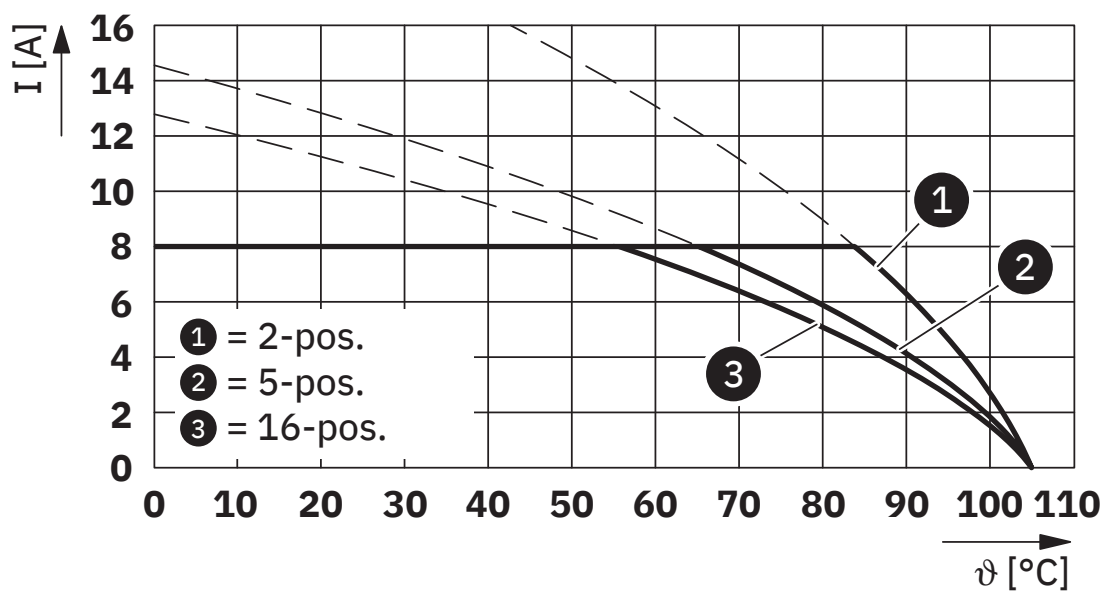

Type: FMCOR 1,5/...-STF-3,5 with MCV 1,5/...-GF-3,5

# MCV 1,5/14-GF-3,5 - PCB header



1843347

<https://www.phoenixcontact.com/us/products/1843347>

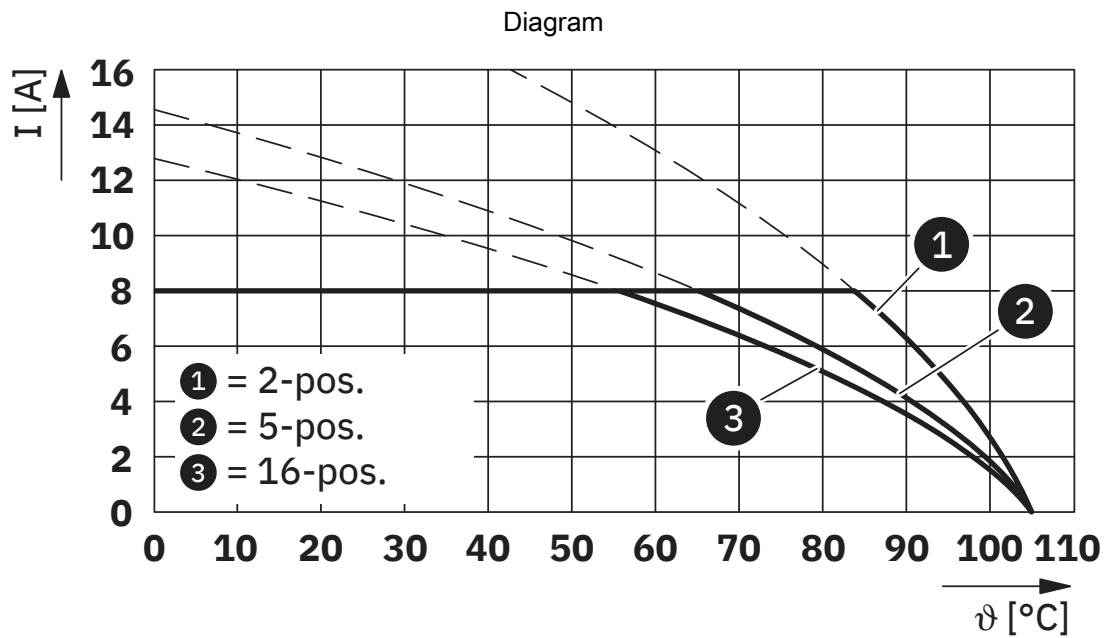

Type: FMCOW 1,5/...-STF-3,5 with MCV 1,5/...-GF-3,5

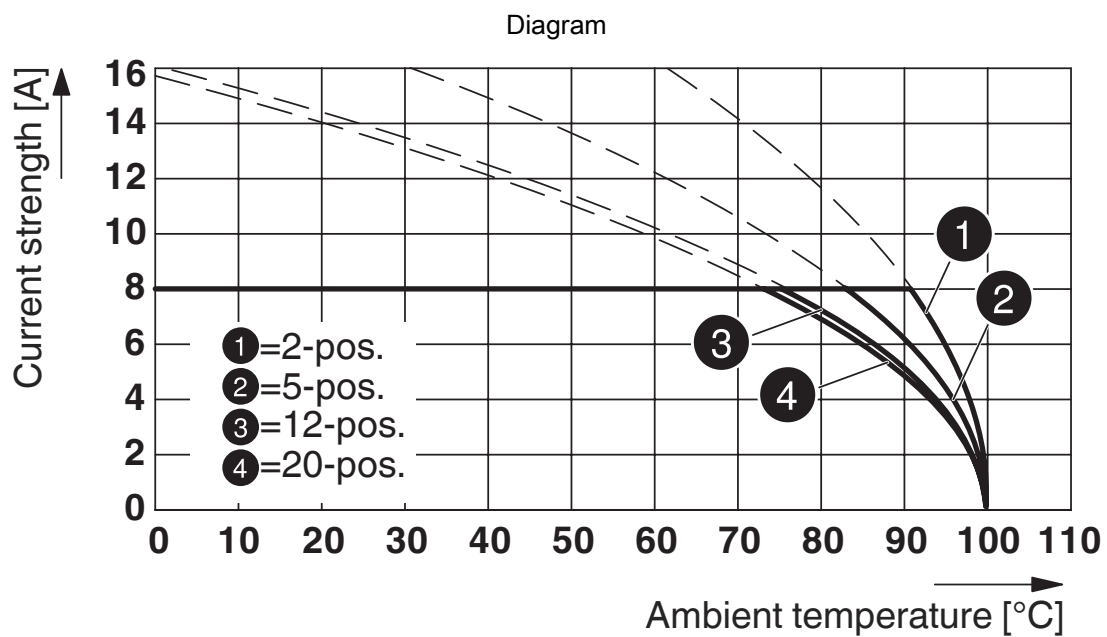

Type: MC 1,5/...-STF-3,5 with MCV 1,5/...-GF-3,5

# MCV 1,5/14-GF-3,5 - PCB header



1843347

<https://www.phoenixcontact.com/us/products/1843347>



Type: FMC 1,5/...-STF-3,5 with MCV 1,5/...-GF-3,5



Type: FK-MCP 1,5/...-STF-3,5 with MCV 1,5/...-GF-3,5

# MCV 1,5/14-GF-3,5 - PCB header



1843347

<https://www.phoenixcontact.com/us/products/1843347>



Type: MCVR 1,5/...-STF-3,5 with MCV 1,5/...-GF-3,5



Type: MCVW 1,5/...-STF-3,5 with MCV 1,5/...-GF-3,5

# MCV 1,5/14-GF-3,5 - PCB header



1843347

<https://www.phoenixcontact.com/us/products/1843347>

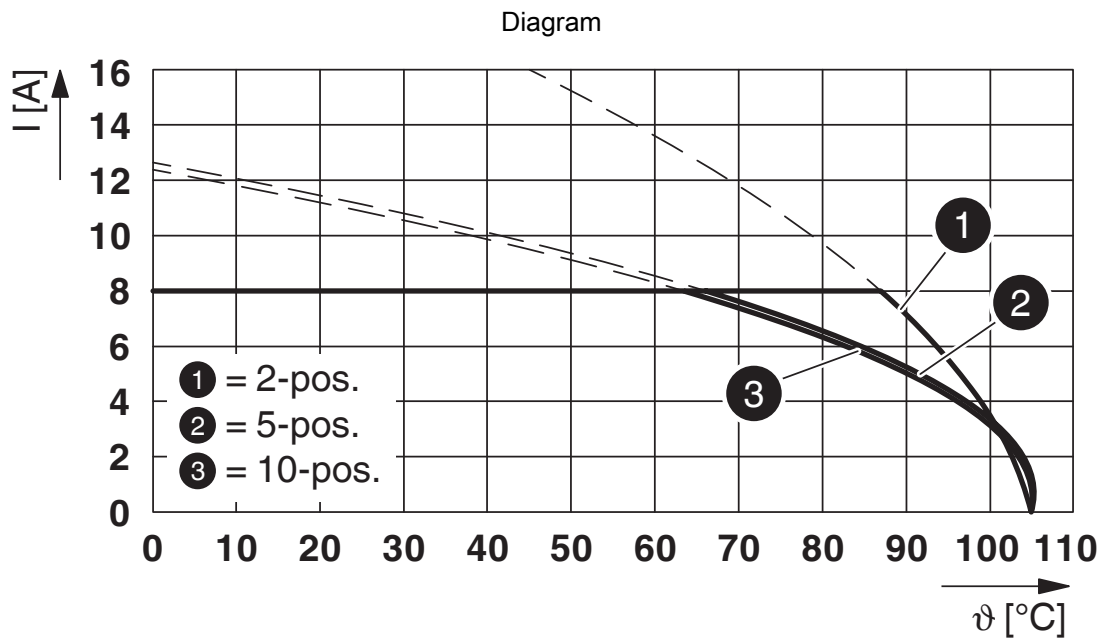

Type: TFMC 1,5/...-STF-3,5 with MCV 1,5/...-GF-3,5



Type: XPC 1,5/...-STF-3,5 with MCV 1,5/...-GF-3,5

# MCV 1,5/14-GF-3,5 - PCB header

1843347

<https://www.phoenixcontact.com/us/products/1843347>



Drilling plan/solder pad geometry

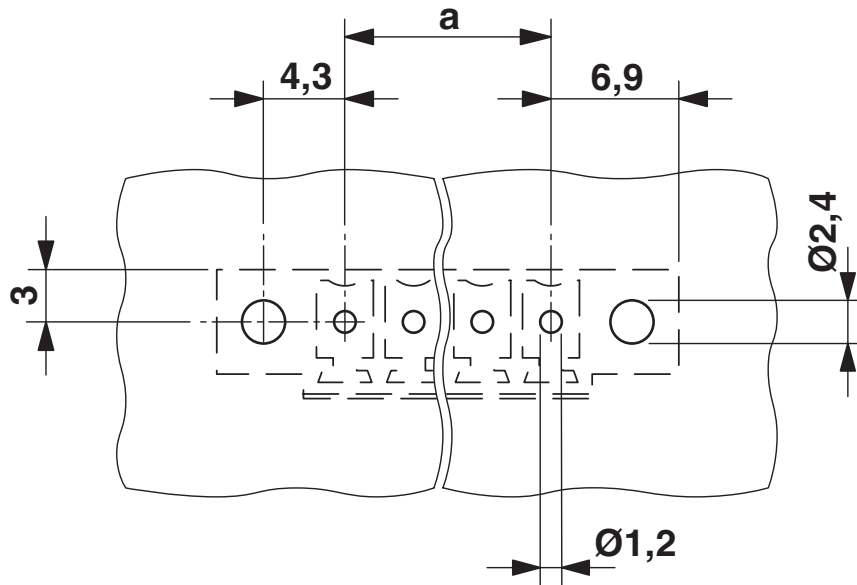

# MCV 1,5/14-GF-3,5 - PCB header



1843347

<https://www.phoenixcontact.com/us/products/1843347>

## Approvals

To download certificates, visit the product detail page: <https://www.phoenixcontact.com/us/products/1843347>

 <b>VDE Zeichengenehmigung</b> Approval ID: 40057836				
	Nominal voltage $U_N$	Nominal current $I_N$	Cross section AWG	Cross section $mm^2$
keine				
	160 V	8 A	-	-

 <b>CSA</b> Approval ID: 13631				
	Nominal voltage $U_N$	Nominal current $I_N$	Cross section AWG	Cross section $mm^2$
B				
	300 V	8 A	-	-
D				
	300 V	8 A	-	-

 <b>cULus Recognized</b> Approval ID: E60425-20110128				
	Nominal voltage $U_N$	Nominal current $I_N$	Cross section AWG	Cross section $mm^2$
B				
	300 V	8 A	-	-
D				
	300 V	8 A	-	-

 <b>VDE Zeichengenehmigung</b> Approval ID: 40011723				
	Nominal voltage $U_N$	Nominal current $I_N$	Cross section AWG	Cross section $mm^2$
keine				
	160 V	8 A	-	-

# MCV 1,5/14-GF-3,5 - PCB header



1843347

<https://www.phoenixcontact.com/us/products/1843347>

## Classifications

### ECLASS

ECLASS-13.0	27460201
ECLASS-15.0	27460201

### ETIM

ETIM 10.0	EC002637
-----------	----------

### UNSPSC

UNSPSC 21.0	39121400
-------------	----------

# MCV 1,5/14-GF-3,5 - PCB header



1843347

<https://www.phoenixcontact.com/us/products/1843347>

## Environmental product compliance

### EU RoHS

Fulfills EU RoHS substance requirements	Yes, No exemptions
---	--------------------

### China RoHS

Environment friendly use period (EFUP)	EFUP-E
	No hazardous substances above the limits

### EU REACH SVHC

REACH candidate substance (CAS No.)	No substance above 0.1 wt%
-------------------------------------	----------------------------

### EF3.1 Climate Change

CO2e kg	0.026 kg CO2e
---------	---------------

Phoenix Contact 2026 © - all rights reserved  
<https://www.phoenixcontact.com>

Phoenix Contact USA  
586 Fulling Mill Road  
Middletown, PA 17057, United States  
(+717) 944-1300  
[info@phoenixcon.com](mailto:info@phoenixcon.com)