

# PSC 1,5/ 5-F - PCB connector

1841912

<https://www.phoenixcontact.com/us/products/1841912>

Please be informed that the data shown in this PDF document is generated from our online catalog. Please find the complete data in the user documentation. Our general terms of use for downloads are valid.



PCB connector, nominal cross section: 1.5 mm<sup>2</sup>, color: green, nominal current: 8 A, rated voltage (III/2): 320 V, contact surface: Sn, contact connection type: Socket, number of potentials: 5, number of rows: 1, number of positions: 5, number of connections: 5, product range: PSC 1,5/-F, pitch: 3.5 mm, connection method: Screw connection with tension sleeve, screw head form: L Slotted, conductor/PCB connection direction: 0 °, plug-in system: PSC 1,5, Electrical properties: shielded, locking: Screw locking mechanism, mounting method: Screw flange, type of packaging: packed in cardboard

## Your advantages

- Well-known mounting principle allows worldwide use
- Low temperature rise, thanks to maximum contact force
- Shroud for professional EMC shield feed-through on the inside of the device
- Screwable flange for superior mechanical stability

## Commercial data

Item number	1841912
Packing unit	50 pc
Minimum order quantity	50 pc
Sales key	AA02
Product key	AABWPA
GTIN	4017918111885
Weight per piece (including packing)	7.34 g
Weight per piece (excluding packing)	6.98 g
Customs tariff number	85366990
Country of origin	PL

# PSC 1,5/ 5-F - PCB connector



1841912

<https://www.phoenixcontact.com/us/products/1841912>

## Technical data

### Product properties

Product type	PCB connector
Product family	PSC 1,5/...-F
Product line	COMBICON Connectors S
Type	Plugs with shielded housing
Number of positions	5
Pitch	3.5 mm
Number of connections	5
Number of rows	1
Number of potentials	5
Mounting type	without
Electrical characteristic	shielded

### Electrical properties

#### Properties

Nominal current $I_N$	8 A
Nominal voltage $U_N$	320 V (for applications in metal or metal-plated housings, the degree of protection "safety extra-low voltage" must be used.)
Rated voltage (III/3)	250 V
Rated surge voltage (III/3)	4 kV
Rated voltage (III/2)	320 V
Rated surge voltage (III/2)	4 kV
Rated voltage (II/2)	630 V
Rated surge voltage (II/2)	4 kV
Electrical characteristic	shielded

### Connection data

#### Connection technology

Type	Plugs with shielded housing
Connector system	PSC 1,5
Nominal cross section	1.5 mm <sup>2</sup>
Contact connection type	Socket

#### Interlock

Locking type	Screw locking mechanism
Mounting type	Screw flange

#### Conductor connection

Connection method	Screw connection with tension sleeve
Conductor/PCB connection direction	0 °
Conductor cross-section rigid	0.14 mm <sup>2</sup> ... 1.5 mm <sup>2</sup>
Conductor cross-section flexible	0.14 mm <sup>2</sup> ... 1.5 mm <sup>2</sup>

# PSC 1,5/ 5-F - PCB connector

1841912

<https://www.phoenixcontact.com/us/products/1841912>

Conductor cross-section AWG	28 ... 16
Conductor cross-section, flexible, with ferrule, without plastic sleeve	0.25 mm <sup>2</sup> ... 1.5 mm <sup>2</sup>
Conductor cross-section, flexible, with ferrule, with plastic sleeve	0.25 mm <sup>2</sup> ... 0.5 mm <sup>2</sup>
Stripping length	7 mm
Drive form screw head	Slotted (L)
Tightening torque	0.22 Nm ... 0.25 Nm

## Specifications for ferrules without insulating collar

recommended crimping tool	1212034 CRIMPFOX 6
---------------------------	--------------------

## Specifications for ferrules with insulating collar

recommended crimping tool	1212034 CRIMPFOX 6
---------------------------	--------------------

## Material specifications

### Material data - contact

Note	WEEE/RoHS-compliant, free of whiskers according to IEC 60068-2-82/JEDEC JESD 201
Contact material	Cu alloy
Metal surface terminal point (top layer)	Tin (5 µm - 7 µm Sn)
Metal surface contact area (top layer)	Tin (5 µm - 7 µm Sn)

### Material data - housing

Color (Housing)	green (6021)
Insulating material	PA
Insulating material group	I
CTI according to IEC 60112	600
Flammability rating according to UL 94	V0
Glow wire flammability index GWFI according to EN 60695-2-12	850
Glow wire ignition temperature GWIT according to EN 60695-2-13	775
Temperature for the ball pressure test according to EN 60695-10-2	125 °C

## Dimensions

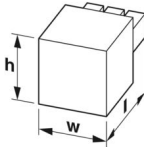
Dimensional drawing	
Pitch	3.5 mm
Width [w]	39.2 mm
Height [h]	12.5 mm
Length [l]	16 mm

## Environmental and real-life conditions

# PSC 1,5/ 5-F - PCB connector



1841912

<https://www.phoenixcontact.com/us/products/1841912>

## Ambient conditions

Relative humidity (storage/transport)	30 % ... 70 %
---------------------------------------	---------------

## Electrical tests

### Air clearances and creepage distances |

Insulating material group	I
Rated insulation voltage (III/3)	250 V
Rated surge voltage (III/3)	4 kV
Rated insulation voltage (III/2)	320 V
Rated surge voltage (III/2)	4 kV
Rated insulation voltage (II/2)	630 V
Rated surge voltage (II/2)	4 kV

## Packaging specifications

Type of packaging	packed in cardboard
-------------------	---------------------

# PSC 1,5/ 5-F - PCB connector

1841912

<https://www.phoenixcontact.com/us/products/1841912>



## Drawings

Dimensional drawing

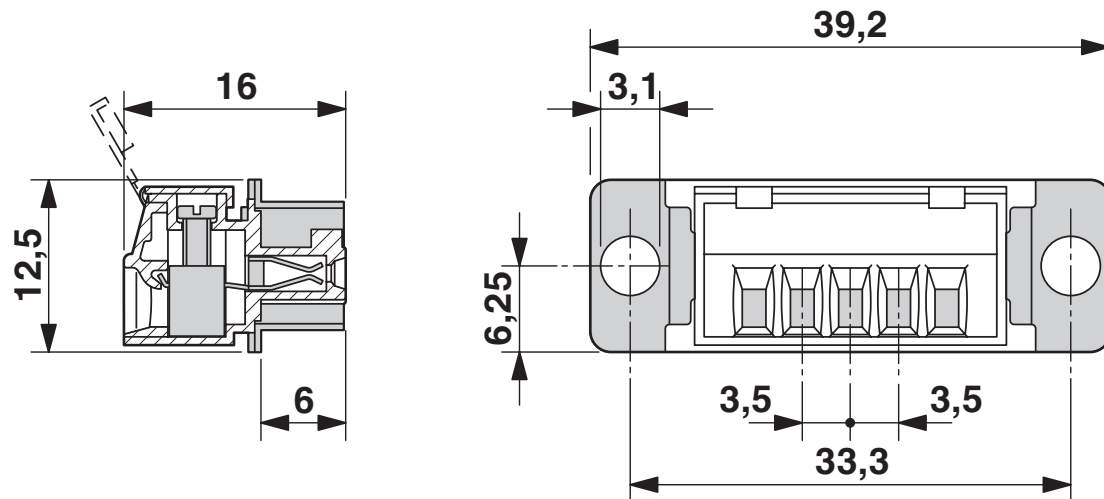

# PSC 1,5/ 5-F - PCB connector





1841912

<https://www.phoenixcontact.com/us/products/1841912>

## Approvals

To download certificates, visit the product detail page: <https://www.phoenixcontact.com/us/products/1841912>

 <b>CSA</b> Approval ID: 13631				
	Nominal voltage $U_N$	Nominal current $I_N$	Cross section AWG	Cross section $\text{mm}^2$
B	300 V	8 A	28 - 16	-
D	300 V	8 A	28 - 16	-

 <b>cULus Recognized</b> Approval ID: E60425-19920306				
	Nominal voltage $U_N$	Nominal current $I_N$	Cross section AWG	Cross section $\text{mm}^2$
B	300 V	8 A	30 - 14	-
D	300 V	8 A	30 - 14	-

# PSC 1,5/ 5-F - PCB connector



1841912

<https://www.phoenixcontact.com/us/products/1841912>

## Classifications

### ECLASS

ECLASS-13.0	27460202
ECLASS-15.0	27460202

### ETIM

ETIM 10.0	EC002638
-----------	----------

### UNSPSC

UNSPSC 21.0	39121400
-------------	----------

# PSC 1,5/ 5-F - PCB connector



1841912

<https://www.phoenixcontact.com/us/products/1841912>

## Environmental product compliance

### EU RoHS

Fulfills EU RoHS substance requirements	Yes, No exemptions
---	--------------------

### China RoHS

Environment friendly use period (EFUP)	EFUP-E
	No hazardous substances above the limits

### EU REACH SVHC

REACH candidate substance (CAS No.)	No substance above 0.1 wt%
-------------------------------------	----------------------------

### EF3.1 Climate Change

CO2e kg	0.078 kg CO2e
---------	---------------

Phoenix Contact 2026 © - all rights reserved  
<https://www.phoenixcontact.com>

Phoenix Contact USA  
586 Fulling Mill Road  
Middletown, PA 17057, United States  
(+717) 944-1300  
[info@phoenixcon.com](mailto:info@phoenixcon.com)