

PCC 4/ 8-ST-7,62 - PCB connector



1840133

<https://www.phoenixcontact.com/us/products/1840133>

Please be informed that the data shown in this PDF document is generated from our online catalog. Please find the complete data in the user documentation. Our general terms of use for downloads are valid.

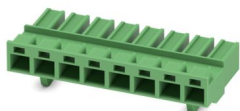

PCB connector, nominal cross section: 4 mm², color: green, nominal current: 20 A, rated voltage (III/2): 1000 V, contact connection type: Socket, number of potentials: 8, number of rows: 1, number of positions: 8, number of connections: 8, product range: PCC 4/..-ST, pitch: 7.62 mm, connection method: Crimp connection, conductor/PCB connection direction: 0 °, locking clip: - Locking clip, plug-in system: COMBICON PC 4, locking: without, mounting method: without, type of packaging: packed in cardboard, Corresponding female crimp contacts with current [A] and conductor cross-section range [mm²] data: 13,5A/STG-MTN 0,5-1,0 (3190438); 13,5A/STG-MTN 0,5-1,0 BA (3190629); 20A/STG-MTN 1,5-2,5 (3190506); 20A/STG-MTN 1,5-2,5 BA (3190632). BA = Taped contacts

Your advantages

- Inexpensive connection of large quantities of preassembled conductors
- Small component size for applications where space is at a premium

Commercial data

Item number	1840133
Packing unit	50 pc
Minimum order quantity	50 pc
Note	Made to order (non-returnable)
Sales key	AA04
Product key	AADCAA
GTIN	4017918102210
Weight per piece (including packing)	8.63 g
Weight per piece (excluding packing)	7.517 g
Customs tariff number	85366990
Country of origin	DE

PCC 4/ 8-ST-7,62 - PCB connector



1840133

<https://www.phoenixcontact.com/us/products/1840133>

Technical data

Product properties

Product type	PCB connector
Product family	PCC 4/..-ST
Product line	COMBICON Connectors L
Type	Standard
Number of positions	8
Pitch	7.62 mm
Number of connections	8
Number of rows	1
Number of potentials	8
Mounting type	without

Electrical properties

Properties

Nominal current I_N	20 A
Nominal voltage U_N	1000 V
Rated voltage (III/3)	400 V
Rated surge voltage (III/3)	8 kV
Rated voltage (III/2)	1000 V
Rated surge voltage (III/2)	8 kV
Rated voltage (II/2)	1000 V
Rated surge voltage (II/2)	8 kV

Connection data

Connection technology

Type	Standard
Connector system	COMBICON PC 4
Nominal cross section	4 mm ²
Contact connection type	Socket

Interlock

Locking type	without
Mounting type	without

Conductor connection

Connection method	Crimp connection
Conductor/PCB connection direction	0 °
Conductor cross-section flexible	0.5 mm ² ... 2.5 mm ²
Conductor cross-section AWG	20 ... 14

Material specifications

PCC 4/ 8-ST-7,62 - PCB connector

1840133

<https://www.phoenixcontact.com/us/products/1840133>

Material data - housing

Color (Housing)	green (6021)
Insulating material	PA
Insulating material group	I
CTI according to IEC 60112	600
Flammability rating according to UL 94	V0
Glow wire flammability index GWFI according to EN 60695-2-12	850
Glow wire ignition temperature GWIT according to EN 60695-2-13	775
Temperature for the ball pressure test according to EN 60695-10-2	125 °C

Dimensions

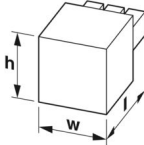
Dimensional drawing	
Pitch	7.62 mm
Width [w]	60.91 mm
Height [h]	17.2 mm
Length [l]	28.7 mm

Notes

Notes on operation	In accordance with IEC 61984, COMBICON connectors have no switching power (COC). During designated use, they must not be plugged in or disconnected when carrying voltage or under load.
--------------------	--

Environmental and real-life conditions

Ambient conditions

Relative humidity (storage/transport)	30 % ... 70 %
---------------------------------------	---------------

Electrical tests

Air clearances and creepage distances |

Insulating material group	I
Rated insulation voltage (III/3)	400 V
Rated surge voltage (III/3)	8 kV
Rated insulation voltage (III/2)	1000 V
Rated surge voltage (III/2)	8 kV
Rated insulation voltage (II/2)	1000 V
Rated surge voltage (II/2)	8 kV

Packaging specifications

Type of packaging	packed in cardboard
-------------------	---------------------

PCC 4/ 8-ST-7,62 - PCB connector





1840133

<https://www.phoenixcontact.com/us/products/1840133>

Approvals

To download certificates, visit the product detail page: <https://www.phoenixcontact.com/us/products/1840133>

 CSA Approval ID: 13631				
	Nominal voltage U_N	Nominal current I_N	Cross section AWG	Cross section mm^2
B	300 V	10 A	20 - 14	-
C	300 V	10 A	20 - 14	-

 cULus Recognized Approval ID: E60425-19920722				
	Nominal voltage U_N	Nominal current I_N	Cross section AWG	Cross section mm^2
B	600 V	10 A	20 - 14	-
C	600 V	10 A	20 - 14	-

PCC 4/ 8-ST-7,62 - PCB connector



1840133

<https://www.phoenixcontact.com/us/products/1840133>

Classifications

ECLASS

ECLASS-13.0	27460202
ECLASS-15.0	27460202

ETIM

ETIM 10.0	EC002638
-----------	----------

UNSPSC

UNSPSC 21.0	39121400
-------------	----------

PCC 4/ 8-ST-7,62 - PCB connector



1840133

<https://www.phoenixcontact.com/us/products/1840133>

Environmental product compliance

EU RoHS

Fulfills EU RoHS substance requirements	Yes, No exemptions
---	--------------------

China RoHS

Environment friendly use period (EFUP)	EFUP-E
	No hazardous substances above the limits

EU REACH SVHC

REACH candidate substance (CAS No.)	No substance above 0.1 wt%
-------------------------------------	----------------------------

EF3.1 Climate Change

CO2e kg	0.052 kg CO2e
---------	---------------

Phoenix Contact 2026 © - all rights reserved
<https://www.phoenixcontact.com>

Phoenix Contact USA
586 Fulling Mill Road
Middletown, PA 17057, United States
(+717) 944-1300
info@phoenixcon.com