

MCV 1,5/ 5-G-5,08 - PCB header



1836325

<https://www.phoenixcontact.com/us/products/1836325>

Please be informed that the data shown in this PDF document is generated from our online catalog. Please find the complete data in the user documentation. Our general terms of use for downloads are valid.

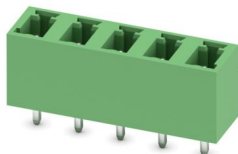

PCB headers, nominal cross section: 1.5 mm², color: green, nominal current: 8 A, rated voltage (III/2): 320 V, contact surface: Sn, contact connection type: Pin, number of potentials: 5, number of rows: 1, number of positions: 5, number of connections: 5, product range: MCV 1,5/..-G, pitch: 5.08 mm, mounting: Wave soldering, pin layout: Linear pinning, solder pin [P]: 3.4 mm, number of solder pins per potential: 1, plug-in system: COMBICON MC 1,5, Pin connector pattern alignment: Standard, locking: without, mounting method: without, type of packaging: packed in cardboard

Your advantages

- Well-known mounting principle allows worldwide use
- Vertical connection enables multi-row arrangement on the PCB
- Maximum flexibility when it comes to device design – one header for connectors with different connection technologies

Commercial data

Item number	1836325
Packing unit	250 pc
Minimum order quantity	50 pc
Sales key	AA02
Product key	AABSCC
GTIN	4017918111182
Weight per piece (including packing)	1.948 g
Weight per piece (excluding packing)	1.91 g
Customs tariff number	85366930
Country of origin	IN

MCV 1,5/ 5-G-5,08 - PCB header



1836325

<https://www.phoenixcontact.com/us/products/1836325>

Technical data

Product properties

Product type	PCB headers
Product family	MCV 1,5/..-G
Product line	COMBICON Connectors S
Type	Standard
Number of positions	5
Pitch	5.08 mm
Number of connections	5
Number of rows	1
Number of potentials	5
Mounting type	without
Pin layout	Linear pinning
Solder pins per potential	1

Electrical properties

Properties

Nominal current I_N	8 A
Nominal voltage U_N	320 V
Contact resistance	1.2 mΩ
Rated voltage (III/3)	250 V
Rated surge voltage (III/3)	4 kV
Rated voltage (III/2)	320 V
Rated surge voltage (III/2)	4 kV
Rated voltage (II/2)	400 V
Rated surge voltage (II/2)	4 kV

Mounting

Mounting type	Wave soldering
Pin layout	Linear pinning

Material specifications

Material data - contact

Note	WEEE/RoHS-compliant, free of whiskers according to IEC 60068-2-82/JEDEC JESD 201
Contact material	Cu alloy
Surface characteristics	Tin-plated
Metal surface contact area (top layer)	Tin (3 μm - 5 μm Sn)
Metal surface contact area (middle layer)	Nickel (1 μm - 3 μm Ni)
Metal surface soldering area (top layer)	Tin (3 μm - 5 μm Sn)
Metal surface soldering area (middle layer)	Nickel (1 μm - 3 μm Ni)

MCV 1,5/ 5-G-5,08 - PCB header



1836325

<https://www.phoenixcontact.com/us/products/1836325>

Material data - housing

Color (Housing)	green (6021)
Insulating material	PBT
Insulating material group	IIIa
CTI according to IEC 60112	225
Flammability rating according to UL 94	V0

Dimensions

Dimensional drawing	
Pitch	5.08 mm
Width [w]	25.4 mm
Height [h]	12.6 mm
Length [l]	7.25 mm
Installed height	10 mm
Solder pin length [P]	3.4 mm
Pin dimensions	0.8 x 0.8 mm

PCB design

Hole diameter	1.2 mm
---------------	--------

Mechanical tests

Visual inspection

Specification	IEC 60512-1-1:2002-02
Result	Test passed

Dimension check

Specification	IEC 60512-1-2:2002-02
Result	Test passed

Resistance of inscriptions

Specification	IEC 60068-2-70:1995-12
Result	Test passed

Polarization and coding

Specification	IEC 60512-13-5:2006-02
Result	Test passed

Contact holder in insert

Specification	IEC 60512-15-1:2008-05
Contact holder in insert Requirements >20 N	Test passed

MCV 1,5/ 5-G-5,08 - PCB header



1836325

<https://www.phoenixcontact.com/us/products/1836325>

Insertion and withdrawal forces

Specification	IEC 60512-13-2:2006-02
Result	Test passed
No. of cycles	25
Insertion strength per pos. approx.	7 N
Withdraw strength per pos. approx.	4 N

Electrical tests

Thermal test | Test group C

Specification	IEC 60512-5-1:2002-02
Tested number of positions	12

Insulation resistance

Specification	IEC 60512-3-1:2002-02
Insulation resistance, neighboring positions	> 5 MΩ

Air clearances and creepage distances |

Specification	IEC 60664-1:2007-04
Insulating material group	IIIa
Comparative tracking index (IEC 60112)	CTI 225
Rated insulation voltage (III/3)	250 V
Rated surge voltage (III/3)	4 kV
minimum clearance value - non-homogenous field (III/3)	3 mm
minimum creepage distance (III/3)	4 mm
Rated insulation voltage (III/2)	320 V
Rated surge voltage (III/2)	4 kV
minimum clearance value - non-homogenous field (III/2)	3 mm
minimum creepage distance (III/2)	3.2 mm
Rated insulation voltage (II/2)	400 V
Rated surge voltage (II/2)	4 kV
minimum clearance value - non-homogenous field (II/2)	3 mm
minimum creepage distance (II/2)	4 mm

Environmental and real-life conditions

Durability test

Specification	IEC 60512-9-1:2010-03
Impulse withstand voltage at sea level	4.8 kV
Contact resistance R ₁	1.2 mΩ
Contact resistance R ₂	1.3 mΩ
Insertion/withdrawal cycles	25
Insulation resistance, neighboring positions	> 5 MΩ

Climatic test

Specification	ISO 6988:1985-02
---------------	------------------

MCV 1,5/ 5-G-5,08 - PCB header



1836325

<https://www.phoenixcontact.com/us/products/1836325>

Corrosive stress	0.2 dm ³ SO ₂ on 300 dm ³ /40 °C/1 cycle
Thermal stress	100 °C/168 h
Power-frequency withstand voltage	2.21 kV

Vibration test

Specification	IEC 60068-2-6:2007-12
Frequency	10 - 150 - 10 Hz
Sweep speed	1 octave/min
Amplitude	0.35 mm (10 Hz ... 60.1 Hz)
Acceleration	5g (60.1 Hz ... 150 Hz)
Test duration per axis	2.5 h
Test directions	X-, Y- and Z-axis

Ambient conditions

Ambient temperature (storage/transport)	-40 °C ... 70 °C
Relative humidity (storage/transport)	30 % ... 70 %
Ambient temperature (assembly)	-5 °C ... 100 °C
Ambient temperature (operation)	-40 °C ... 100 °C (dependent on the derating curve)

Packaging specifications

Type of packaging	packed in cardboard
-------------------	---------------------

MCV 1,5/ 5-G-5,08 - PCB header

1836325

<https://www.phoenixcontact.com/us/products/1836325>

Drawings

Dimensional drawing

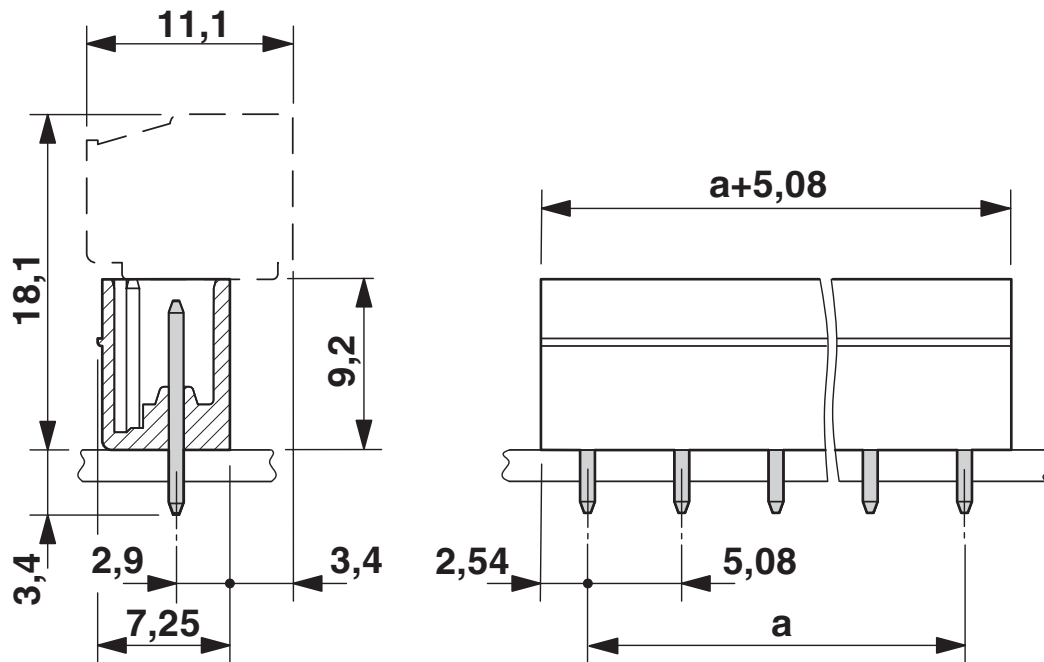

Diagram



Type: MC 1,5/...-ST-5,08 with MCV 1,5/...-G-5,08

MCV 1,5/ 5-G-5,08 - PCB header

1836325

<https://www.phoenixcontact.com/us/products/1836325>

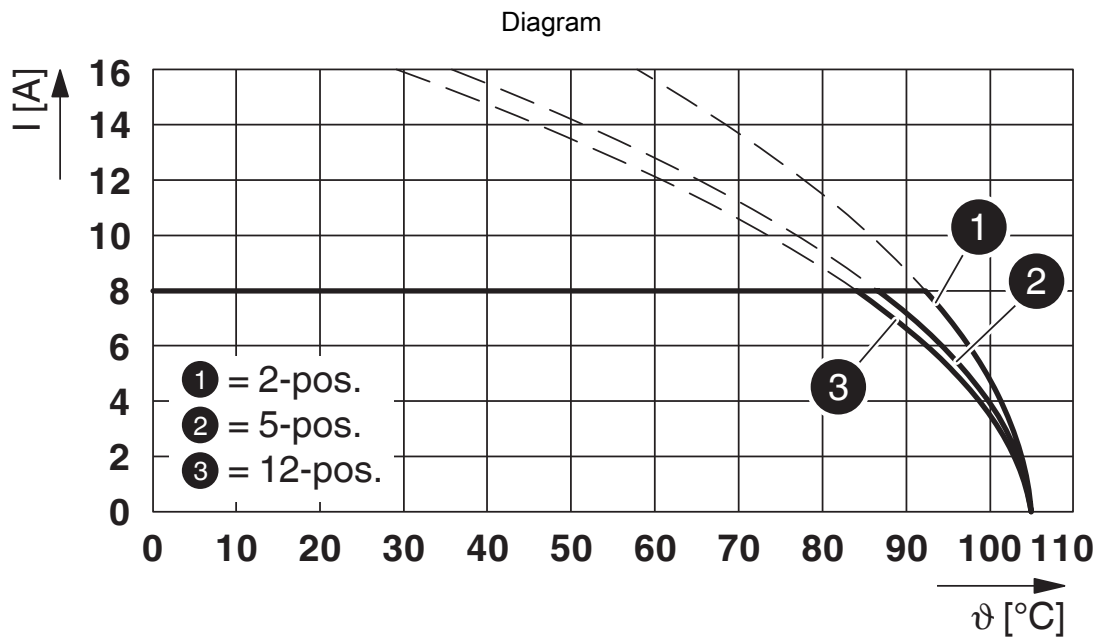

Type: MC 1,5/...-ST1-5,08 with MCV 1,5/...-G-5,08

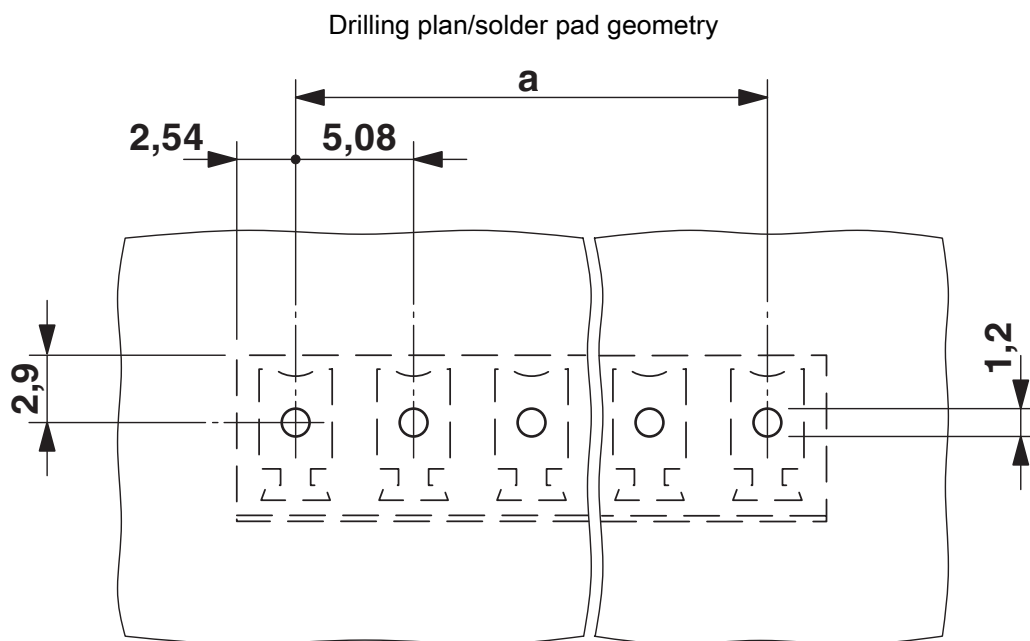

MCV 1,5/ 5-G-5,08 - PCB header



1836325

<https://www.phoenixcontact.com/us/products/1836325>

Approvals

To download certificates, visit the product detail page: <https://www.phoenixcontact.com/us/products/1836325>

 CSA Approval ID: 13631				
	Nominal voltage U_N	Nominal current I_N	Cross section AWG	Cross section mm^2
B	300 V	8 A	-	-
D	300 V	8 A	-	-

 cULus Recognized Approval ID: E60425-20110128				
	Nominal voltage U_N	Nominal current I_N	Cross section AWG	Cross section mm^2
B	300 V	8 A	-	-
D	300 V	8 A	-	-

 VDE Zeichengenehmigung Approval ID: 40011723				
	Nominal voltage U_N	Nominal current I_N	Cross section AWG	Cross section mm^2
keine	250 V	8 A	-	-

MCV 1,5/ 5-G-5,08 - PCB header



1836325

<https://www.phoenixcontact.com/us/products/1836325>

Classifications

ECLASS

ECLASS-13.0	27460201
ECLASS-15.0	27460201

ETIM

ETIM 10.0	EC002637
-----------	----------

UNSPSC

UNSPSC 21.0	39121400
-------------	----------

MCV 1,5/ 5-G-5,08 - PCB header



1836325

<https://www.phoenixcontact.com/us/products/1836325>

Environmental product compliance

EU RoHS

Fulfills EU RoHS substance requirements	Yes, No exemptions
---	--------------------

China RoHS

Environment friendly use period (EFUP)	EFUP-E
	No hazardous substances above the limits

EU REACH SVHC

REACH candidate substance (CAS No.)	No substance above 0.1 wt%
-------------------------------------	----------------------------

Phoenix Contact 2026 © - all rights reserved
<https://www.phoenixcontact.com>

Phoenix Contact USA
586 Fulling Mill Road
Middletown, PA 17057, United States
(+717) 944-1300
info@phoenixcon.com