

# IMCV 1,5/ 7-G-3,5 RN P20 THR - PCB header



1830919

<https://www.phoenixcontact.com/us/products/1830919>

Please be informed that the data shown in this PDF document is generated from our online catalog. Please find the complete data in the user documentation. Our general terms of use for downloads are valid.



PCB headers, nominal cross section: 1.5 mm<sup>2</sup>, color: black, nominal current: 8 A, rated voltage (III/2): 160 V, contact surface: Sn, contact connection type: Socket, number of potentials: 7, number of rows: 1, number of positions: 7, number of connections: 7, product range: IMCV 1,5/-G-RN-THR, pitch: 3.5 mm, mounting: THR soldering / wave soldering, pin layout: Linear pinning, solder pin [P]: 1.9 mm, number of solder pins per potential: 2, plug-in system: COMBICON FMC 1,5 - MCDN 1,5, Pin connector pattern alignment: Standard, locking: Snap-in locking, mounting method: Engagement nose, type of packaging: packed in cardboard

## Your advantages

- Designed for integration into the SMT soldering process
- Intuitive locking mechanism prevents accidental disconnection
- Vertical connection enables multi-row arrangement on the PCB
- Inverted header with socket contacts for touch-proof device outputs or PCB/PCB connections

## Commercial data

Item number	1830919
Packing unit	50 pc
Minimum order quantity	50 pc
Note	Made to order (non-returnable)
Sales key	AA02
Product key	AABTIC
GTIN	4046356888523
Weight per piece (including packing)	2.58 g
Weight per piece (excluding packing)	2.54 g
Customs tariff number	85366930
Country of origin	DE

## Technical data

### Product properties

Product type	PCB headers
Product family	IMCV 1,5/..-G-RN-THR
Product line	COMBICON Connectors S
Type	Inverted
Number of positions	7
Pitch	3.5 mm
Number of connections	7
Number of rows	1
Number of potentials	7
Mounting type	Engagement nose
Pin layout	Linear pinning
Solder pins per potential	2

### Electrical properties

#### Properties

Nominal current $I_N$	8 A
Nominal voltage $U_N$	160 V
Rated voltage (III/3)	160 V
Rated surge voltage (III/3)	2.5 kV
Rated voltage (III/2)	160 V
Rated surge voltage (III/2)	2.5 kV
Rated voltage (II/2)	320 V
Rated surge voltage (II/2)	2.5 kV

### Mounting

Mounting type	THR soldering / wave soldering
Pin layout	Linear pinning

### Material specifications

#### Material data - contact

Note	WEEE/RoHS-compliant, free of whiskers according to IEC 60068-2-82/JEDEC JESD 201
Contact material	Cu alloy
Surface characteristics	hot-dip tin-plated
Metal surface contact area (top layer)	Tin (2 $\mu$ m - 4 $\mu$ m Sn)
Metal surface soldering area (top layer)	Tin (2 $\mu$ m - 4 $\mu$ m Sn)

#### Material data - housing

Color (Housing)	black (9005)
Insulating material	LCP

# IMCV 1,5/ 7-G-3,5 RN P20 THR - PCB header

1830919

<https://www.phoenixcontact.com/us/products/1830919>

Insulating material group	IIIa
CTI according to IEC 60112	175
Flammability rating according to UL 94	V0

## Dimensions

Dimensional drawing	
Pitch	3.5 mm
Width [w]	28.1 mm
Height [h]	16.35 mm
Length [l]	6.3 mm
Installed height	14.45 mm
Solder pin length [P]	1.9 mm
Pin dimensions	0.62 x 1.12 mm

## PCB design

Pin spacing	3.81 mm
Hole diameter	1.2 mm

## Electrical tests

### Air clearances and creepage distances |

Specification	IEC 60664-1:2007-04
Insulating material group	IIIa
Comparative tracking index (IEC 60112)	CTI 175
Rated insulation voltage (III/3)	160 V
Rated surge voltage (III/3)	2.5 kV
minimum clearance value - non-homogenous field (III/3)	1.5 mm
minimum creepage distance (III/3)	2.5 mm
Rated insulation voltage (III/2)	160 V
Rated surge voltage (III/2)	2.5 kV
minimum clearance value - non-homogenous field (III/2)	1.5 mm
minimum creepage distance (III/2)	1.6 mm
Rated insulation voltage (II/2)	320 V
Rated surge voltage (II/2)	2.5 kV
minimum clearance value - non-homogenous field (II/2)	1.5 mm
minimum creepage distance (II/2)	3.2 mm

## Environmental and real-life conditions

### Ambient conditions

Ambient temperature (storage/transport)	-40 °C ... 70 °C
---	------------------

# IMCV 1,5/ 7-G-3,5 RN P20 THR - PCB header



1830919

<https://www.phoenixcontact.com/us/products/1830919>

Relative humidity (storage/transport)	30 % ... 70 %
Ambient temperature (assembly)	-5 °C ... 100 °C
Ambient temperature (operation)	-40 °C ... 100 °C (dependent on the derating curve)

## Packaging specifications

Type of packaging	packed in cardboard
-------------------	---------------------

## Drawings

Dimensional drawing

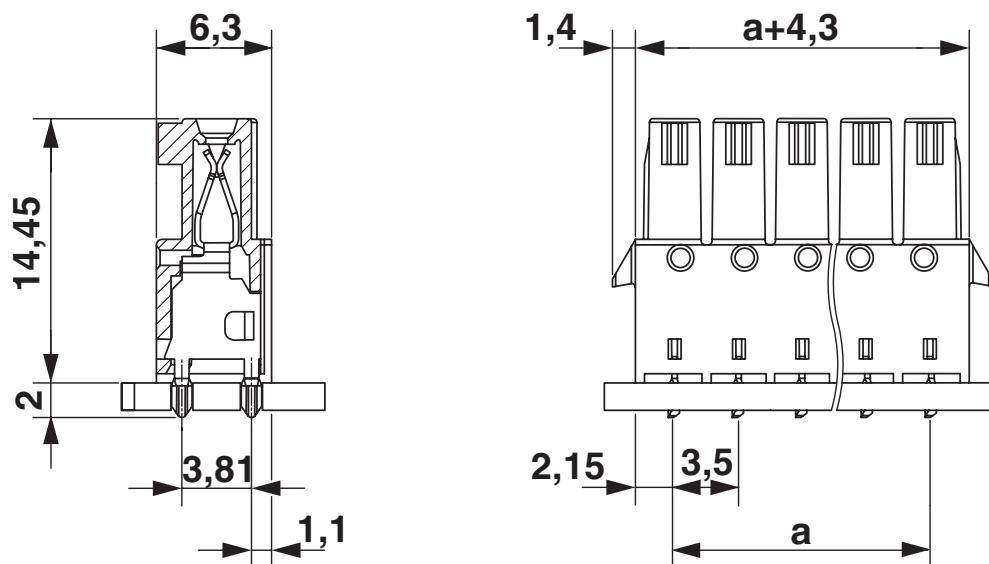

Diagram

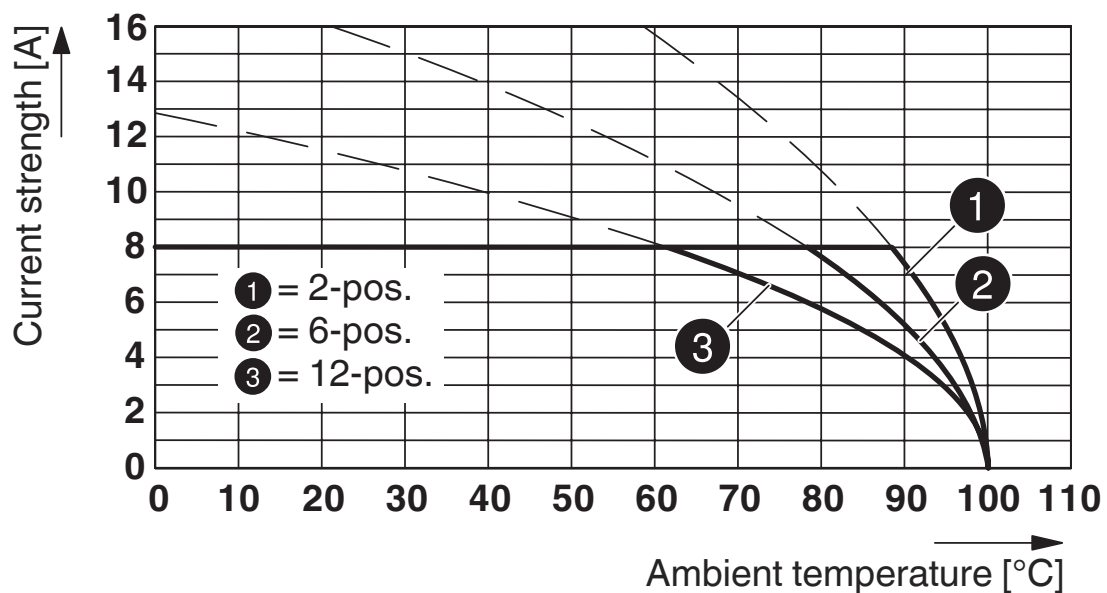

Type: IMC(V) 1,5/...-G-3,5 THR with MC(V) 1,5/...-G-3,5 THR

# IMCV 1,5/ 7-G-3,5 RN P20 THR - PCB header



1830919

<https://www.phoenixcontact.com/us/products/1830919>

Drilling plan/solder pad geometry

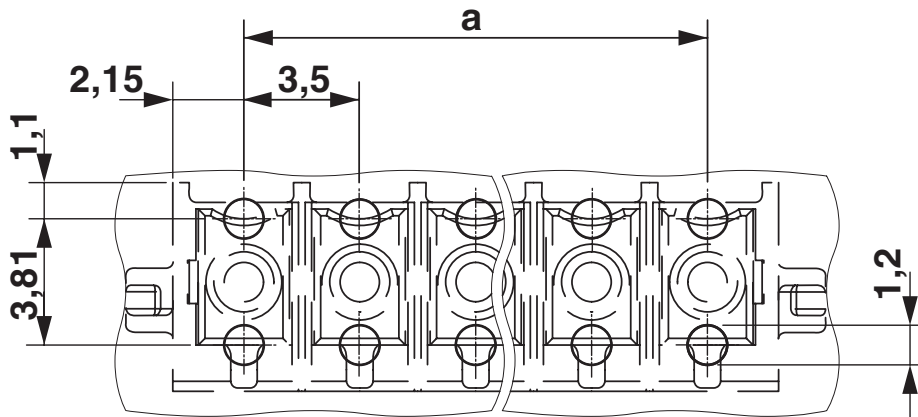

# IMCV 1,5/ 7-G-3,5 RN P20 THR - PCB header



1830919

<https://www.phoenixcontact.com/us/products/1830919>

## Approvals

To download certificates, visit the product detail page: <https://www.phoenixcontact.com/us/products/1830919>

 <b>cULus Recognized</b> Approval ID: E60425-20110128				
	Nominal voltage $U_N$	Nominal current $I_N$	Cross section AWG	Cross section $\text{mm}^2$
B	300 V	8 A	-	-
D	300 V	8 A	-	-

 <b>VDE Zeichengenehmigung</b> Approval ID: 40011723				
	Nominal voltage $U_N$	Nominal current $I_N$	Cross section AWG	Cross section $\text{mm}^2$
keine	160 V	8 A	-	-

# IMCV 1,5/ 7-G-3,5 RN P20 THR - PCB header



1830919

<https://www.phoenixcontact.com/us/products/1830919>

## Classifications

### ECLASS

ECLASS-13.0	27460201
ECLASS-15.0	27460201

### ETIM

ETIM 10.0	EC002637
-----------	----------

### UNSPSC

UNSPSC 21.0	39121400
-------------	----------

1830919

<https://www.phoenixcontact.com/us/products/1830919>

## Environmental product compliance

### EU RoHS

Fulfills EU RoHS substance requirements	Yes, No exemptions
---	--------------------

### China RoHS

Environment friendly use period (EFUP)	EFUP-E
	No hazardous substances above the limits

### EU REACH SVHC

REACH candidate substance (CAS No.)	No substance above 0.1 wt%
-------------------------------------	----------------------------

### EF3.1 Climate Change

CO2e kg	0.033 kg CO2e
---------	---------------

Phoenix Contact 2026 © - all rights reserved  
<https://www.phoenixcontact.com>

Phoenix Contact USA  
586 Fulling Mill Road  
Middletown, PA 17057, United States  
(+717) 944-1300  
[info@phoenixcon.com](mailto:info@phoenixcon.com)