

IMCV 1,5/ 6-G-3,5 RN P20 THR - PCB header



1830906

<https://www.phoenixcontact.com/us/products/1830906>

Please be informed that the data shown in this PDF document is generated from our online catalog. Please find the complete data in the user documentation. Our general terms of use for downloads are valid.



PCB headers, nominal cross section: 1.5 mm², color: black, nominal current: 8 A, rated voltage (III/2): 160 V, contact surface: Sn, contact connection type: Socket, number of potentials: 6, number of rows: 1, number of positions: 6, number of connections: 6, product range: IMCV 1,5/-G-RN-THR, pitch: 3.5 mm, mounting: THR soldering / wave soldering, pin layout: Linear pinning, solder pin [P]: 1.9 mm, number of solder pins per potential: 2, plug-in system: COMBICON FMC 1,5 - MCDN 1,5, Pin connector pattern alignment: Standard, locking: Snap-in locking, mounting method: Engagement nose, type of packaging: packed in cardboard

Your advantages

- Designed for integration into the SMT soldering process
- Intuitive locking mechanism prevents accidental disconnection
- Vertical connection enables multi-row arrangement on the PCB
- Inverted header with socket contacts for touch-proof device outputs or PCB/PCB connections

Commercial data

Item number	1830906
Packing unit	50 pc
Minimum order quantity	50 pc
Note	Made to order (non-returnable)
Sales key	AA02
Product key	AABTIC
GTIN	4046356888516
Weight per piece (including packing)	2.314 g
Weight per piece (excluding packing)	2.3 g
Customs tariff number	85366930
Country of origin	DE

Technical data

Product properties

Product type	PCB headers
Product family	IMCV 1,5/..-G-RN-THR
Product line	COMBICON Connectors S
Type	Inverted
Number of positions	6
Pitch	3.5 mm
Number of connections	6
Number of rows	1
Number of potentials	6
Mounting type	Engagement nose
Pin layout	Linear pinning
Solder pins per potential	2

Electrical properties

Properties

Nominal current I_N	8 A
Nominal voltage U_N	160 V
Rated voltage (III/3)	160 V
Rated surge voltage (III/3)	2.5 kV
Rated voltage (III/2)	160 V
Rated surge voltage (III/2)	2.5 kV
Rated voltage (II/2)	320 V
Rated surge voltage (II/2)	2.5 kV

Mounting

Mounting type	THR soldering / wave soldering
Pin layout	Linear pinning

Material specifications

Material data - contact

Note	WEEE/RoHS-compliant, free of whiskers according to IEC 60068-2-82/JEDEC JESD 201
Contact material	Cu alloy
Surface characteristics	hot-dip tin-plated
Metal surface contact area (top layer)	Tin (2 μ m - 4 μ m Sn)
Metal surface soldering area (top layer)	Tin (2 μ m - 4 μ m Sn)

Material data - housing

Color (Housing)	black (9005)
Insulating material	LCP

IMCV 1,5/ 6-G-3,5 RN P20 THR - PCB header

1830906

<https://www.phoenixcontact.com/us/products/1830906>

Insulating material group	IIIa
CTI according to IEC 60112	175
Flammability rating according to UL 94	V0

Dimensions

Dimensional drawing	
Pitch	3.5 mm
Width [w]	24.6 mm
Height [h]	16.35 mm
Length [l]	6.3 mm
Installed height	14.45 mm
Solder pin length [P]	1.9 mm
Pin dimensions	0.62 x 1.12 mm

PCB design

Pin spacing	3.81 mm
Hole diameter	1.2 mm

Electrical tests

Air clearances and creepage distances |

Specification	IEC 60664-1:2007-04
Insulating material group	IIIa
Comparative tracking index (IEC 60112)	CTI 175
Rated insulation voltage (III/3)	160 V
Rated surge voltage (III/3)	2.5 kV
minimum clearance value - non-homogenous field (III/3)	1.5 mm
minimum creepage distance (III/3)	2.5 mm
Rated insulation voltage (III/2)	160 V
Rated surge voltage (III/2)	2.5 kV
minimum clearance value - non-homogenous field (III/2)	1.5 mm
minimum creepage distance (III/2)	1.6 mm
Rated insulation voltage (II/2)	320 V
Rated surge voltage (II/2)	2.5 kV
minimum clearance value - non-homogenous field (II/2)	1.5 mm
minimum creepage distance (II/2)	3.2 mm

Environmental and real-life conditions

Ambient conditions

Ambient temperature (storage/transport)	-40 °C ... 70 °C
---	------------------

IMCV 1,5/ 6-G-3,5 RN P20 THR - PCB header



1830906

<https://www.phoenixcontact.com/us/products/1830906>

Relative humidity (storage/transport)	30 % ... 70 %
Ambient temperature (assembly)	-5 °C ... 100 °C
Ambient temperature (operation)	-40 °C ... 100 °C (dependent on the derating curve)

Packaging specifications

Type of packaging	packed in cardboard
-------------------	---------------------

Drawings

Dimensional drawing

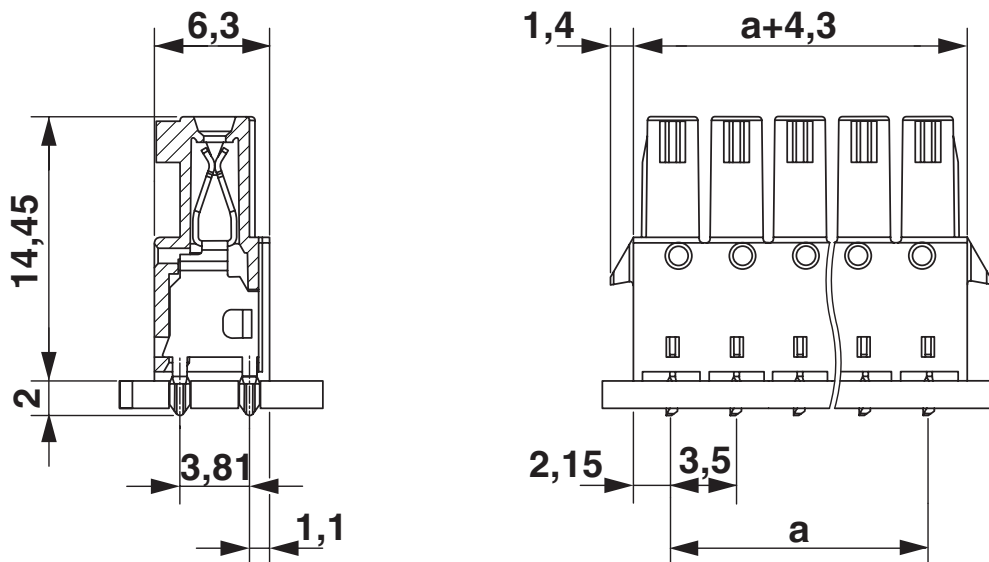

Diagram

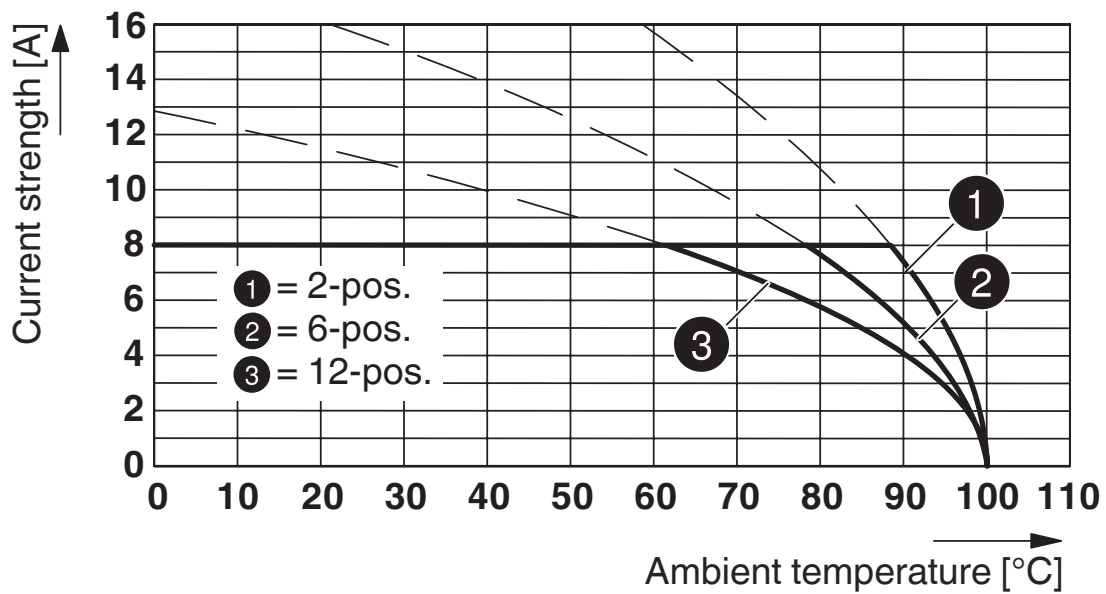

Type: IMC(V) 1,5/...-G-3,5 THR with MC(V) 1,5/...-G-3,5 THR

IMCV 1,5/ 6-G-3,5 RN P20 THR - PCB header



1830906

<https://www.phoenixcontact.com/us/products/1830906>

Drilling plan/solder pad geometry

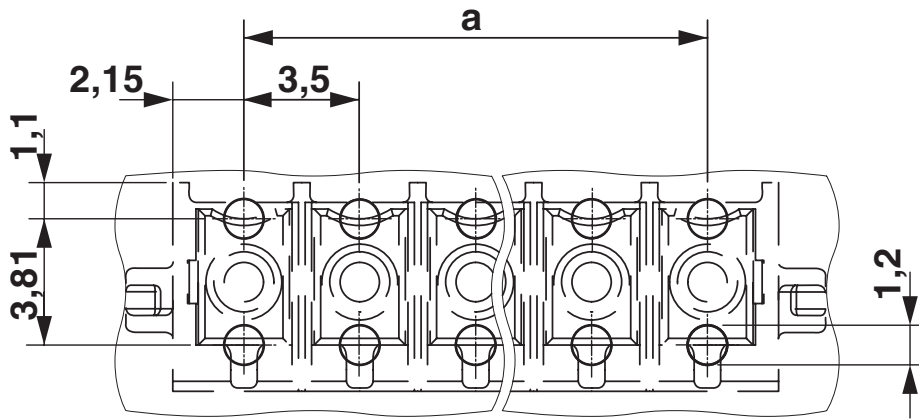

IMCV 1,5/ 6-G-3,5 RN P20 THR - PCB header



1830906

<https://www.phoenixcontact.com/us/products/1830906>

Approvals

To download certificates, visit the product detail page: <https://www.phoenixcontact.com/us/products/1830906>

 cULus Recognized Approval ID: E60425-20110128				
	Nominal voltage U_N	Nominal current I_N	Cross section AWG	Cross section mm^2
B	300 V	8 A	-	-
D	300 V	8 A	-	-

 VDE Zeichengenehmigung Approval ID: 40011723				
	Nominal voltage U_N	Nominal current I_N	Cross section AWG	Cross section mm^2
keine	160 V	8 A	-	-

IMCV 1,5/ 6-G-3,5 RN P20 THR - PCB header



1830906

<https://www.phoenixcontact.com/us/products/1830906>

Classifications

ECLASS

ECLASS-13.0	27460201
ECLASS-15.0	27460201

ETIM

ETIM 10.0	EC002637
-----------	----------

UNSPSC

UNSPSC 21.0	39121400
-------------	----------

IMCV 1,5/ 6-G-3,5 RN P20 THR - PCB header



1830906

<https://www.phoenixcontact.com/us/products/1830906>

Environmental product compliance

EU RoHS

Fulfills EU RoHS substance requirements	Yes, No exemptions
---	--------------------

China RoHS

Environment friendly use period (EFUP)	EFUP-E
	No hazardous substances above the limits

EU REACH SVHC

REACH candidate substance (CAS No.)	No substance above 0.1 wt%
-------------------------------------	----------------------------

EF3.1 Climate Change

CO2e kg	0.043 kg CO2e
---------	---------------

Phoenix Contact 2026 © - all rights reserved
<https://www.phoenixcontact.com>

Phoenix Contact USA
586 Fulling Mill Road
Middletown, PA 17057, United States
(+717) 944-1300
info@phoenixcon.com