

ICC 2,5/17-STZ-5,08 - PCB connector

1823998

<https://www.phoenixcontact.com/us/products/1823998>

Please be informed that the data shown in this PDF document is generated from our online catalog. Please find the complete data in the user documentation. Our general terms of use for downloads are valid.



The figure shows an 10-position version

PCB connector, nominal cross section: 2.5 mm², color: green, nominal current: 12 A, rated voltage (III/2): 320 V, contact connection type: Pin, number of potentials: 17, number of rows: 1, number of positions: 17, number of connections: 17, product range: ICC 2,5/..-STZ, pitch: 5.08 mm, connection method: Crimp connection, conductor/PCB connection direction: 0 °, locking clip: - without locking clip, plug-in system: COMBICON MSTB 2,5, locking: Snap-in locking, mounting method: Engagement nose, type of packaging: packed in cardboard, Corresponding male crimp contacts with current [A] and conductor cross-section range [mm²] data: 10A/ICC-MT 0,5-1,0 (3190577); 10A/ICC-MT 0,5-1,0 BA (3190603); 12A/ICC-MT 1,5-2,5 (3190580); 12A/ICC-MT 1,5-2,5 BA (3190593). BA = Bandkontakte

Your advantages

- Inexpensive connection of large quantities of preassembled conductors
- Pull-out aid facilitates handling and allows the tensile force to be reduced at the contact point
- Can be combined with the MSTB 2,5 range
- Intuitive locking mechanism prevents accidental disconnection

Commercial data

Item number	1823998
Packing unit	50 pc
Minimum order quantity	50 pc
Note	Made to order (non-returnable)
Sales key	AA03
Product key	AACCBA
GTIN	4017918048846
Weight per piece (including packing)	8.2 g
Weight per piece (excluding packing)	7.5 g
Customs tariff number	85389099
Country of origin	PL

ICC 2,5/17-STZ-5,08 - PCB connector



1823998

<https://www.phoenixcontact.com/us/products/1823998>

Technical data

Product properties

Product type	PCB connector
Product family	ICC 2,5/...STZ
Product line	COMBICON Connectors M
Type	Inverted
Number of positions	17
Pitch	5.08 mm
Number of connections	17
Number of rows	1
Number of potentials	17
Mounting type	without

Electrical properties

Properties

Nominal current I_N	12 A
Nominal voltage U_N	320 V
Rated voltage (III/3)	250 V
Rated surge voltage (III/3)	4 kV
Rated voltage (III/2)	320 V
Rated surge voltage (III/2)	4 kV
Rated voltage (II/2)	630 V
Rated surge voltage (II/2)	4 kV

Connection data

Connection technology

Type	Inverted
Connector system	COMBICON MSTB 2,5
Nominal cross section	2.5 mm ²
Contact connection type	Pin

Interlock

Locking type	Snap-in locking
Mounting type	Engagement nose

Conductor connection

Connection method	Crimp connection
Conductor/PCB connection direction	0 °
Conductor cross-section flexible	0.5 mm ² ... 2.5 mm ²
Conductor cross-section AWG	20 ... 14

Material specifications

ICC 2,5/17-STZ-5,08 - PCB connector

1823998

<https://www.phoenixcontact.com/us/products/1823998>

Material data - housing

Color (Housing)	green (6021)
Insulating material	PA
Insulating material group	I
CTI according to IEC 60112	600
Flammability rating according to UL 94	V0
Glow wire flammability index GWFI according to EN 60695-2-12	850
Glow wire ignition temperature GWIT according to EN 60695-2-13	775
Temperature for the ball pressure test according to EN 60695-10-2	125 °C

Dimensions

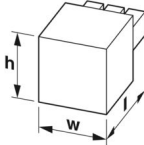
Dimensional drawing	
Pitch	5.08 mm
Width [w]	92.15 mm
Height [h]	10.6 mm
Length [l]	28.1 mm

Notes

Notes on operation	In accordance with IEC 61984, COMBICON connectors have no switching power (COC). During designated use, they must not be plugged in or disconnected when carrying voltage or under load.
--------------------	--

Environmental and real-life conditions

Ambient conditions

Relative humidity (storage/transport)	30 % ... 70 %
---------------------------------------	---------------

Electrical tests

Air clearances and creepage distances |

Insulating material group	I
Rated insulation voltage (III/3)	250 V
Rated surge voltage (III/3)	4 kV
Rated insulation voltage (III/2)	320 V
Rated surge voltage (III/2)	4 kV
Rated insulation voltage (II/2)	630 V
Rated surge voltage (II/2)	4 kV

Packaging specifications

Type of packaging	packed in cardboard
-------------------	---------------------

Drawings

Diagram



Type: ICC 2,5/...-ST-5,08 with IC 2,5/...-G-5,08; contact: ICC-MT 1,5 - 2,5

ICC 2,5/17-STZ-5,08 - PCB connector



1823998

<https://www.phoenixcontact.com/us/products/1823998>

Approvals

To download certificates, visit the product detail page: <https://www.phoenixcontact.com/us/products/1823998>

 cULus Recognized Approval ID: E60425-19930525				
	Nominal voltage U_N	Nominal current I_N	Cross section AWG	Cross section mm^2
B	300 V	10 A	20 - 14	-
D	300 V	10 A	20 - 14	-

 CSA Approval ID: 13631				
	Nominal voltage U_N	Nominal current I_N	Cross section AWG	Cross section mm^2
B	300 V	10 A	20 - 14	-
D	300 V	10 A	20 - 14	-

 VDE approval of drawings Approval ID: 40050648				
--	--	--	--	--

ICC 2,5/17-STZ-5,08 - PCB connector



1823998

<https://www.phoenixcontact.com/us/products/1823998>

Classifications

ECLASS

ECLASS-13.0	27460202
ECLASS-15.0	27460202

ETIM

ETIM 10.0	EC002638
-----------	----------

UNSPSC

UNSPSC 21.0	39121400
-------------	----------

ICC 2,5/17-STZ-5,08 - PCB connector



1823998

<https://www.phoenixcontact.com/us/products/1823998>

Environmental product compliance

EU RoHS

Fulfills EU RoHS substance requirements	Yes, No exemptions
---	--------------------

China RoHS

Environment friendly use period (EFUP)	EFUP-E
	No hazardous substances above the limits

EU REACH SVHC

REACH candidate substance (CAS No.)	No substance above 0.1 wt%
-------------------------------------	----------------------------

EF3.1 Climate Change

CO2e kg	0.078 kg CO2e
---------	---------------

Phoenix Contact 2026 © - all rights reserved
<https://www.phoenixcontact.com>

Phoenix Contact USA
586 Fulling Mill Road
Middletown, PA 17057, United States
(+717) 944-1300
info@phoenixcon.com