

# MCV 0,5/12-G-2,54 SMD R56 - PCB header



1821643

<https://www.phoenixcontact.com/us/products/1821643>

Please be informed that the data shown in this PDF document is generated from our online catalog. Please find the complete data in the user documentation. Our general terms of use for downloads are valid.



PCB headers, nominal cross section: 0.5 mm<sup>2</sup>, color: black, nominal current: 6 A, rated voltage (III/2): 160 V, contact surface: Au, contact connection type: Pin, number of potentials: 12, number of rows: 1, number of positions: 12, number of connections: 12, product range: MCV 0,5/..-G-SMD, pitch: 2.54 mm, mounting: SMD soldering, pin layout: Linear pad geometry, number of solder pins per potential: 1, plug-in system: COMBICON FMC 0,5, Pin connector pattern alignment: Standard, locking: without, mounting method: without, type of packaging: 56 mm wide tape

## Your advantages

- Designed for integration into the SMT soldering process
- Additional solder anchors reduce the mechanical strain on the soldering spots
- Gold-plated contacts ensure transfer quality remains stable over the long term
- Vertical connection enables multi-row arrangement on the PCB
- Supplied in tape-on-reel packing according to IEC 60286-3 for automated mounting

## Commercial data

Item number	1821643
Packing unit	315 pc
Minimum order quantity	315 pc
Note	Made to order (non-returnable)
Sales key	AA01
Product key	AAAUAB
GTIN	4046356789806
Weight per piece (including packing)	3.36 g
Weight per piece (excluding packing)	3.36 g
Customs tariff number	85366930
Country of origin	PL

# MCV 0,5/12-G-2,54 SMD R56 - PCB header



1821643

<https://www.phoenixcontact.com/us/products/1821643>

## Technical data

### Product properties

Product type	PCB headers
Product family	MCV 0,5/..-G-SMD
Product line	COMBICON Connectors XS
Number of positions	12
Pitch	2.54 mm
Number of connections	12
Number of rows	1
Number of potentials	12
Mounting type	without
Pin layout	Linear pad geometry
Solder pins per potential	1

### Electrical properties

#### Properties

Nominal current $I_N$	6 A
Nominal voltage $U_N$	160 V
Contact resistance	2.6 m $\Omega$
Rated voltage (III/3)	32 V
Rated surge voltage (III/3)	2.5 kV
Rated voltage (III/2)	160 V
Rated surge voltage (III/2)	2.5 kV
Rated voltage (II/2)	160 V
Rated surge voltage (II/2)	2.5 kV

### Mounting

Mounting type	SMD soldering
Pin layout	Linear pad geometry

#### Processing notes

Process	Reflow soldering
Moisture Sensitive Level	MSL 1
Classification temperature $T_c$	260 °C
Solder cycles in the reflow	3

### Material specifications

#### Material data - contact

Note	WEEE/RoHS-compliant, free of whiskers according to IEC 60068-2-82/JEDEC JESD 201
Contact material	Cu alloy
Surface characteristics	Completely gold-plated

# MCV 0,5/12-G-2,54 SMD R56 - PCB header



1821643

<https://www.phoenixcontact.com/us/products/1821643>

Metal surface contact area (top layer)	Gold (min. 0.25 µm Au)
Metal surface contact area (middle layer)	Nickel (2 µm - 4 µm Ni)
Metal surface soldering area (top layer)	Gold (0.25 µm Au)
Metal surface soldering area (middle layer)	Nickel (2 µm - 4 µm Ni)

## Material data - housing

Color (Housing)	black (9005)
Insulating material	LCP
Insulating material group	IIIa
CTI according to IEC 60112	175
Flammability rating according to UL 94	V0

## Dimensions

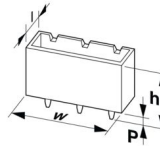
Dimensional drawing	
Pitch	2.54 mm
Width [w]	35.06 mm
Height [h]	7.1 mm
Length [l]	4.85 mm
Pin dimensions	0.64 x 0.64 mm

## PCB design

Pad geometry	1.2 x 2.85 mm
--------------	---------------

## Mechanical tests

### Visual inspection

Specification	IEC 60512-1-1:2002-02
Result	Test passed

### Dimension check

Specification	IEC 60512-1-2:2002-02
Result	Test passed

### Resistance of inscriptions

Specification	IEC 60068-2-70:1995-12
Result	Test passed

### Polarization and coding

Specification	IEC 60512-13-5:2006-02
Result	Test passed

### Contact holder in insert

Specification	IEC 60512-15-1:2008-05
---------------	------------------------

# MCV 0,5/12-G-2,54 SMD R56 - PCB header



1821643

<https://www.phoenixcontact.com/us/products/1821643>

Contact holder in insert Requirements >20 N	Test passed
--	-------------

## Insertion and withdrawal forces

Specification	IEC 60512-13-2:2006-02
Result	Test passed
No. of cycles	100
Insertion strength per pos. approx.	2 N
Withdraw strength per pos. approx.	2 N

## Electrical tests

### Thermal test | Test group C

Specification	IEC 60512-5-1:2002-02
Tested number of positions	16

### Insulation resistance

Specification	IEC 60512-3-1:2002-02
Insulation resistance, neighboring positions	> 5 MΩ

### Air clearances and creepage distances |

Specification	IEC 60664-1:2007-04
Insulating material group	IIIa
Comparative tracking index (IEC 60112)	CTI 175
Rated insulation voltage (III/3)	32 V
Rated surge voltage (III/3)	2.5 kV
minimum clearance value - non-homogenous field (III/3)	1.5 mm
minimum creepage distance (III/3)	1.5 mm
Rated insulation voltage (III/2)	160 V
Rated surge voltage (III/2)	2.5 kV
minimum clearance value - non-homogenous field (III/2)	1.5 mm
minimum creepage distance (III/2)	1.6 mm
Rated insulation voltage (II/2)	160 V
Rated surge voltage (II/2)	2.5 kV
minimum clearance value - non-homogenous field (II/2)	1.5 mm
minimum creepage distance (II/2)	1.6 mm

## Environmental and real-life conditions

### Durability test

Specification	IEC 60512-9-1:2010-03
Impulse withstand voltage at sea level	2.95 kV
Contact resistance R <sub>1</sub>	2.6 mΩ
Contact resistance R <sub>2</sub>	2.6 mΩ
Insertion/withdrawal cycles	100
Insulation resistance, neighboring positions	> 5 MΩ

# MCV 0,5/12-G-2,54 SMD R56 - PCB header



1821643

<https://www.phoenixcontact.com/us/products/1821643>

## Climatic test

Specification	DIN 50018:2013-05
Corrosive stress	1.0 dm <sup>3</sup> SO <sub>2</sub> on 300 dm <sup>3</sup> /40 °C/3 cycles
Thermal stress	100 °C/168 h
Power-frequency withstand voltage	1.39 kV

## Vibration test

Specification	IEC 60068-2-6:2007-12
Frequency	10 - 500 - 10 Hz
Sweep speed	1 octave/min
Amplitude	0.35 mm (10 Hz ... 60.1 Hz)
Acceleration	5g (60.1 Hz ... 500 Hz)
Test duration per axis	2 h
Test directions	X-, Y- and Z-axis (pos. and neg.)

## Ambient conditions

Ambient temperature (storage/transport)	-40 °C ... 70 °C
Relative humidity (storage/transport)	30 % ... 70 %
Ambient temperature (assembly)	-5 °C ... 100 °C
Ambient temperature (operation)	-40 °C ... 100 °C (dependent on the derating curve)

## Packaging specifications

Dimensional drawing	
Type of packaging	56 mm wide tape
[W] tape width	56 mm
[W2] coil overall dimension	≤ 62.4 mm
[A] coil diameter	≤ 330 mm
Outer packaging type	Transparent-Bag

# MCV 0,5/12-G-2,54 SMD R56 - PCB header

1821643

<https://www.phoenixcontact.com/us/products/1821643>

## Drawings

Dimensional drawing



Diagram

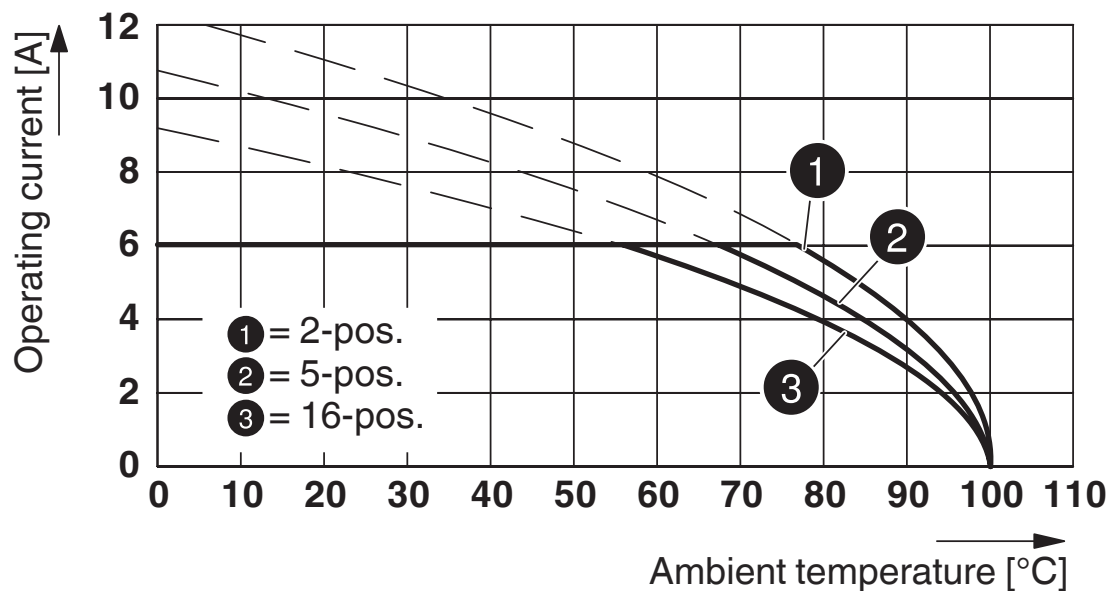

Type FMC 0,5/...-ST-2,54 with MCV 0,5/...-G-2,54 SMD R..

# MCV 0,5/12-G-2,54 SMD R56 - PCB header

1821643

<https://www.phoenixcontact.com/us/products/1821643>



Drilling plan/solder pad geometry

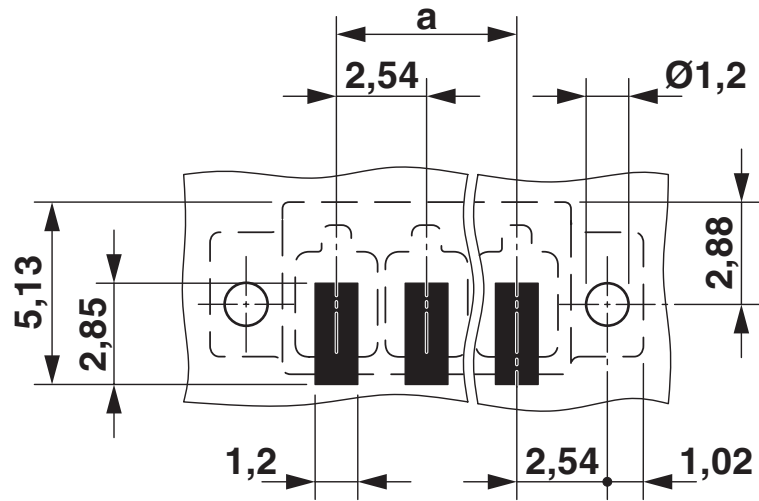

# MCV 0,5/12-G-2,54 SMD R56 - PCB header





1821643

<https://www.phoenixcontact.com/us/products/1821643>

## Approvals

To download certificates, visit the product detail page: <https://www.phoenixcontact.com/us/products/1821643>

 <b>cULus Recognized</b> Approval ID: E60425-19920306				
	Nominal voltage $U_N$	Nominal current $I_N$	Cross section AWG	Cross section $\text{mm}^2$
<b>B</b>				
Field wiring	150 V	6 A	-	-
<b>C</b>				
Factory wiring	50 V	6 A	-	-

 <b>VDE report with production monitoring</b> Approval ID: 40042258				
	Nominal voltage $U_N$	Nominal current $I_N$	Cross section AWG	Cross section $\text{mm}^2$
keine				
	160 V	6 A	-	-

# MCV 0,5/12-G-2,54 SMD R56 - PCB header



1821643

<https://www.phoenixcontact.com/us/products/1821643>

## Classifications

### ECLASS

ECLASS-13.0	27460201
ECLASS-15.0	27460201

### ETIM

ETIM 10.0	EC002637
-----------	----------

### UNSPSC

UNSPSC 21.0	39121400
-------------	----------

# MCV 0,5/12-G-2,54 SMD R56 - PCB header



1821643

<https://www.phoenixcontact.com/us/products/1821643>

## Environmental product compliance

### EU RoHS

Fulfills EU RoHS substance requirements	Yes, No exemptions
---	--------------------

### China RoHS

Environment friendly use period (EFUP)	EFUP-E
	No hazardous substances above the limits

### EU REACH SVHC

REACH candidate substance (CAS No.)	No substance above 0.1 wt%
-------------------------------------	----------------------------

### EF3.1 Climate Change

CO2e kg	0.22 kg CO2e
---------	--------------

Phoenix Contact 2026 © - all rights reserved  
<https://www.phoenixcontact.com>

Phoenix Contact USA  
586 Fulling Mill Road  
Middletown, PA 17057, United States  
(+717) 944-1300  
[info@phoenixcon.com](mailto:info@phoenixcon.com)