

FMC 0,5/ 3-ST-2,54 - PCB connector

1821106

<https://www.phoenixcontact.com/us/products/1821106>

Please be informed that the data shown in this PDF document is generated from our online catalog. Please find the complete data in the user documentation. Our general terms of use for downloads are valid.

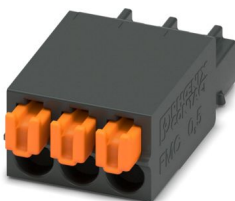

PCB connector, nominal cross section: 0.5 mm², color: black, nominal current: 6 A, rated voltage (III/2): 160 V, contact surface: Au, contact connection type: Socket, number of potentials: 3, number of rows: 1, number of positions: 3, number of connections: 3, product range: FMC 0,5/-ST, pitch: 2.54 mm, connection method: Push-in spring connection, conductor/PCB connection direction: 0 °, plug-in system: COMBICON FMC 0,5, locking: without, mounting method: without, type of packaging: packed in cardboard

Your advantages

- Gold-plated contacts ensure transfer quality remains stable over the long term
- Time saving push-in connection, tools not required
- Defined contact force ensures that contact remains stable over the long term
- Intuitive operation due to color-coded actuating push button
- Optimized for tight installation situations: operation and conductor connection from one direction

Commercial data

Item number	1821106
Packing unit	200 pc
Minimum order quantity	200 pc
Sales key	AA01
Product key	AAAFAA
GTIN	4046356789165
Weight per piece (including packing)	0.82 g
Weight per piece (excluding packing)	0.807 g
Customs tariff number	85366990
Country of origin	PL

FMC 0,5/ 3-ST-2,54 - PCB connector



1821106

<https://www.phoenixcontact.com/us/products/1821106>

Technical data

Product properties

Product type	PCB connector
Product family	FMC 0,5/..-ST
Product line	COMBICON Connectors XS
Type	Standard
Number of positions	3
Pitch	2.54 mm
Number of connections	3
Number of rows	1
Number of potentials	3
Mounting type	without

Electrical properties

Properties

Nominal current I_N	6 A
Nominal voltage U_N	160 V
Contact resistance	2.7 m Ω
Rated voltage (III/3)	32 V
Rated surge voltage (III/3)	0.8 kV
Rated voltage (III/2)	160 V
Rated surge voltage (III/2)	2.5 kV
Rated voltage (II/2)	160 V
Rated surge voltage (II/2)	1.5 kV

Connection data

Connection technology

Type	Standard
Connector system	COMBICON FMC 0,5
Nominal cross section	0.5 mm ²
Contact connection type	Socket

Interlock

Locking type	without
Mounting type	without

Conductor connection

Connection method	Push-in spring connection
Conductor/PCB connection direction	0 °
Conductor cross-section rigid	0.14 mm ² ... 0.5 mm ²
Conductor cross-section flexible	0.14 mm ² ... 0.5 mm ²
Conductor cross-section AWG	26 ... 20

FMC 0,5/ 3-ST-2,54 - PCB connector



1821106

<https://www.phoenixcontact.com/us/products/1821106>

Conductor cross-section, flexible, with ferrule, without plastic sleeve	0.25 mm ² ... 0.34 mm ²
Conductor cross-section, flexible, with ferrule, with plastic sleeve	0.14 mm ² ... 0.25 mm ²
Cylindrical gauge a x b / diameter	- / 1.0 mm
Stripping length	7 mm

Specifications for ferrules without insulating collar

recommended crimping tool	1212034 CRIMPFOX 6
---------------------------	--------------------

Specifications for ferrules with insulating collar

recommended crimping tool	1212034 CRIMPFOX 6
---------------------------	--------------------

Material specifications

Material data - contact

Note	WEEE/RoHS-compliant, free of whiskers according to IEC 60068-2-82/JEDEC JESD 201
Contact material	Cu alloy
Surface characteristics	partially gold-plated
Metal surface terminal point (top layer)	Tin (5 µm - 7 µm Sn)
Metal surface terminal point (middle layer)	Nickel (2 µm - 3 µm Ni)
Metal surface contact area (top layer)	Gold (0.25 µm Au)
Metal surface contact area (middle layer)	Nickel (2 µm - 3 µm Ni)

Material data - housing

Color (Housing)	black (9005)
Insulating material	LCP
Insulating material group	IIIa
CTI according to IEC 60112	175
Flammability rating according to UL 94	V0

Material data – actuating element

Color (Actuating element)	orange (2003)
Insulating material	LCP
Insulating material group	IIIa
CTI according to IEC 60112	175
Flammability rating according to UL 94	V0

Dimensions

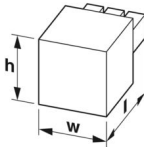
Dimensional drawing	
Pitch	2.54 mm
Width [w]	8.12 mm

FMC 0,5/ 3-ST-2,54 - PCB connector



1821106

<https://www.phoenixcontact.com/us/products/1821106>

Height [h]	5.35 mm
Length [l]	14 mm

Mechanical tests

Conductor connection

Specification	IEC 60999-1:1999-11
Result	Test passed

Test for conductor damage and slackening

Specification	IEC 60999-1:1999-11
Result	Test passed

Repeated connection and disconnection

Specification	IEC 60999-1:1999-11
Result	Test passed

Pull-out test

Specification	IEC 60999-1:1999-11
Conductor cross-section/conductor type/tractive force setpoint/actual value	0.14 mm ² / solid / > 10 N
	0.14 mm ² / flexible / > 10 N
	0.5 mm ² / solid / > 20 N
	0.5 mm ² / flexible / > 20 N

Insertion and withdrawal forces

Specification	IEC 60512-13-2:2006-02
Result	Test passed
No. of cycles	100
Insertion strength per pos. approx.	2 N
Withdraw strength per pos. approx.	2 N

Resistance of inscriptions

Specification	IEC 60068-2-70:1995-12
Result	Test passed

Polarization and coding

Specification	IEC 60512-13-5:2006-02
Result	Test passed

Visual inspection

Specification	IEC 60512-1-1:2002-02
Result	Test passed

Dimension check

Specification	IEC 60512-1-2:2002-02
Result	Test passed

Environmental and real-life conditions

FMC 0,5/ 3-ST-2,54 - PCB connector



1821106

<https://www.phoenixcontact.com/us/products/1821106>

Durability test

Specification	IEC 60512-9-1:2010-03
Impulse withstand voltage at sea level	2.95 kV
Contact resistance R ₁	2.7 mΩ
Contact resistance R ₂	2.6 mΩ
Insertion/withdrawal cycles	100
Insulation resistance, neighboring positions	> 5 MΩ

Climatic test

Specification	DIN 50018:2013-05
Corrosive stress	1.0 dm ³ SO ₂ on 300 dm ³ /40 °C/3 cycles
Thermal stress	100 °C/168 h
Power-frequency withstand voltage	1.39 kV

Vibration test

Specification	IEC 60068-2-6:2007-12
Frequency	10 - 500 - 10 Hz
Sweep speed	1 octave/min
Amplitude	0.35 mm (10 Hz ... 60.1 Hz)
Acceleration	5g (60.1 Hz ... 500 Hz)
Test duration per axis	2 h
Test directions	X-, Y- and Z-axis (pos. and neg.)

Ambient conditions

Ambient temperature (storage/transport)	-40 °C ... 70 °C
Relative humidity (storage/transport)	30 % ... 70 %
Ambient temperature (assembly)	-5 °C ... 100 °C
Ambient temperature (operation)	-40 °C ... 100 °C (dependent on the derating curve)

Electrical tests

Thermal test | Test group C

Specification	IEC 60512-5-1:2002-02
Tested number of positions	16

Insulation resistance

Specification	IEC 60512-3-1:2002-02
Insulation resistance, neighboring positions	> 5 MΩ

Temperature cycles

Specification	IEC 60999-1:1999-11
Result	Test passed

Air clearances and creepage distances |

Specification	IEC 60664-1:2007-04
Insulating material group	IIIa
Comparative tracking index (IEC 60112)	CTI 175

FMC 0,5/ 3-ST-2,54 - PCB connector



1821106

<https://www.phoenixcontact.com/us/products/1821106>

Rated insulation voltage (III/3)	32 V
Rated surge voltage (III/3)	0.8 kV
minimum clearance value - non-homogenous field (III/3)	0.8 mm
minimum creepage distance (III/3)	1.3 mm
Rated insulation voltage (III/2)	160 V
Rated surge voltage (III/2)	2.5 kV
minimum clearance value - non-homogenous field (III/2)	1.5 mm
minimum creepage distance (III/2)	1.6 mm
Rated insulation voltage (II/2)	160 V
Rated surge voltage (II/2)	1.5 kV
minimum clearance value - non-homogenous field (II/2)	0.5 mm
minimum creepage distance (II/2)	1.6 mm

Packaging specifications

Type of packaging	packed in cardboard
Outer packaging type	Carton

Drawings

Diagram



Type: FMC 0,5/...-ST-2,54 with MC 0,5/...-G-2,54 P20 THR R..

Diagram



Type: FMC 0,5/...-ST-2,54 with MC 0,5/...-G-2,54 SMD R..



Type: FMC 0,5/...-ST-2,54 with MCV 0,5/...-G-2,54 P20 THR R..



Type FMC 0,5/...-ST-2,54 with MCV 0,5/...-G-2,54 SMD R..

FMC 0,5/ 3-ST-2,54 - PCB connector



1821106

<https://www.phoenixcontact.com/us/products/1821106>

Approvals

To download certificates, visit the product detail page: <https://www.phoenixcontact.com/us/products/1821106>

 cULus Recognized Approval ID: E60425-19920306				
	Nominal voltage U_N	Nominal current I_N	Cross section AWG	Cross section mm^2
B				
Field wiring	150 V	5 A	26 - 20	-
Factory wiring	150 V	6 A	26 - 20	-
C				
Factory wiring	50 V	6 A	26 - 20	-
F				
Field wiring	160 V	5 A	26 - 20	-

 VDE report with production monitoring Approval ID: 40042258				
	Nominal voltage U_N	Nominal current I_N	Cross section AWG	Cross section mm^2
keine				
	160 V	6 A	-	0.14 - 0.5

FMC 0,5/ 3-ST-2,54 - PCB connector



1821106

<https://www.phoenixcontact.com/us/products/1821106>

Classifications

ECLASS

ECLASS-13.0	27460202
ECLASS-15.0	27460202

ETIM

ETIM 10.0	EC002638
-----------	----------

UNSPSC

UNSPSC 21.0	39121400
-------------	----------

FMC 0,5/ 3-ST-2,54 - PCB connector



1821106

<https://www.phoenixcontact.com/us/products/1821106>

Environmental product compliance

EU RoHS

Fulfills EU RoHS substance requirements	Yes, No exemptions
---	--------------------

China RoHS

Environment friendly use period (EFUP)	EFUP-E
	No hazardous substances above the limits

EU REACH SVHC

REACH candidate substance (CAS No.)	No substance above 0.1 wt%
-------------------------------------	----------------------------

EF3.1 Climate Change

CO2e kg	0.028 kg CO2e
---------	---------------

Phoenix Contact 2026 © - all rights reserved
<https://www.phoenixcontact.com>

Phoenix Contact USA
586 Fulling Mill Road
Middletown, PA 17057, United States
(+717) 944-1300
info@phoenixcon.com