

MSTBC 2,5/ 8-STZFD-5,08 - PCB connector



1809336

<https://www.phoenixcontact.com/us/products/1809336>

Please be informed that the data shown in this PDF document is generated from our online catalog. Please find the complete data in the user documentation. Our general terms of use for downloads are valid.



PCB connector, nominal cross section: 2.5 mm², color: green, nominal current: 12 A, rated voltage (III/2): 320 V, contact connection type: Socket, number of potentials: 8, number of rows: 1, number of positions: 8, number of connections: 8, product range: MSTBC 2,5/..-STZFD, pitch: 5.08 mm, connection method: Crimp connection, mounting: Direct mounting, conductor/PCB connection direction: 0 °, locking clip: - without locking clip, plug-in system: COMBICON MSTB 2,5, locking: Screw locking mechanism, mounting method: Screw flange, type of packaging: packed in cardboard, Corresponding female crimp contacts with current [A] and conductor cross-section range [mm²] data: 10A/MSTBC-MT 0,5-1,0 (3190564); 10A/MSTBC-MT 0,5-1,0 BA (3190645); 12A/MSTBC-MT 1,5-2,5 (3190551); 12A/MSTBC-MT 1,5-2,5 BA (3190658). BA = Bandkontakte

Your advantages

- Inexpensive connection of large quantities of preassembled conductors
- Pull-out aid facilitates handling and allows the tensile force to be reduced at the contact point

Commercial data

| | |
|--------------------------------------|--------------------------------|
| Item number | 1809336 |
| Packing unit | 50 pc |
| Minimum order quantity | 50 pc |
| Note | Made to order (non-returnable) |
| Sales key | AA03 |
| Product key | AACCED |
| GTIN | 4017918047474 |
| Weight per piece (including packing) | 5.358 g |
| Weight per piece (excluding packing) | 4.867 g |
| Customs tariff number | 85389099 |
| Country of origin | PL |

MSTBC 2,5/ 8-STZFD-5,08 - PCB connector



1809336

<https://www.phoenixcontact.com/us/products/1809336>

Technical data

Product properties

| | |
|-----------------------|-----------------------|
| Product type | PCB connector |
| Product family | MSTBC 2,5/...-STZFD |
| Product line | COMBICON Connectors M |
| Type | Direct mounting |
| Number of positions | 8 |
| Pitch | 5.08 mm |
| Number of connections | 8 |
| Number of rows | 1 |
| Number of potentials | 8 |
| Mounting type | Screw flange |

Electrical properties

Properties

| | |
|-----------------------------|-------|
| Nominal current I_N | 12 A |
| Nominal voltage U_N | 320 V |
| Rated voltage (III/3) | 320 V |
| Rated surge voltage (III/3) | 4 kV |
| Rated voltage (III/2) | 320 V |
| Rated surge voltage (III/2) | 4 kV |
| Rated voltage (II/2) | 630 V |
| Rated surge voltage (II/2) | 4 kV |

Connection data

Connection technology

| | |
|-------------------------|---------------------|
| Type | Direct mounting |
| Connector system | COMBICON MSTB 2,5 |
| Nominal cross section | 2.5 mm ² |
| Contact connection type | Socket |

Interlock

| | |
|-------------------|-------------------------|
| Locking type | Screw locking mechanism |
| Mounting type | Screw flange |
| Tightening torque | 0.3 Nm |

Conductor connection

| | |
|------------------------------------|---|
| Connection method | Crimp connection |
| Conductor/PCB connection direction | 0 ° |
| Conductor cross-section flexible | 0.5 mm ² ... 2.5 mm ² |
| Conductor cross-section AWG | 20 ... 14 |

MSTBC 2,5/ 8-STZFD-5,08 - PCB connector

1809336

<https://www.phoenixcontact.com/us/products/1809336>

Material specifications

Material data - housing

| | |
|---|--------------|
| Color (Housing) | green (6021) |
| Insulating material | PA |
| Insulating material group | I |
| CTI according to IEC 60112 | 600 |
| Flammability rating according to UL 94 | V0 |
| Glow wire flammability index GWFI according to EN 60695-2-12 | 850 |
| Glow wire ignition temperature GWIT according to EN 60695-2-13 | 775 |
| Temperature for the ball pressure test according to EN 60695-10-2 | 125 °C |

Dimensions

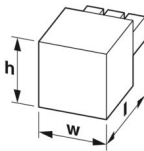
| | |
|---------------------|---|
| Dimensional drawing |  |
| Pitch | 5.08 mm |
| Width [w] | 50.29 mm |
| Height [h] | 10.7 mm |
| Length [l] | 25 mm |

Mounting

| | |
|-------------------|-----------------|
| Mounting type | Direct mounting |
| Tightening torque | 0.3 Nm |

Notes

| | |
|--------------------|--|
| Notes on operation | In accordance with IEC 61984, COMBICON connectors have no switching power (COC). During designated use, they must not be plugged in or disconnected when carrying voltage or under load. |
|--------------------|--|

Environmental and real-life conditions

Ambient conditions

| | |
|---|---|
| Ambient temperature (storage/transport) | -40 °C ... 70 °C |
| Relative humidity (storage/transport) | 30 % ... 70 % |
| Ambient temperature (assembly) | -5 °C ... 100 °C |
| Ambient temperature (operation) | -40 °C ... 100 °C (dependent on the derating curve) |

Electrical tests

Air clearances and creepage distances |

| | |
|---------------|---------------------|
| Specification | IEC 60664-1:2007-04 |
|---------------|---------------------|

MSTBC 2,5/ 8-STZFD-5,08 - PCB connector



1809336

<https://www.phoenixcontact.com/us/products/1809336>

| | |
|--|---------|
| Insulating material group | I |
| Comparative tracking index (IEC 60112) | CTI 600 |
| Rated insulation voltage (III/3) | 320 V |
| Rated surge voltage (III/3) | 4 kV |
| minimum clearance value - non-homogenous field (III/3) | 3 mm |
| minimum creepage distance (III/3) | 4 mm |
| Rated insulation voltage (III/2) | 320 V |
| Rated surge voltage (III/2) | 4 kV |
| minimum clearance value - non-homogenous field (III/2) | 3 mm |
| minimum creepage distance (III/2) | 3 mm |
| Rated insulation voltage (II/2) | 630 V |
| Rated surge voltage (II/2) | 4 kV |
| minimum clearance value - non-homogenous field (II/2) | 3 mm |
| minimum creepage distance (II/2) | 3.2 mm |

Packaging specifications

| | |
|-------------------|---------------------|
| Type of packaging | packed in cardboard |
|-------------------|---------------------|

Drawings

Drilling plan/solder pad geometry



MSTBC 2,5/ 8-STZFD-5,08 - PCB connector



1809336

<https://www.phoenixcontact.com/us/products/1809336>

Approvals

To download certificates, visit the product detail page: <https://www.phoenixcontact.com/us/products/1809336>

|  cULus Recognized Approval ID: E60425-19930525 | | | | |
|---|-----------------------|-----------------------|-------------------|-----------------------------|
| | Nominal voltage U_N | Nominal current I_N | Cross section AWG | Cross section mm^2 |
| B | 300 V | 10 A | 20 - 14 | - |
| D | 300 V | 10 A | 20 - 14 | - |

|  CSA Approval ID: 13631 | | | | |
|--|-----------------------|-----------------------|-------------------|-----------------------------|
| | Nominal voltage U_N | Nominal current I_N | Cross section AWG | Cross section mm^2 |
| keine | 300 V | 10 A | 20 - 14 | - |

|  VDE approval of drawings Approval ID: 40050648 | | | | |
|--|--|--|--|--|
|--|--|--|--|--|

MSTBC 2,5/ 8-STZFD-5,08 - PCB connector



1809336

<https://www.phoenixcontact.com/us/products/1809336>

Classifications

ECLASS

| | |
|-------------|----------|
| ECLASS-13.0 | 27460202 |
| ECLASS-15.0 | 27460202 |

ETIM

| | |
|-----------|----------|
| ETIM 10.0 | EC002638 |
|-----------|----------|

UNSPSC

| | |
|-------------|----------|
| UNSPSC 21.0 | 39121400 |
|-------------|----------|

MSTBC 2,5/ 8-STZFD-5,08 - PCB connector



1809336

<https://www.phoenixcontact.com/us/products/1809336>

Environmental product compliance

EU RoHS

| | |
|---|--------------------|
| Fulfills EU RoHS substance requirements | Yes, No exemptions |
|---|--------------------|

China RoHS

| | |
|--|--|
| Environment friendly use period (EFUP) | EFUP-E |
| | No hazardous substances above the limits |

EU REACH SVHC

| | |
|-------------------------------------|----------------------------|
| REACH candidate substance (CAS No.) | No substance above 0.1 wt% |
|-------------------------------------|----------------------------|

EF3.1 Climate Change

| | |
|---------|---------------|
| CO2e kg | 0.025 kg CO2e |
|---------|---------------|

Phoenix Contact 2026 © - all rights reserved
<https://www.phoenixcontact.com>

Phoenix Contact USA
586 Fulling Mill Road
Middletown, PA 17057, United States
(+717) 944-1300
info@phoenixcon.com