

MSTBC 2,5/ 4-ST-5,08 - PCB connector



1808832

<https://www.phoenixcontact.com/us/products/1808832>

Please be informed that the data shown in this PDF document is generated from our online catalog. Please find the complete data in the user documentation. Our general terms of use for downloads are valid.

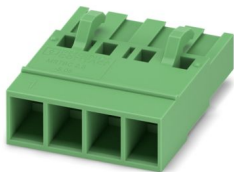

PCB connector, nominal cross section: 2.5 mm², color: green, nominal current: 12 A, rated voltage (III/2): 320 V, contact connection type: Socket, number of potentials: 4, number of rows: 1, number of positions: 4, number of connections: 4, product range: MSTBC 2,5/..-ST, pitch: 5.08 mm, connection method: Crimp connection, conductor/PCB connection direction: 0 °, locking clip: - Locking clip, plug-in system: COMBICON MSTB 2,5, locking: without, mounting method: without, type of packaging: packed in cardboard, Corresponding female crimp contacts with current [A] and conductor cross-section range [mm²] data: 10A/MSTBC-MT 0,5-1,0 (3190564); 10A/MSTBC-MT 0,5-1,0 BA (3190645); 12A/MSTBC-MT 1,5-2,5 (3190551); 12A/MSTBC-MT 1,5-2,5 BA (3190658). BA = Bandkontakte

Your advantages

- Inexpensive connection of large quantities of preassembled conductors

Commercial data

Item number	1808832
Packing unit	50 pc
Minimum order quantity	50 pc
Sales key	AA03
Product key	AACCEA
GTIN	4017918047184
Weight per piece (including packing)	2.16 g
Weight per piece (excluding packing)	1.816 g
Customs tariff number	85389099
Country of origin	PL

MSTBC 2,5/ 4-ST-5,08 - PCB connector



1808832

<https://www.phoenixcontact.com/us/products/1808832>

Technical data

Product properties

Product type	PCB connector
Product family	MSTBC 2,5/..-ST
Product line	COMBICON Connectors M
Type	Standard
Number of positions	4
Pitch	5.08 mm
Number of connections	4
Number of rows	1
Number of potentials	4
Mounting type	without

Electrical properties

Properties

Nominal current I_N	12 A
Nominal voltage U_N	320 V
Rated voltage (III/3)	320 V
Rated surge voltage (III/3)	4 kV
Rated voltage (III/2)	320 V
Rated surge voltage (III/2)	4 kV
Rated voltage (II/2)	630 V
Rated surge voltage (II/2)	4 kV

Connection data

Connection technology

Type	Standard
Connector system	COMBICON MSTB 2,5 COMBICON MSTB 2,5
Nominal cross section	2.5 mm ²
Contact connection type	Socket

Interlock

Locking type	without
Mounting type	without

Conductor connection

Connection method	Crimp connection
Conductor/PCB connection direction	0 °
Conductor cross-section flexible	0.5 mm ² ... 2.5 mm ²
Conductor cross-section AWG	20 ... 14

MSTBC 2,5/ 4-ST-5,08 - PCB connector

1808832

<https://www.phoenixcontact.com/us/products/1808832>

Material specifications

Material data - contact

Metal surface contact area (top layer)	Tin (Sn)
--	----------

Material data - housing

Color (Housing)	green (6021)
Insulating material	PA
Insulating material group	I
CTI according to IEC 60112	600
Flammability rating according to UL 94	V0
Glow wire flammability index GWFI according to EN 60695-2-12	850
Glow wire ignition temperature GWIT according to EN 60695-2-13	775
Temperature for the ball pressure test according to EN 60695-10-2	125 °C

Dimensions

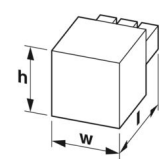
Dimensional drawing	
Pitch	5.08 mm
Width [w]	20.32 mm
Height [h]	10 mm
Length [l]	25 mm

Notes

Notes on operation	In accordance with IEC 61984, COMBICON connectors have no switching power (COC). During designated use, they must not be plugged in or disconnected when carrying voltage or under load.
--------------------	--

Environmental and real-life conditions

Ambient conditions

Ambient temperature (storage/transport)	-40 °C ... 70 °C
Relative humidity (storage/transport)	30 % ... 70 %
Ambient temperature (assembly)	-5 °C ... 100 °C
Ambient temperature (operation)	-40 °C ... 100 °C (dependent on the derating curve)

Electrical tests

Air clearances and creepage distances |

Specification	IEC 60664-1:2007-04
Insulating material group	I

MSTBC 2,5/ 4-ST-5,08 - PCB connector



1808832

<https://www.phoenixcontact.com/us/products/1808832>

Comparative tracking index (IEC 60112)	CTI 600
Rated insulation voltage (III/3)	320 V
Rated surge voltage (III/3)	4 kV
minimum clearance value - non-homogenous field (III/3)	3 mm
minimum creepage distance (III/3)	4 mm
Rated insulation voltage (III/2)	320 V
Rated surge voltage (III/2)	4 kV
minimum clearance value - non-homogenous field (III/2)	3 mm
minimum creepage distance (III/2)	3 mm
Rated insulation voltage (II/2)	630 V
Rated surge voltage (II/2)	4 kV
minimum clearance value - non-homogenous field (II/2)	3 mm
minimum creepage distance (II/2)	3.2 mm

Packaging specifications

Type of packaging	packed in cardboard
-------------------	---------------------

Drawings



Type: MSTBC 2,5/...-ST-5,08 with MSTBA 2,5/...-G-5,08; contact: MSTBC-MT 1,5 - 2,5

MSTBC 2,5/ 4-ST-5,08 - PCB connector



1808832

<https://www.phoenixcontact.com/us/products/1808832>

Approvals

To download certificates, visit the product detail page: <https://www.phoenixcontact.com/us/products/1808832>

 cULus Recognized Approval ID: E60425-19930525				
	Nominal voltage U_N	Nominal current I_N	Cross section AWG	Cross section mm^2
B	300 V	10 A	20 - 14	-
D	300 V	10 A	20 - 14	-

 CSA Approval ID: 13631				
	Nominal voltage U_N	Nominal current I_N	Cross section AWG	Cross section mm^2
keine	300 V	10 A	20 - 14	-

 VDE approval of drawings Approval ID: 40050648				
--	--	--	--	--

MSTBC 2,5/ 4-ST-5,08 - PCB connector



1808832

<https://www.phoenixcontact.com/us/products/1808832>

Classifications

ECLASS

ECLASS-13.0	27460202
ECLASS-15.0	27460202

ETIM

ETIM 10.0	EC002638
-----------	----------

UNSPSC

UNSPSC 21.0	39121400
-------------	----------

MSTBC 2,5/ 4-ST-5,08 - PCB connector



1808832

<https://www.phoenixcontact.com/us/products/1808832>

Environmental product compliance

EU RoHS

Fulfills EU RoHS substance requirements	Yes, No exemptions
---	--------------------

China RoHS

Environment friendly use period (EFUP)	EFUP-E
	No hazardous substances above the limits

EU REACH SVHC

REACH candidate substance (CAS No.)	No substance above 0.1 wt%
-------------------------------------	----------------------------

EF3.1 Climate Change

CO2e kg	0.012 kg CO2e
---------	---------------

Phoenix Contact 2026 © - all rights reserved
<https://www.phoenixcontact.com>

Phoenix Contact USA
586 Fulling Mill Road
Middletown, PA 17057, United States
(+717) 944-1300
info@phoenixcon.com