

# MSTBC 2,5/ 2-ST-5,08 - PCB connector

1808816

<https://www.phoenixcontact.com/us/products/1808816>

Please be informed that the data shown in this PDF document is generated from our online catalog. Please find the complete data in the user documentation. Our general terms of use for downloads are valid.

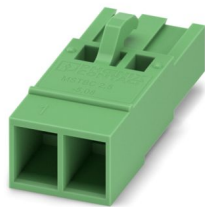

PCB connector, nominal cross section: 2.5 mm<sup>2</sup>, color: green, nominal current: 12 A, rated voltage (III/2): 320 V, contact connection type: Socket, number of potentials: 2, number of rows: 1, number of positions: 2, number of connections: 2, product range: MSTBC 2,5/-ST, pitch: 5.08 mm, connection method: Crimp connection, conductor/PCB connection direction: 0 °, locking clip: - Locking clip, plug-in system: COMBICON MSTB 2,5, locking: without, mounting method: without, type of packaging: packed in cardboard, Corresponding female crimp contacts with current [A] and conductor cross-section range [mm<sup>2</sup>] data: 10A/MSTBC-MT 0,5-1,0 (3190564); 10A/MSTBC-MT 0,5-1,0 BA (3190645); 12A/MSTBC-MT 1,5-2,5 (3190551); 12A/MSTBC-MT 1,5-2,5 BA (3190658). BA = Bandkontakte

## Your advantages

- Inexpensive connection of large quantities of preassembled conductors

## Commercial data

Item number	1808816
Packing unit	50 pc
Minimum order quantity	50 pc
Sales key	AA03
Product key	AACCEA
GTIN	4017918047160
Weight per piece (including packing)	1.2 g
Weight per piece (excluding packing)	0.89 g
Customs tariff number	85389099
Country of origin	PL

# MSTBC 2,5/ 2-ST-5,08 - PCB connector



1808816

<https://www.phoenixcontact.com/us/products/1808816>

## Technical data

### Product properties

Product type	PCB connector
Product family	MSTBC 2,5/..-ST
Product line	COMBICON Connectors M
Type	Standard
Number of positions	2
Pitch	5.08 mm
Number of connections	2
Number of rows	1
Number of potentials	2
Mounting type	without

### Electrical properties

#### Properties

Nominal current $I_N$	12 A
Nominal voltage $U_N$	320 V
Rated voltage (III/3)	320 V
Rated surge voltage (III/3)	4 kV
Rated voltage (III/2)	320 V
Rated surge voltage (III/2)	4 kV
Rated voltage (II/2)	630 V
Rated surge voltage (II/2)	4 kV

### Connection data

#### Connection technology

Type	Standard
Connector system	COMBICON MSTB 2,5 COMBICON MSTB 2,5
Nominal cross section	2.5 mm <sup>2</sup>
Contact connection type	Socket

#### Interlock

Locking type	without
Mounting type	without

#### Conductor connection

Connection method	Crimp connection
Conductor/PCB connection direction	0 °
Conductor cross-section flexible	0.5 mm <sup>2</sup> ... 2.5 mm <sup>2</sup>
Conductor cross-section AWG	20 ... 14

# MSTBC 2,5/ 2-ST-5,08 - PCB connector

1808816

<https://www.phoenixcontact.com/us/products/1808816>

## Material specifications

### Material data - contact

Metal surface contact area (top layer)	Tin (Sn)
--	----------

### Material data - housing

Color (Housing)	green (6021)
Insulating material	PA
Insulating material group	I
CTI according to IEC 60112	600
Flammability rating according to UL 94	V0
Glow wire flammability index GWFI according to EN 60695-2-12	850
Glow wire ignition temperature GWIT according to EN 60695-2-13	775
Temperature for the ball pressure test according to EN 60695-10-2	125 °C

## Dimensions

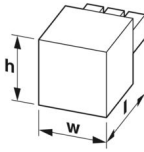
Dimensional drawing	
Pitch	5.08 mm
Width [w]	10.16 mm
Height [h]	10 mm
Length [l]	25 mm

## Notes

Notes on operation	In accordance with IEC 61984, COMBICON connectors have no switching power (COC). During designated use, they must not be plugged in or disconnected when carrying voltage or under load.
--------------------	--

## Environmental and real-life conditions

### Ambient conditions

Ambient temperature (storage/transport)	-40 °C ... 70 °C
Relative humidity (storage/transport)	30 % ... 70 %
Ambient temperature (assembly)	-5 °C ... 100 °C
Ambient temperature (operation)	-40 °C ... 100 °C (dependent on the derating curve)

## Electrical tests

### Air clearances and creepage distances |

Specification	IEC 60664-1:2007-04
Insulating material group	I

# MSTBC 2,5/ 2-ST-5,08 - PCB connector



1808816

<https://www.phoenixcontact.com/us/products/1808816>

Comparative tracking index (IEC 60112)	CTI 600
Rated insulation voltage (III/3)	320 V
Rated surge voltage (III/3)	4 kV
minimum clearance value - non-homogenous field (III/3)	3 mm
minimum creepage distance (III/3)	4 mm
Rated insulation voltage (III/2)	320 V
Rated surge voltage (III/2)	4 kV
minimum clearance value - non-homogenous field (III/2)	3 mm
minimum creepage distance (III/2)	3 mm
Rated insulation voltage (II/2)	630 V
Rated surge voltage (II/2)	4 kV
minimum clearance value - non-homogenous field (II/2)	3 mm
minimum creepage distance (II/2)	3.2 mm

## Packaging specifications

Type of packaging	packed in cardboard
-------------------	---------------------

# MSTBC 2,5/ 2-ST-5,08 - PCB connector



1808816

<https://www.phoenixcontact.com/us/products/1808816>

## Drawings



Type: MSTBC 2,5/...-ST-5,08 with MSTBA 2,5/...-G-5,08; contact: MSTBC-MT 1,5 - 2,5

# MSTBC 2,5/ 2-ST-5,08 - PCB connector



1808816

<https://www.phoenixcontact.com/us/products/1808816>

## Approvals

To download certificates, visit the product detail page: <https://www.phoenixcontact.com/us/products/1808816>

 <b>cULus Recognized</b> Approval ID: E60425-19930525				
	Nominal voltage $U_N$	Nominal current $I_N$	Cross section AWG	Cross section $\text{mm}^2$
B	300 V	10 A	20 - 14	-
D	300 V	10 A	20 - 14	-

 <b>CSA</b> Approval ID: 13631				
	Nominal voltage $U_N$	Nominal current $I_N$	Cross section AWG	Cross section $\text{mm}^2$
keine	300 V	10 A	20 - 14	-

 <b>VDE approval of drawings</b> Approval ID: 40050648				
--	--	--	--	--

# MSTBC 2,5/ 2-ST-5,08 - PCB connector



1808816

<https://www.phoenixcontact.com/us/products/1808816>

## Classifications

### ECLASS

ECLASS-13.0	27460202
ECLASS-15.0	27460202

### ETIM

ETIM 10.0	EC002638
-----------	----------

### UNSPSC

UNSPSC 21.0	39121400
-------------	----------

# MSTBC 2,5/ 2-ST-5,08 - PCB connector



1808816

<https://www.phoenixcontact.com/us/products/1808816>

## Environmental product compliance

### EU RoHS

Fulfills EU RoHS substance requirements	Yes, No exemptions
---	--------------------

### China RoHS

Environment friendly use period (EFUP)	EFUP-E
	No hazardous substances above the limits

### EU REACH SVHC

REACH candidate substance (CAS No.)	No substance above 0.1 wt%
-------------------------------------	----------------------------

### EF3.1 Climate Change

CO2e kg	0.006 kg CO2e
---------	---------------

Phoenix Contact 2026 © - all rights reserved  
<https://www.phoenixcontact.com>

Phoenix Contact USA  
586 Fulling Mill Road  
Middletown, PA 17057, United States  
(+717) 944-1300  
[info@phoenixcon.com](mailto:info@phoenixcon.com)