

FKC 2,5/ 5-STF-5,08 EX - PCB connector



1796021

<https://www.phoenixcontact.com/us/products/1796021>

Please be informed that the data shown in this PDF document is generated from our online catalog. Please find the complete data in the user documentation. Our general terms of use for downloads are valid.



PCB connector, nominal cross section: 2.5 mm², color: green, nominal current: 12 A, contact surface: Sn, contact connection type: Socket, number of potentials: 5, number of rows: 1, number of positions: 5, number of connections: 5, product range: FKC 2,5/..-STF-EX, pitch: 5.08 mm, connection method: Push-in spring connection, conductor/PCB connection direction: 0 °, locking clip: - Locking clip, plug-in system: COMBICON MSTB 2,5 EX, locking: Screw locking mechanism, mounting method: Screw flange, type of packaging: packed in cardboard

Your advantages

- Satisfies the more stringent safety requirements of "Ex eb" protection according to IEC 60079-7 for potentially explosive areas
- Time saving push-in connection, tools not required
- Intuitive operation due to color-coded actuating push button
- Quick and convenient testing using integrated test option
- Can be combined with the MSTB 2,5 range
- Screwable flange for superior mechanical stability

Commercial data

Item number	1796021
Packing unit	50 pc
Minimum order quantity	50 pc
Note	Made to order (non-returnable)
Sales key	AA03
Product key	AACFBF
GTIN	4046356635332
Weight per piece (including packing)	10.08 g
Weight per piece (excluding packing)	9.394 g
Customs tariff number	85366990
Country of origin	DE

FKC 2,5/ 5-STF-5,08 EX - PCB connector



1796021

<https://www.phoenixcontact.com/us/products/1796021>

Technical data

Product properties

Product type	PCB connector
Product family	FKC 2,5/...-STF-EX
Product line	COMBICON Connectors M
Type	Standard
Number of positions	5
Pitch	5.08 mm
Number of connections	5
Number of rows	1
Number of potentials	5
Mounting type	Screw flange

Electrical properties

Properties

Nominal current I_N	12 A
Nominal voltage U_N	176 V
Rated current / conductor cross-section	12 A/2.5 mm ²

Ex data

Ex approval

Identification	0344 [Ⓢ] II 2GD / Ex eb IIC Gb
EU-type examination certificate	KEMA 10ATEX0196 U
IECEX certificate	IECEX KEM 10.0093U

Connection data

Connection technology

Type	Standard
Connector system	COMBICON MSTB 2,5 EX
Nominal cross section	2.5 mm ²
Contact connection type	Socket

Interlock

Locking type	Screw locking mechanism
Mounting type	Screw flange
Tightening torque	0.25 Nm ... 0.3 Nm (In extreme climatic conditions, we recommend the minimum tightening torque.)

Conductor connection

Connection method	Push-in spring connection
Conductor/PCB connection direction	0 °
Conductor cross-section rigid	0.2 mm ² ... 2.5 mm ²

FKC 2,5/ 5-STF-5,08 EX - PCB connector



1796021

<https://www.phoenixcontact.com/us/products/1796021>

Conductor cross-section flexible	0.2 mm ² ... 2.5 mm ²
Conductor cross-section AWG	24 ... 12
Conductor cross-section, flexible, with ferrule, without plastic sleeve	0.25 mm ² ... 2.5 mm ²
Conductor cross-section, flexible, with ferrule, with plastic sleeve	0.25 mm ² ... 2.5 mm ²
2 conductors with the same cross section, flexible, with TWIN ferrule with plastic sleeve	0.5 mm ² ... 1.5 mm ²
Stripping length	10 mm

Specifications for ferrules without insulating collar

recommended crimping tool	1212034 CRIMPFOX 6
---------------------------	--------------------

Specifications for ferrules with insulating collar

recommended crimping tool	1212034 CRIMPFOX 6
---------------------------	--------------------

Material specifications

Material data - contact

Note	WEEE/RoHS-compliant, free of whiskers according to IEC 60068-2-82/JEDEC JESD 201
Contact material	Cu alloy
Surface characteristics	hot-dip tin-plated
Metal surface terminal point (top layer)	Tin (4 µm - 8 µm Sn)
Metal surface contact area (top layer)	Tin (4 µm - 8 µm Sn)

Material data - housing

Color (Housing)	green (6021)
Insulating material	PA
Insulating material group	I
CTI according to IEC 60112	600
Flammability rating according to UL 94	V0
Glow wire flammability index GWFI according to EN 60695-2-12	850
Glow wire ignition temperature GWIT according to EN 60695-2-13	775
Temperature for the ball pressure test according to EN 60695-10-2	125 °C

Material data – actuating element

Color (Actuating element)	orange (2003)
Insulating material	PBT
Insulating material group	I
CTI according to IEC 60112	600
Flammability rating according to UL 94	V0

Dimensions

FKC 2,5/ 5-STF-5,08 EX - PCB connector



1796021

<https://www.phoenixcontact.com/us/products/1796021>

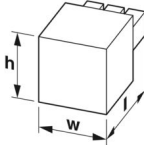
Dimensional drawing		
Pitch		5.08 mm
Width [w]		35.5 mm
Height [h]		15 mm
Length [l]		25.23 mm

Mounting

Flange

Tightening torque	0.25 Nm ... 0.3 Nm (In extreme climatic conditions, we recommend the minimum tightening torque.)
-------------------	--

Notes

Notes on operation	In accordance with IEC 61984, COMBICON connectors have no switching power (COC). During designated use, they must not be plugged in or disconnected when carrying voltage or under load.
--------------------	--

Environmental and real-life conditions

Ambient conditions

Relative humidity (storage/transport)	30 % ... 70 %
---------------------------------------	---------------

Packaging specifications

Type of packaging	packed in cardboard
-------------------	---------------------

FKC 2,5/ 5-STF-5,08 EX - PCB connector



1796021

<https://www.phoenixcontact.com/us/products/1796021>

Approvals

To download certificates, visit the product detail page: <https://www.phoenixcontact.com/us/products/1796021>

 ATEX Approval ID: KEMA 10ATEX0196 U				
	Nominal voltage U_N	Nominal current I_N	Cross section AWG	Cross section mm^2
keine				
	176 V	12 A	-	0.2 - 2.5

 IECEx Approval ID: IECEx KEM 10.0093U				
	Nominal voltage U_N	Nominal current I_N	Cross section AWG	Cross section mm^2
keine				
	176 V	12 A	-	0.2 - 2.5

 CCC Approval ID: 2021122313114375				
---	--	--	--	--

FKC 2,5/ 5-STF-5,08 EX - PCB connector



1796021

<https://www.phoenixcontact.com/us/products/1796021>

Classifications

ECLASS

ECLASS-13.0	27460202
ECLASS-15.0	27460202

ETIM

ETIM 10.0	EC002638
-----------	----------

UNSPSC

UNSPSC 21.0	39121400
-------------	----------

FKC 2,5/ 5-STF-5,08 EX - PCB connector



1796021

<https://www.phoenixcontact.com/us/products/1796021>

Environmental product compliance

EU RoHS

Fulfills EU RoHS substance requirements	Yes, No exemptions
---	--------------------

China RoHS

Environment friendly use period (EFUP)	EFUP-E
	No hazardous substances above the limits

EU REACH SVHC

REACH candidate substance (CAS No.)	No substance above 0.1 wt%
-------------------------------------	----------------------------

EF3.1 Climate Change

CO2e kg	0.059 kg CO2e
---------	---------------

Phoenix Contact 2026 © - all rights reserved
<https://www.phoenixcontact.com>

Phoenix Contact USA
586 Fulling Mill Road
Middletown, PA 17057, United States
(+717) 944-1300
info@phoenixcon.com