

# GMSTB 2,5/ 8-STF-7,62 EX - PCB connector



1795831

<https://www.phoenixcontact.com/us/products/1795831>

Please be informed that the data shown in this PDF document is generated from our online catalog. Please find the complete data in the user documentation. Our general terms of use for downloads are valid.



PCB connector, nominal cross section: 2.5 mm<sup>2</sup>, color: green, nominal current: 12 A, contact surface: Sn, contact connection type: Socket, number of potentials: 8, number of rows: 1, number of positions: 8, number of connections: 8, product range: GMSTB 2,5/...-STF-EX, pitch: 7.62 mm, connection method: Screw connection with tension sleeve, screw head form: L Slotted, conductor/PCB connection direction: 0 °, locking clip: - without locking clip, plug-in system: COMBICON MSTB 2,5 EX, locking: Screw locking mechanism, mounting method: Screw flange, type of packaging: packed in cardboard

## Your advantages

- Well-known connection principle allows worldwide use
- Low temperature rise, thanks to maximum contact force
- Screwable flange for superior mechanical stability
- Larger pitch for increased voltage requirements
- Allows connection of two conductors
- Satisfies the more stringent safety requirements of "Ex eb" protection according to IEC 60079-7 for potentially explosive areas

## Commercial data

|                                      |                                |
|--------------------------------------|--------------------------------|
| Item number                          | 1795831                        |
| Packing unit                         | 50 pc                          |
| Minimum order quantity               | 50 pc                          |
| Note                                 | Made to order (non-returnable) |
| Sales key                            | AA03                           |
| Product key                          | AACAIG                         |
| GTIN                                 | 4046356635707                  |
| Weight per piece (including packing) | 16.728 g                       |
| Weight per piece (excluding packing) | 16.65 g                        |
| Customs tariff number                | 85366990                       |
| Country of origin                    | DE                             |

# GMSTB 2,5/ 8-STF-7,62 EX - PCB connector



1795831

<https://www.phoenixcontact.com/us/products/1795831>

## Technical data

### Product properties

|                       |                       |
|-----------------------|-----------------------|
| Product type          | PCB connector         |
| Product family        | GMSTB 2,5/...-STF-EX  |
| Product line          | COMBICON Connectors M |
| Type                  | Standard              |
| Number of positions   | 8                     |
| Pitch                 | 7.62 mm               |
| Number of connections | 8                     |
| Number of rows        | 1                     |
| Number of potentials  | 8                     |
| Mounting type         | Screw flange          |

### Electrical properties

#### Properties

|   |                          |
|---|--------------------------|
| Nominal current $I_N$                   | 12 A                     |
| Nominal voltage $U_N$                   | 352 V                    |
| Rated current / conductor cross-section | 12 A/2.5 mm <sup>2</sup> |

### Ex data

#### Ex approval

|                                 |  |
|---------------------------------|--|
| Identification                  | 0344 <sup>CE</sup> II 2GD / Ex eb IIC Gb |
| EU-type examination certificate | KEMA 10ATEX0196 U                        |
| IECEx certificate               | IECEx KEM 10.0093U                       |

### Connection data

#### Connection technology

|                         |                      |
|-------------------------|----------------------|
| Type                    | Standard             |
| Connector system        | COMBICON MSTB 2,5 EX |
| Nominal cross section   | 2.5 mm <sup>2</sup>  |
| Contact connection type | Socket               |

#### Interlock

|                   |                         |
|-------------------|-------------------------|
| Locking type      | Screw locking mechanism |
| Mounting type     | Screw flange            |
| Tightening torque | 0.3 Nm                  |

#### Conductor connection

|                                    |   |
|------------------------------------|---|
| Connection method                  | Screw connection with tension sleeve        |
| Conductor/PCB connection direction | 0 °   |
| Conductor cross-section rigid      | 0.2 mm <sup>2</sup> ... 2.5 mm <sup>2</sup> |
| Conductor cross-section flexible   | 0.2 mm <sup>2</sup> ... 2.5 mm <sup>2</sup> |

# GMSTB 2,5/ 8-STF-7,62 EX - PCB connector



1795831

<https://www.phoenixcontact.com/us/products/1795831>

|   |  |
|---|--|
| Conductor cross-section AWG   | 24 ... 12                                    |
| Conductor cross-section, flexible, with ferrule, without plastic sleeve                   | 0.25 mm <sup>2</sup> ... 2.5 mm <sup>2</sup> |
| Conductor cross-section, flexible, with ferrule, with plastic sleeve                      | 0.25 mm <sup>2</sup> ... 2.5 mm <sup>2</sup> |
| 2 conductors with same cross section, rigid   | 0.2 mm <sup>2</sup> ... 1 mm <sup>2</sup>    |
| 2 conductors with same cross section, flexible  | 0.2 mm <sup>2</sup> ... 1.5 mm <sup>2</sup>  |
| 2 conductors with same cross section, flexible, with ferrule without plastic sleeve       | 0.25 mm <sup>2</sup> ... 1 mm <sup>2</sup>   |
| 2 conductors with the same cross section, flexible, with TWIN ferrule with plastic sleeve | 0.5 mm <sup>2</sup> ... 1 mm <sup>2</sup>    |
| Cylindrical gauge a x b / diameter  | 2.8 mm x 2.0 mm / 2.4 mm                     |
| Stripping length  | 7 mm   |
| Drive form screw head   | Slotted (L)                                  |
| Tightening torque   | 0.5 Nm ... 0.6 Nm                            |

## Specifications for ferrules without insulating collar

|                           |                    |
|---------------------------|--------------------|
| recommended crimping tool | 1212034 CRIMPFOX 6 |
|---------------------------|--------------------|

## Specifications for ferrules with insulating collar

|                           |                    |
|---------------------------|--------------------|
| recommended crimping tool | 1212034 CRIMPFOX 6 |
|---------------------------|--------------------|

## Material specifications

### Material data - contact

|  |  |
|--|--|
| Note                                     | WEEE/RoHS-compliant, free of whiskers according to IEC 60068-2-82/JEDEC JESD 201 |
| Contact material                         | Cu alloy   |
| Surface characteristics                  | hot-dip tin-plated   |
| Metal surface terminal point (top layer) | Tin (4 µm - 8 µm Sn)   |
| Metal surface contact area (top layer)   | Tin (4 µm - 8 µm Sn)   |

### Material data - housing

|   |              |
|---|--------------|
| Color (Housing)   | green (6021) |
| Insulating material   | PA           |
| Insulating material group   | I            |
| CTI according to IEC 60112  | 600          |
| Flammability rating according to UL 94                            | V0           |
| Glow wire flammability index GWFI according to EN 60695-2-12      | 850          |
| Glow wire ignition temperature GWIT according to EN 60695-2-13    | 775          |
| Temperature for the ball pressure test according to EN 60695-10-2 | 125 °C       |

## Dimensions

# GMSTB 2,5/ 8-STF-7,62 EX - PCB connector



1795831

<https://www.phoenixcontact.com/us/products/1795831>

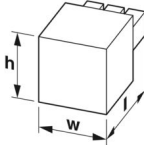
|                     |  |
|---------------------|--|
| Dimensional drawing |  |
| Pitch               | 7.62 mm  |
| Width [w]           | 71.35 mm   |
| Height [h]          | 15 mm  |
| Length [l]          | 18.2 mm  |

## Mounting

### Flange

|                   |        |
|-------------------|--------|
| Tightening torque | 0.3 Nm |
|-------------------|--------|

## Notes

|                    |  |
|--------------------|--|
| Notes on operation | In accordance with IEC 61984, COMBICON connectors have no switching power (COC). During designated use, they must not be plugged in or disconnected when carrying voltage or under load. |
|--------------------|--|

## Environmental and real-life conditions

### Ambient conditions

|   |                   |
|---|-------------------|
| Ambient temperature (storage/transport) | -40 °C ... 70 °C  |
| Relative humidity (storage/transport)   | 30 % ... 70 %     |
| Ambient temperature (assembly)          | -5 °C ... 100 °C  |
| Ambient temperature (operation)         | -60 °C ... 110 °C |

## Packaging specifications

|                   |                     |
|-------------------|---------------------|
| Type of packaging | packed in cardboard |
|-------------------|---------------------|

# GMSTB 2,5/ 8-STF-7,62 EX - PCB connector



1795831

<https://www.phoenixcontact.com/us/products/1795831>

## Approvals

To download certificates, visit the product detail page: <https://www.phoenixcontact.com/us/products/1795831>

|  <b>ATEX</b><br>Approval ID: KEMA 10ATEX0196 U |                       |                       |                   |                             |
|---|-----------------------|-----------------------|-------------------|-----------------------------|
|   | Nominal voltage $U_N$ | Nominal current $I_N$ | Cross section AWG | Cross section $\text{mm}^2$ |
| keine   |                       |                       |                   |                             |
|   | 352 V                 | 12 A                  | -                 | 0.2 - 2.5                   |

|  <b>IECEx</b><br>Approval ID: IECEx KEM 10.0093U |                       |                       |                   |                             |
|---|-----------------------|-----------------------|-------------------|-----------------------------|
|   | Nominal voltage $U_N$ | Nominal current $I_N$ | Cross section AWG | Cross section $\text{mm}^2$ |
| keine   |                       |                       |                   |                             |
|   | 352 V                 | 12 A                  | -                 | 0.2 - 2.5                   |

|  <b>CCC</b><br>Approval ID: 2021122313114375 |  |  |  |  |
|---|--|--|--|--|
|---|--|--|--|--|

# GMSTB 2,5/ 8-STF-7,62 EX - PCB connector



1795831

<https://www.phoenixcontact.com/us/products/1795831>

## Classifications

### ECLASS

|             |          |
|-------------|----------|
| ECLASS-13.0 | 27460202 |
| ECLASS-15.0 | 27460202 |

### ETIM

|           |          |
|-----------|----------|
| ETIM 10.0 | EC002638 |
|-----------|----------|

### UNSPSC

|             |          |
|-------------|----------|
| UNSPSC 21.0 | 39121400 |
|-------------|----------|

# GMSTB 2,5/ 8-STF-7,62 EX - PCB connector



1795831

<https://www.phoenixcontact.com/us/products/1795831>

## Environmental product compliance

### EU RoHS

|   |                    |
|---|--------------------|
| Fulfills EU RoHS substance requirements | Yes, No exemptions |
|---|--------------------|

### China RoHS

|  |  |
|--|--|
| Environment friendly use period (EFUP) | EFUP-E                                   |
|  | No hazardous substances above the limits |

### EU REACH SVHC

|                                     |                            |
|-------------------------------------|----------------------------|
| REACH candidate substance (CAS No.) | No substance above 0.1 wt% |
|-------------------------------------|----------------------------|

### EF3.1 Climate Change

|         |               |
|---------|---------------|
| CO2e kg | 0.102 kg CO2e |
|---------|---------------|

Phoenix Contact 2026 © - all rights reserved  
<https://www.phoenixcontact.com>

Phoenix Contact USA  
586 Fulling Mill Road  
Middletown, PA 17057, United States  
(+717) 944-1300  
[info@phoenixcon.com](mailto:info@phoenixcon.com)