

MC 1,5/ 4-GF-3,5 P14 THR - PCB header



1789643

<https://www.phoenixcontact.com/us/products/1789643>

Please be informed that the data shown in this PDF document is generated from our online catalog. Please find the complete data in the user documentation. Our general terms of use for downloads are valid.

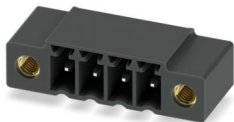

PCB headers, nominal cross section: 1.5 mm², color: black, nominal current: 8 A, rated voltage (III/2): 160 V, contact surface: Sn, contact connection type: Pin, number of potentials: 4, number of rows: 1, number of positions: 4, number of connections: 4, product range: MC 1,5/..-GF-THR, pitch: 3.5 mm, mounting: THR soldering / wave soldering, pin layout: Linear pinning, solder pin [P]: 1.4 mm, number of solder pins per potential: 1, plug-in system: COMBICON MC 1,5, Pin connector pattern alignment: Standard, locking: Screw locking mechanism, mounting method: Threaded flange, type of packaging: packed in cardboard

Your advantages

- Designed for integration into the SMT soldering process
- Screwable flange for superior mechanical stability
- Maximum flexibility when it comes to device design – one header for connectors with different connection technologies

Commercial data

| | |
|--------------------------------------|---------------|
| Item number | 1789643 |
| Packing unit | 250 pc |
| Minimum order quantity | 50 pc |
| Sales key | AA02 |
| Product key | AABTAA |
| GTIN | 4046356611213 |
| Weight per piece (including packing) | 2.265 g |
| Weight per piece (excluding packing) | 2.07 g |
| Customs tariff number | 85366930 |
| Country of origin | DE |

MC 1,5/ 4-GF-3,5 P14 THR - PCB header



1789643

<https://www.phoenixcontact.com/us/products/1789643>

Technical data

Product properties

| | |
|---------------------------|--|
| Product type | PCB headers |
| Product family | MC 1,5/..-GF-THR |
| Product line | COMBICON Connectors S |
| Type | Component suitable for through hole reflow |
| Number of positions | 4 |
| Pitch | 3.5 mm |
| Number of connections | 4 |
| Number of rows | 1 |
| Number of potentials | 4 |
| Mounting type | Threaded flange |
| Pin layout | Linear pinning |
| Solder pins per potential | 1 |

Electrical properties

Properties

| | |
|-----------------------------|----------------|
| Nominal current I_N | 8 A |
| Nominal voltage U_N | 160 V |
| Contact resistance | 2.2 m Ω |
| Rated voltage (III/3) | 160 V |
| Rated surge voltage (III/3) | 2.5 kV |
| Rated voltage (III/2) | 160 V |
| Rated surge voltage (III/2) | 2.5 kV |
| Rated voltage (II/2) | 250 V |
| Rated surge voltage (II/2) | 2.5 kV |

Mounting

| | |
|---------------|--------------------------------|
| Mounting type | THR soldering / wave soldering |
| Pin layout | Linear pinning |

Flange

| | |
|-------------------|--------|
| Tightening torque | 0.3 Nm |
|-------------------|--------|

Processing notes

| | |
|----------------------------------|-----------------------|
| Process | Reflow/wave soldering |
| Moisture Sensitive Level | MSL 1 |
| Classification temperature T_c | 260 °C |
| Solder cycles in the reflow | 3 |

Material specifications

Material data - contact

MC 1,5/ 4-GF-3,5 P14 THR - PCB header

1789643

<https://www.phoenixcontact.com/us/products/1789643>

| | |
|---|--|
| Note | WEEE/RoHS-compliant, free of whiskers according to IEC 60068-2-82/JEDEC JESD 201 |
| Contact material | Cu alloy |
| Surface characteristics | Tin-plated |
| Metal surface contact area (top layer) | Tin (3 µm - 5 µm Sn) |
| Metal surface contact area (middle layer) | Nickel (1.3 µm - 3 µm Ni) |
| Metal surface soldering area (top layer) | Tin (3 µm - 5 µm Sn) |
| Metal surface soldering area (middle layer) | Nickel (1.3 µm - 3 µm Ni) |

Material data - housing

| | |
|--|--------------|
| Color (Housing) | black (9005) |
| Insulating material | LCP |
| Insulating material group | IIIa |
| CTI according to IEC 60112 | 175 |
| Flammability rating according to UL 94 | V0 |

Dimensions

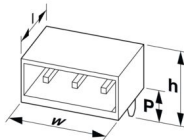
| | |
|-----------------------|--|
| Dimensional drawing |  |
| Pitch | 3.5 mm |
| Width [w] | 24.3 mm |
| Height [h] | 8.3 mm |
| Length [l] | 9.2 mm |
| Installed height | 6.9 mm |
| Solder pin length [P] | 1.4 mm |
| Pin dimensions | 0.8 x 0.8 mm |

PCB design

| | |
|---------------|--------|
| Hole diameter | 1.4 mm |
|---------------|--------|

Mechanical tests

Visual inspection

| | |
|---------------|-----------------------|
| Specification | IEC 60512-1-1:2002-02 |
| Result | Test passed |

Dimension check

| | |
|---------------|-----------------------|
| Specification | IEC 60512-1-2:2002-02 |
| Result | Test passed |

Resistance of inscriptions

| | |
|---------------|------------------------|
| Specification | IEC 60068-2-70:1995-12 |
| Result | Test passed |

MC 1,5/ 4-GF-3,5 P14 THR - PCB header



1789643

<https://www.phoenixcontact.com/us/products/1789643>

Polarization and coding

| | |
|---------------|------------------------|
| Specification | IEC 60512-13-5:2006-02 |
| Result | Test passed |

Contact holder in insert

| | |
|---|------------------------|
| Specification | IEC 60512-15-1:2008-05 |
| Contact holder in insert Requirements >20 N | Test passed |

Insertion and withdrawal forces

| | |
|-------------------------------------|------------------------|
| Specification | IEC 60512-13-2:2006-02 |
| Result | Test passed |
| No. of cycles | 25 |
| Insertion strength per pos. approx. | 8 N |
| Withdraw strength per pos. approx. | 5 N |

Electrical tests

Thermal test | Test group C

| | |
|----------------------------|-----------------------|
| Specification | IEC 60512-5-1:2002-02 |
| Tested number of positions | 16 |

Insulation resistance

| | |
|--|-----------------------|
| Specification | IEC 60512-3-1:2002-02 |
| Insulation resistance, neighboring positions | > 5 MΩ |

Air clearances and creepage distances |

| | |
|--|---------------------|
| Specification | IEC 60664-1:2007-04 |
| Insulating material group | IIIa |
| Comparative tracking index (IEC 60112) | CTI 175 |
| Rated insulation voltage (III/3) | 160 V |
| Rated surge voltage (III/3) | 2.5 kV |
| minimum clearance value - non-homogenous field (III/3) | 1.5 mm |
| minimum creepage distance (III/3) | 2.5 mm |
| Rated insulation voltage (III/2) | 160 V |
| Rated surge voltage (III/2) | 2.5 kV |
| minimum clearance value - non-homogenous field (III/2) | 1.5 mm |
| minimum creepage distance (III/2) | 1.6 mm |
| Rated insulation voltage (II/2) | 250 V |
| Rated surge voltage (II/2) | 2.5 kV |
| minimum clearance value - non-homogenous field (II/2) | 1.5 mm |
| minimum creepage distance (II/2) | 2.5 mm |

Environmental and real-life conditions

Durability test

| | |
|---------------|-----------------------|
| Specification | IEC 60512-9-1:2010-03 |
|---------------|-----------------------|

MC 1,5/ 4-GF-3,5 P14 THR - PCB header



1789643

<https://www.phoenixcontact.com/us/products/1789643>

| | |
|--|---------|
| Impulse withstand voltage at sea level | 2.95 kV |
| Contact resistance R ₁ | 2.2 mΩ |
| Contact resistance R ₂ | 2.1 mΩ |
| Insertion/withdrawal cycles | 25 |
| Insulation resistance, neighboring positions | > 5 MΩ |

Climatic test

| | |
|-----------------------------------|---|
| Specification | EN ISO 22479:2022-06 |
| Corrosive stress | 0.2 dm ³ SO ₂ on 300 dm ³ /40 °C/1 cycle |
| Thermal stress | 105 °C/168 h |
| Power-frequency withstand voltage | 1.39 kV |

Vibration test

| | |
|------------------------|-----------------------------|
| Specification | IEC 60068-2-6:2007-12 |
| Frequency | 10 - 150 - 10 Hz |
| Sweep speed | 1 octave/min |
| Amplitude | 0.35 mm (10 Hz ... 60.1 Hz) |
| Acceleration | 5g (60.1 Hz ... 150 Hz) |
| Test duration per axis | 2.5 h |
| Test directions | X-, Y- and Z-axis |

Shocks

| | |
|-----------------|-----------------------------------|
| Specification | IEC 60068-2-27:2008-02 |
| Pulse shape | Semi-sinusoidal |
| Acceleration | 30g |
| Shock duration | 18 ms |
| Test directions | X-, Y- and Z-axis (pos. and neg.) |

Railway application: Oscillation/broadband noise

| | |
|------------------------|--|
| Specification | DIN EN 50155 (VDE 0115-200):2022-06 IEC 61373:2010-05 |
| Spectrum | Long life test category 1, class B, body mounted |
| Frequency | f ₁ = 5 Hz to f ₂ = 150 Hz |
| ASD level | 0.964 (m/s ²)/Hz |
| Acceleration | 0.572 g |
| Test duration per axis | 5 h |
| Test directions | X-, Y- and Z-axis |
| Contact interruption | < 1 μs |
| Result | Test passed |

Railway application: Shocks

| | |
|----------------|--|
| Specification | DIN EN 50155 (VDE 0115-200):2022-06 IEC 61373:2010-05 |
| Pulse shape | Semi-sinusoidal |
| Acceleration | 30g |
| Shock duration | 18 ms |

MC 1,5/ 4-GF-3,5 P14 THR - PCB header



1789643

<https://www.phoenixcontact.com/us/products/1789643>

| | |
|--------------------------------|-----------------------------------|
| Number of shocks per direction | 3 |
| Test directions | X-, Y- and Z-axis (pos. and neg.) |
| Contact interruption | < 1 μ s |
| Result | Test passed |

Ambient conditions

| | |
|---|---|
| Ambient temperature (storage/transport) | -40 °C ... 70 °C |
| Relative humidity (storage/transport) | 30 % ... 70 % |
| Ambient temperature (assembly) | -5 °C ... 100 °C |
| Ambient temperature (operation) | -40 °C ... 105 °C (dependent on the derating curve) |

Packaging specifications

| | |
|-------------------|---------------------|
| Type of packaging | packed in cardboard |
|-------------------|---------------------|

MC 1,5/ 4-GF-3,5 P14 THR - PCB header



1789643

<https://www.phoenixcontact.com/us/products/1789643>

Drawings

Dimensional drawing

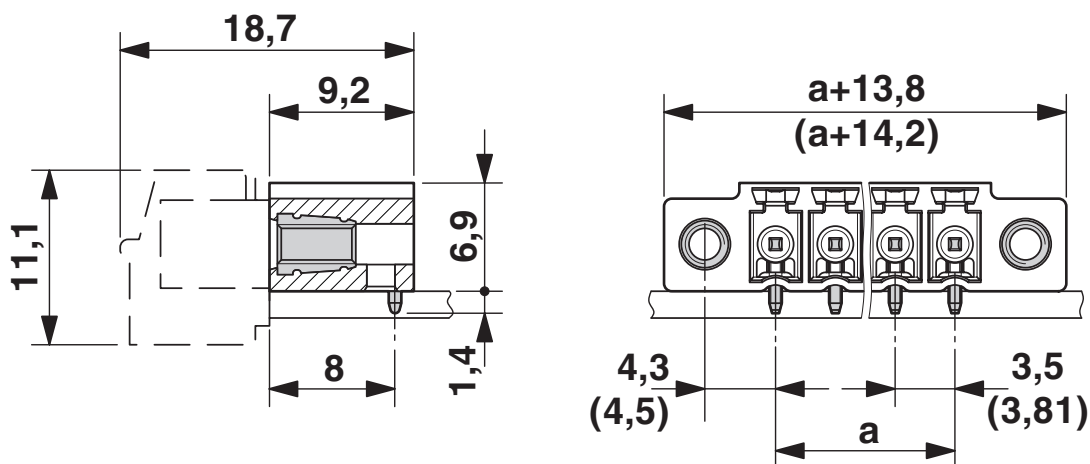

Diagram



Type: XPC 1,5/...-STF-3,5 with MC 1,5/...-GF-3,5 P... THR



Type: MC 1,5/...-ST(F)-3,5 with MC 1,5/...-G(F)-3,5 P... THR



Type: MCV(W/R) 2,5/...-STF-3,5 with MC 1,5/...-GF-3,5 P...THR



Type: FMC 1,5/...-STF-3,5 with MC 1,5/...-GF-3,5 P.. THR



Type: FMCOR 1,5/...-STF-3,5 with MC 1,5/...-GF-3,5 P... THR

MC 1,5/ 4-GF-3,5 P14 THR - PCB header



1789643

<https://www.phoenixcontact.com/us/products/1789643>



Type: FMCOW 1,5/...-STF-3,5 with MC 1,5/...-GF-3,5 P... THR

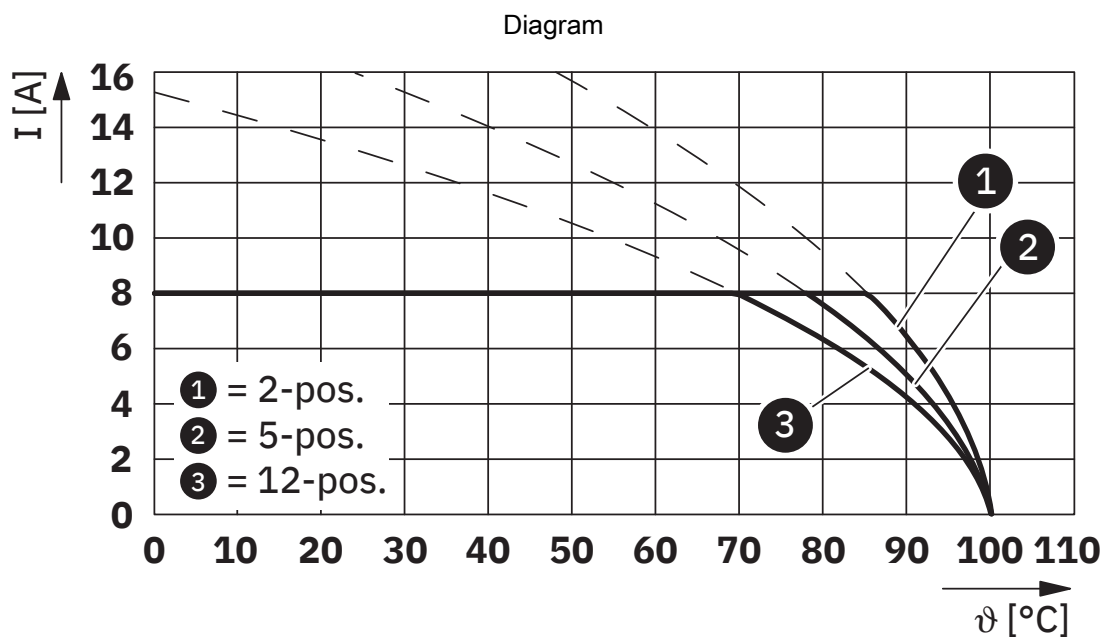

Type: FK-MCP 1,5/...-STF-3,5 with MC 1,5/...-GF-3,5 P... THR

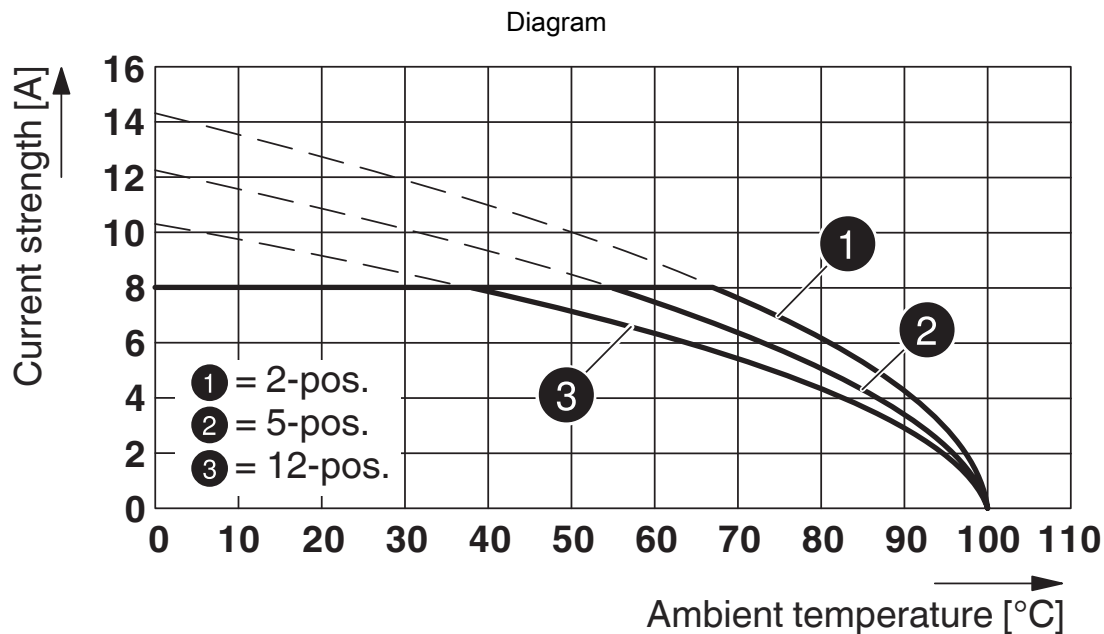

Type: MCV(W/R) 2,5/...-STF-3,5 with MC 1,5/...-GF-3,5 P...THR

Drilling plan/solder pad geometry



MC 1,5/ 4-GF-3,5 P14 THR - PCB header





1789643

<https://www.phoenixcontact.com/us/products/1789643>

Approvals

To download certificates, visit the product detail page: <https://www.phoenixcontact.com/us/products/1789643>

|  cULus Recognized Approval ID: E60425-20110128 | | | | |
|---|-----------------------|-----------------------|-------------------|-----------------------------|
| | Nominal voltage U_N | Nominal current I_N | Cross section AWG | Cross section mm^2 |
| B | 300 V | 8 A | - | - |
| D | 300 V | 8 A | - | - |

|  VDE Zeichengenehmigung Approval ID: 40011723 | | | | |
|--|-----------------------|-----------------------|-------------------|-----------------------------|
| | Nominal voltage U_N | Nominal current I_N | Cross section AWG | Cross section mm^2 |
| keine | 160 V | 8 A | - | - |

MC 1,5/ 4-GF-3,5 P14 THR - PCB header



1789643

<https://www.phoenixcontact.com/us/products/1789643>

Classifications

ECLASS

| | |
|-------------|----------|
| ECLASS-13.0 | 27460201 |
| ECLASS-15.0 | 27460201 |

ETIM

| | |
|-----------|----------|
| ETIM 10.0 | EC002637 |
|-----------|----------|

UNSPSC

| | |
|-------------|----------|
| UNSPSC 21.0 | 39121400 |
|-------------|----------|

MC 1,5/ 4-GF-3,5 P14 THR - PCB header



1789643

<https://www.phoenixcontact.com/us/products/1789643>

Environmental product compliance

EU RoHS

| | |
|---|--------------------|
| Fulfills EU RoHS substance requirements | Yes, No exemptions |
|---|--------------------|

China RoHS

| | |
|--|--|
| Environment friendly use period (EFUP) | EFUP-E |
| | No hazardous substances above the limits |

EU REACH SVHC

| | |
|-------------------------------------|----------------------------|
| REACH candidate substance (CAS No.) | No substance above 0.1 wt% |
|-------------------------------------|----------------------------|

Phoenix Contact 2026 © - all rights reserved
<https://www.phoenixcontact.com>

Phoenix Contact USA
586 Fulling Mill Road
Middletown, PA 17057, United States
(+717) 944-1300
info@phoenixcon.com