

MVSTBU 2,5/ 6-GB-5,08 - PCB header



1788570

<https://www.phoenixcontact.com/us/products/1788570>

Please be informed that the data shown in this PDF document is generated from our online catalog. Please find the complete data in the user documentation. Our general terms of use for downloads are valid.



The figure shows a 10-position version of the product

Direct plug-in block, nominal cross section: 2.5 mm², color: green, nominal current: 12 A, rated voltage (III/2): 320 V, contact surface: Sn, contact connection type: Pin, number of potentials: 6, number of rows: 1, number of positions: 6, number of connections: 6, product range: MVSTBU 2,5/...-GB, pitch: 5.08 mm, connection method: Screw connection with tension sleeve, screw head form: L Slotted, mounting: Direct mounting, conductor/PCB connection direction: 0 °, number of solder pins per potential: 1, plug-in system: COMBICON MSTB 2,5, locking: without, mounting method: without, type of packaging: packed in cardboard

Your advantages

- Direct plug-in blocks with mounting flanges for screw connection on mounting panels or unit housing
- Can be combined with the MSTB 2,5 range
- Maximum flexibility when it comes to device design – one header for connectors with different connection technologies
- Well-known connection principle allows worldwide use
- Allows connection of two conductors

Commercial data

| | |
|--------------------------------------|---------------|
| Item number | 1788570 |
| Packing unit | 50 pc |
| Minimum order quantity | 50 pc |
| Sales key | AA03 |
| Product key | AACMCA |
| GTIN | 4017918043636 |
| Weight per piece (including packing) | 13.31 g |
| Weight per piece (excluding packing) | 12.729 g |
| Customs tariff number | 85366990 |
| Country of origin | PL |

1788570

<https://www.phoenixcontact.com/us/products/1788570>

Technical data

Product properties

| | |
|---------------------------|-----------------------|
| Product type | Direct plug-in block |
| Product family | MVSTBU 2,5/..-GB |
| Product line | COMBICON Connectors M |
| Type | Direct mounting |
| Number of positions | 6 |
| Pitch | 5.08 mm |
| Number of connections | 6 |
| Number of rows | 1 |
| Number of potentials | 6 |
| Mounting type | without |
| Solder pins per potential | 1 |

Electrical properties

Properties

| | |
|-----------------------------|----------------|
| Nominal current I_N | 12 A |
| Nominal voltage U_N | 320 V |
| Contact resistance | 1.9 m Ω |
| Rated voltage (III/3) | 320 V |
| Rated surge voltage (III/3) | 4 kV |
| Rated voltage (III/2) | 320 V |
| Rated surge voltage (III/2) | 4 kV |
| Rated voltage (II/2) | 630 V |
| Rated surge voltage (II/2) | 4 kV |

Connection data

Connection technology

| | |
|-------------------------|---------------------|
| Type | Direct mounting |
| Connector system | COMBICON MSTB 2,5 |
| Nominal cross section | 2.5 mm ² |
| Contact connection type | Pin |

Interlock

| | |
|---------------|---------|
| Locking type | without |
| Mounting type | without |

Conductor connection

| | |
|--|---|
| Connection method | Screw connection with tension sleeve |
| Connection direction of the conductor to plug-in direction | 0 ° |
| Conductor cross-section rigid | 0.2 mm ² ... 2.5 mm ² |
| Conductor cross-section flexible | 0.2 mm ² ... 2.5 mm ² |

MVSTBU 2,5/ 6-GB-5,08 - PCB header



1788570

<https://www.phoenixcontact.com/us/products/1788570>

| | |
|---|--|
| Conductor cross-section AWG | 24 ... 12 |
| Conductor cross-section, flexible, with ferrule, without plastic sleeve | 0.25 mm ² ... 2.5 mm ² |
| Conductor cross-section, flexible, with ferrule, with plastic sleeve | 0.25 mm ² ... 2.5 mm ² |
| 2 conductors with same cross section, rigid | 0.2 mm ² ... 1 mm ² |
| 2 conductors with same cross section, flexible | 0.2 mm ² ... 1.5 mm ² |
| 2 conductors with same cross section, flexible, with ferrule without plastic sleeve | 0.25 mm ² ... 1 mm ² |
| 2 conductors with the same cross section, flexible, with TWIN ferrule with plastic sleeve | 0.5 mm ² ... 1 mm ² |
| Cylindrical gauge a x b / diameter | 2.8 mm x 2.0 mm / 2.4 mm |
| Stripping length | 7 mm |
| Tightening torque | 0.5 Nm ... 0.6 Nm |

Mounting

| | |
|---------------|-----------------|
| Mounting type | Direct mounting |
|---------------|-----------------|

Material specifications

Material data - contact

| | |
|---|--|
| Note | WEEE/RoHS-compliant, free of whiskers according to IEC 60068-2-82/JEDEC JESD 201 |
| Contact material | Cu alloy |
| Surface characteristics | Tin-plated |
| Metal surface terminal point (top layer) | Tin (5 µm - 7 µm Sn) |
| Metal surface terminal point (middle layer) | Nickel (2 µm - 3 µm Ni) |
| Metal surface contact area (top layer) | Tin (5 µm - 7 µm Sn) |
| Metal surface contact area (middle layer) | Nickel (2 µm - 3 µm Ni) |

Material data - housing

| | |
|---|--------------|
| Color (Housing) | green (6021) |
| Insulating material | PA |
| Insulating material group | I |
| CTI according to IEC 60112 | 600 |
| Flammability rating according to UL 94 | V0 |
| Glow wire flammability index GWFI according to EN 60695-2-12 | 850 |
| Glow wire ignition temperature GWIT according to EN 60695-2-13 | 775 |
| Temperature for the ball pressure test according to EN 60695-10-2 | 125 °C |

Notes

| | |
|--------------------|--|
| Notes on operation | In accordance with IEC 61984, COMBICON connectors have no switching power (COC). During designated use, they must not be plugged in or disconnected when carrying voltage or under load. |
|--------------------|--|

Dimensions

MVSTBU 2,5/ 6-GB-5,08 - PCB header

1788570

<https://www.phoenixcontact.com/us/products/1788570>

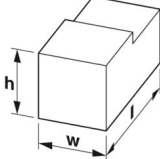
| | |
|---------------------|--|
| Dimensional drawing |  |
| Pitch | 5.08 mm |
| Width [w] | 41.8 mm |
| Height [h] | 17 mm |
| Length [l] | 20.5 mm |

Mechanical tests

Test for conductor damage and slackening

| | |
|---------------|---------------------|
| Specification | IEC 60999-1:1999-11 |
| Result | Test passed |

Pull-out test

| | |
|---|---|
| Specification | IEC 60999-1:1999-11 |
| Conductor cross-section/conductor type/tractive force setpoint/actual value | 0.2 mm ² / solid / > 10 N |
| | 0.2 mm ² / flexible / > 10 N |
| | 2.5 mm ² / solid / > 50 N |
| | 2.5 mm ² / flexible / > 50 N |

Insertion and withdrawal forces

| | |
|-------------------------------------|-------------|
| Result | Test passed |
| No. of cycles | 25 |
| Insertion strength per pos. approx. | 8 N |
| Withdraw strength per pos. approx. | 6 N |

Torque test

| | |
|---------------|---------------------|
| Specification | IEC 60999-1:1999-11 |
|---------------|---------------------|

Contact holder in insert

| | |
|---|------------------------|
| Specification | IEC 60512-15-1:2008-05 |
| Contact holder in insert Requirements >20 N | Test passed |

Resistance of inscriptions

| | |
|---------------|------------------------|
| Specification | IEC 60068-2-70:1995-12 |
| Result | Test passed |

Polarization and coding

| | |
|---------------|------------------------|
| Specification | IEC 60512-13-5:2006-02 |
| Result | Test passed |

Visual inspection

MVSTBU 2,5/ 6-GB-5,08 - PCB header



1788570

<https://www.phoenixcontact.com/us/products/1788570>

| | |
|---------------|-----------------------|
| Specification | IEC 60512-1-1:2002-02 |
| Result | Test passed |

Dimension check

| | |
|---------------|-----------------------|
| Specification | IEC 60512-1-2:2002-02 |
| Result | Test passed |

Electrical tests

Thermal test | Test group C

| | |
|----------------------------|-----------------------|
| Specification | IEC 60512-5-1:2002-02 |
| Tested number of positions | 20 |

Insulation resistance

| | |
|--|-----------------------|
| Specification | IEC 60512-3-1:2002-02 |
| Insulation resistance, neighboring positions | > 5 MΩ |

Air clearances and creepage distances |

| | |
|--|---------------------|
| Specification | IEC 60664-1:2007-04 |
| Insulating material group | I |
| Comparative tracking index (IEC 60112) | CTI 600 |
| Rated insulation voltage (III/3) | 320 V |
| Rated surge voltage (III/3) | 4 kV |
| minimum clearance value - non-homogenous field (III/3) | 3 mm |
| minimum creepage distance (III/3) | 4 mm |
| Rated insulation voltage (III/2) | 320 V |
| Rated surge voltage (III/2) | 4 kV |
| minimum clearance value - non-homogenous field (III/2) | 3 mm |
| minimum creepage distance (III/2) | 3 mm |
| Rated insulation voltage (II/2) | 630 V |
| Rated surge voltage (II/2) | 4 kV |
| minimum clearance value - non-homogenous field (II/2) | 3 mm |
| minimum creepage distance (II/2) | 3.2 mm |

Environmental and real-life conditions

Durability test

| | |
|--|-----------------------|
| Specification | IEC 60512-9-1:2010-03 |
| Impulse withstand voltage at sea level | 4.8 kV |
| Contact resistance R ₁ | 1.9 mΩ |
| Contact resistance R ₂ | 2.2 mΩ |
| Insertion/withdrawal cycles | 25 |
| Insulation resistance, neighboring positions | > 5 MΩ |

Climatic test

| | |
|------------------|---|
| Specification | ISO 6988:1985-02 |
| Corrosive stress | 0.2 dm ³ SO ₂ on 300 dm ³ /40 °C/1 cycle |

MVSTBU 2,5/ 6-GB-5,08 - PCB header



1788570

<https://www.phoenixcontact.com/us/products/1788570>

| | |
|-----------------------------------|--------------|
| Thermal stress | 100 °C/168 h |
| Power-frequency withstand voltage | 2.21 kV |

Vibration test

| | |
|------------------------|-----------------------------|
| Specification | IEC 60068-2-6:2007-12 |
| Frequency | 10 - 150 - 10 Hz |
| Sweep speed | 1 octave/min |
| Amplitude | 0.35 mm (10 Hz ... 60.1 Hz) |
| Acceleration | 5g (60.1 Hz ... 150 Hz) |
| Test duration per axis | 2.5 h |
| Test directions | X-, Y- and Z-axis |

Ambient conditions

| | |
|---|---|
| Ambient temperature (storage/transport) | -40 °C ... 70 °C |
| Relative humidity (storage/transport) | 30 % ... 70 % |
| Ambient temperature (assembly) | -5 °C ... 100 °C |
| Ambient temperature (operation) | -40 °C ... 100 °C (dependent on the derating curve) |

Ambient conditions

| | |
|---|---|
| Ambient temperature (operation) | -40 °C ... 100 °C (dependent on the derating curve) |
| Ambient temperature (storage/transport) | -40 °C ... 70 °C |
| Relative humidity (storage/transport) | 30 % ... 70 % |
| Ambient temperature (assembly) | -5 °C ... 100 °C |

Packaging specifications

| | |
|-------------------|---------------------|
| Type of packaging | packed in cardboard |
|-------------------|---------------------|

1788570

<https://www.phoenixcontact.com/us/products/1788570>

Drawings



Type: MSTB 2,5/...-ST-5,08 with MVSTBU 2,5/...-GB-5,08

Drilling plan/solder pad geometry



MVSTBU 2,5/ 6-GB-5,08 - PCB header



1788570

<https://www.phoenixcontact.com/us/products/1788570>

Approvals

To download certificates, visit the product detail page: <https://www.phoenixcontact.com/us/products/1788570>

|  CSA Approval ID: 13631 | | | | |
|--|-----------------------|-----------------------|-------------------|-----------------------------|
| | Nominal voltage U_N | Nominal current I_N | Cross section AWG | Cross section mm^2 |
| B | | | | |
| | 300 V | 10 A | 28 - 12 | - |
| D | | | | |
| | 300 V | 10 A | 28 - 12 | - |

|  cULus Recognized Approval ID: E60425-19931014 | | | | |
|---|-----------------------|-----------------------|-------------------|-----------------------------|
| | Nominal voltage U_N | Nominal current I_N | Cross section AWG | Cross section mm^2 |
| B | | | | |
| Screw connection | 250 V | 12 A | 30 - 12 | - |
| 2 conductors with the same cross-section | 250 V | 12 A | 24 - 16 | - |
| D | | | | |
| Screw connection | 300 V | 10 A | 30 - 12 | - |
| 2 conductors with the same cross-section | 300 V | 10 A | 24 - 16 | - |

|  VDE approval of drawings Approval ID: 40050694 | | | | |
|--|-----------------------|-----------------------|-------------------|-----------------------------|
| | Nominal voltage U_N | Nominal current I_N | Cross section AWG | Cross section mm^2 |
| keine | | | | |
| | 250 V | 12 A | - | - |

MVSTBU 2,5/ 6-GB-5,08 - PCB header



1788570

<https://www.phoenixcontact.com/us/products/1788570>

Classifications

ECLASS

| | |
|-------------|----------|
| ECLASS-13.0 | 27460202 |
| ECLASS-15.0 | 27460202 |

ETIM

| | |
|-----------|----------|
| ETIM 10.0 | EC002638 |
|-----------|----------|

UNSPSC

| | |
|-------------|----------|
| UNSPSC 21.0 | 39121400 |
|-------------|----------|

MVSTBU 2,5/ 6-GB-5,08 - PCB header



1788570

<https://www.phoenixcontact.com/us/products/1788570>

Environmental product compliance

EU RoHS

| | |
|---|--------------------|
| Fulfills EU RoHS substance requirements | Yes, No exemptions |
|---|--------------------|

China RoHS

| | |
|--|--|
| Environment friendly use period (EFUP) | EFUP-E |
| | No hazardous substances above the limits |

EU REACH SVHC

| | |
|-------------------------------------|----------------------------|
| REACH candidate substance (CAS No.) | No substance above 0.1 wt% |
|-------------------------------------|----------------------------|

Phoenix Contact 2026 © - all rights reserved
<https://www.phoenixcontact.com>

Phoenix Contact USA
586 Fulling Mill Road
Middletown, PA 17057, United States
(+717) 944-1300
info@phoenixcon.com