

# MCV 1,5/ 6-GF-3,5 P14 THR - PCB header



1780011

<https://www.phoenixcontact.com/us/products/1780011>

Please be informed that the data shown in this PDF document is generated from our online catalog. Please find the complete data in the user documentation. Our general terms of use for downloads are valid.

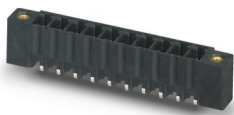

The figure shows a 10-position version of the product

PCB headers, nominal cross section: 1.5 mm<sup>2</sup>, color: black, nominal current: 8 A, rated voltage (III/2): 160 V, contact surface: Sn, contact connection type: Pin, number of potentials: 6, number of rows: 1, number of positions: 6, number of connections: 6, product range: MCV 1,5/..-GF-THR, pitch: 3.5 mm, mounting: THR soldering / wave soldering, pin layout: Linear pinning, solder pin [P]: 1.4 mm, number of solder pins per potential: 1, plug-in system: COMBICON MC 1,5, Pin connector pattern alignment: Standard, locking: Screw locking mechanism, mounting method: Threaded flange, type of packaging: packed in cardboard, For user information and design recommendations for through-hole reflow technology, go to: [Downloads](#)

## Your advantages

- Designed for integration into the SMT soldering process
- Screwable flange for superior mechanical stability
- Vertical connection enables multi-row arrangement on the PCB
- Maximum flexibility when it comes to device design – one header for connectors with different connection technologies

## Commercial data

Item number	1780011
Packing unit	100 pc
Minimum order quantity	50 pc
Sales key	AA02
Product key	AABTAD
GTIN	4046356532501
Weight per piece (including packing)	2.511 g
Weight per piece (excluding packing)	2.226 g
Customs tariff number	85366930
Country of origin	DE

# MCV 1,5/ 6-GF-3,5 P14 THR - PCB header



1780011

<https://www.phoenixcontact.com/us/products/1780011>

## Technical data

### Product properties

Product type	PCB headers
Product family	MCV 1,5/..-GF-THR
Product line	COMBICON Connectors S
Type	Component suitable for through hole reflow
Number of positions	6
Pitch	3.5 mm
Number of connections	6
Number of rows	1
Number of potentials	6
Mounting type	Threaded flange
Pin layout	Linear pinning
Solder pins per potential	1

### Electrical properties

#### Properties

Nominal current $I_N$	8 A
Nominal voltage $U_N$	160 V
Contact resistance	1.2 m $\Omega$
Rated voltage (III/3)	160 V
Rated surge voltage (III/3)	2.5 kV
Rated voltage (III/2)	160 V
Rated surge voltage (III/2)	2.5 kV
Rated voltage (II/2)	250 V
Rated surge voltage (II/2)	2.5 kV

### Mounting

Mounting type	THR soldering / wave soldering
Pin layout	Linear pinning

#### Flange

Tightening torque	0.3 Nm
-------------------	--------

#### Processing notes

Process	Reflow/wave soldering
Moisture Sensitive Level	MSL 1
Classification temperature $T_c$	260 °C
Solder cycles in the reflow	3

### Material specifications

#### Material data - contact

# MCV 1,5/ 6-GF-3,5 P14 THR - PCB header



1780011

<https://www.phoenixcontact.com/us/products/1780011>

Note	WEEE/RoHS-compliant, free of whiskers according to IEC 60068-2-82/JEDEC JESD 201
Contact material	Cu alloy
Surface characteristics	Tin-plated
Metal surface contact area (top layer)	Tin (3 µm - 5 µm Sn)
Metal surface contact area (middle layer)	Nickel (1.3 µm - 3 µm Ni)
Metal surface soldering area (top layer)	Tin (3 µm - 5 µm Sn)
Metal surface soldering area (middle layer)	Nickel (1.3 µm - 3 µm Ni)

## Material data - housing

Color (Housing)	black (9005)
Insulating material	LCP
Insulating material group	IIIa
CTI according to IEC 60112	175
Flammability rating according to UL 94	V0

## Dimensions

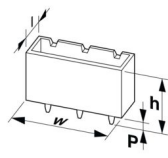
Dimensional drawing	
Pitch	3.5 mm
Width [w]	31.3 mm
Height [h]	10.6 mm
Length [l]	6.9 mm
Installed height	9.2 mm
Solder pin length [P]	1.4 mm
Pin dimensions	0.8 x 0.8 mm

## PCB design

Hole diameter	1.4 mm
---------------	--------

## Mechanical tests

### Visual inspection

Specification	IEC 60512-1-1:2002-02
Result	Test passed

### Dimension check

Specification	IEC 60512-1-2:2002-02
Result	Test passed

### Resistance of inscriptions

Specification	IEC 60068-2-70:1995-12
Result	Test passed

# MCV 1,5/ 6-GF-3,5 P14 THR - PCB header



1780011

<https://www.phoenixcontact.com/us/products/1780011>

## Polarization and coding

Specification	IEC 60512-13-5:2006-02
Result	Test passed

## Contact holder in insert

Specification	IEC 60512-15-1:2008-05
Contact holder in insert Requirements >20 N	Test passed

## Insertion and withdrawal forces

Specification	IEC 60512-13-2:2006-02
Result	Test passed
No. of cycles	25
Insertion strength per pos. approx.	6 N
Withdraw strength per pos. approx.	4 N

## Electrical tests

### Thermal test | Test group C

Specification	IEC 60512-5-1:2002-02
Tested number of positions	12

### Insulation resistance

Specification	IEC 60512-3-1:2002-02
Insulation resistance, neighboring positions	> 5 MΩ

### Air clearances and creepage distances |

Specification	IEC 60664-1:2007-04
Insulating material group	IIIa
Comparative tracking index (IEC 60112)	CTI 175
Rated insulation voltage (III/3)	160 V
Rated surge voltage (III/3)	2.5 kV
minimum clearance value - non-homogenous field (III/3)	1.5 mm
minimum creepage distance (III/3)	2.5 mm
Rated insulation voltage (III/2)	160 V
Rated surge voltage (III/2)	2.5 kV
minimum clearance value - non-homogenous field (III/2)	1.5 mm
minimum creepage distance (III/2)	1.6 mm
Rated insulation voltage (II/2)	250 V
Rated surge voltage (II/2)	2.5 kV
minimum clearance value - non-homogenous field (II/2)	1.5 mm
minimum creepage distance (II/2)	2.5 mm

## Environmental and real-life conditions

### Durability test

Specification	IEC 60512-9-1:2010-03
---------------	-----------------------

# MCV 1,5/ 6-GF-3,5 P14 THR - PCB header



1780011

<https://www.phoenixcontact.com/us/products/1780011>

Impulse withstand voltage at sea level	2.95 kV
Contact resistance R <sub>1</sub>	1.2 mΩ
Contact resistance R <sub>2</sub>	1.3 mΩ
Insertion/withdrawal cycles	25
Insulation resistance, neighboring positions	> 5 MΩ

## Climatic test

Specification	ISO 6988:1985-02
Corrosive stress	0.2 dm <sup>3</sup> SO <sub>2</sub> on 300 dm <sup>3</sup> /40 °C/1 cycle
Thermal stress	100 °C/168 h
Power-frequency withstand voltage	1.39 kV

## Vibration test

Specification	IEC 60068-2-6:2007-12
Frequency	10 - 150 - 10 Hz
Sweep speed	1 octave/min
Amplitude	0.35 mm (10 Hz ... 60.1 Hz)
Acceleration	5g (60.1 Hz ... 150 Hz)
Test duration per axis	2.5 h
Test directions	X-, Y- and Z-axis

## Shocks

Specification	IEC 60068-2-27:2008-02
Pulse shape	Semi-sinusoidal
Acceleration	30g
Shock duration	18 ms
Test directions	X-, Y- and Z-axis (pos. and neg.)

## Railway application: Shocks

Acceleration	30g
Shock duration	18 ms
Test directions	X-, Y- and Z-axis (pos. and neg.)

## Ambient conditions

Ambient temperature (storage/transport)	-40 °C ... 70 °C
Relative humidity (storage/transport)	30 % ... 70 %
Ambient temperature (assembly)	-5 °C ... 100 °C
Ambient temperature (operation)	-40 °C ... 100 °C (dependent on the derating curve)

## Packaging specifications

Type of packaging	packed in cardboard
-------------------	---------------------

## Drawings

Dimensional drawing

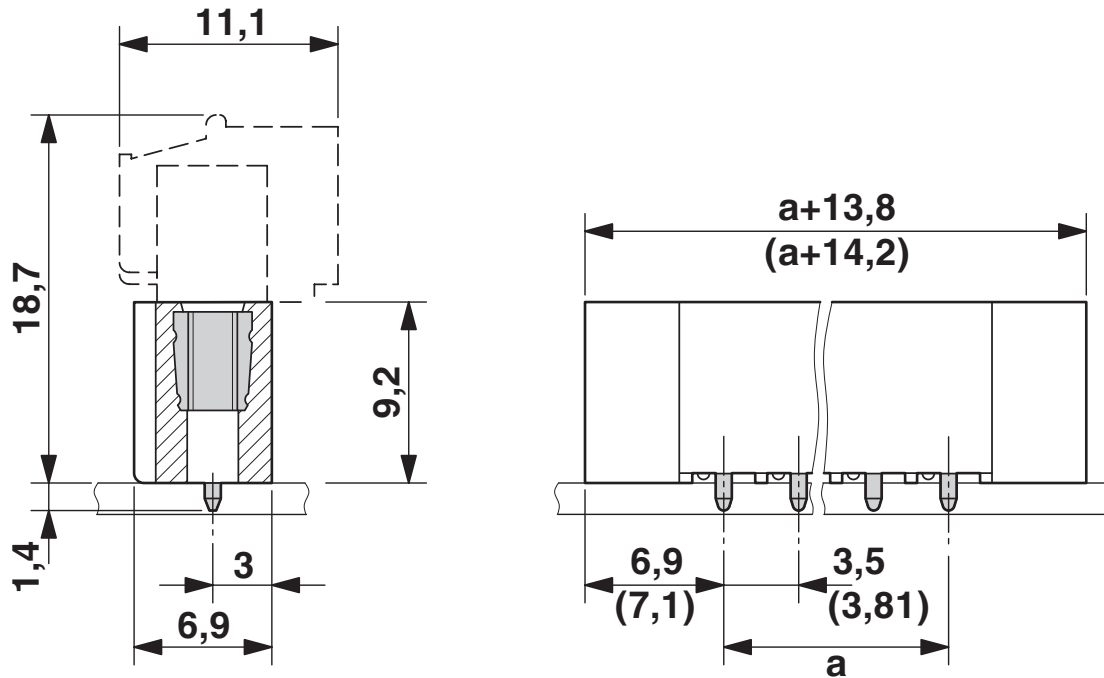

Diagram

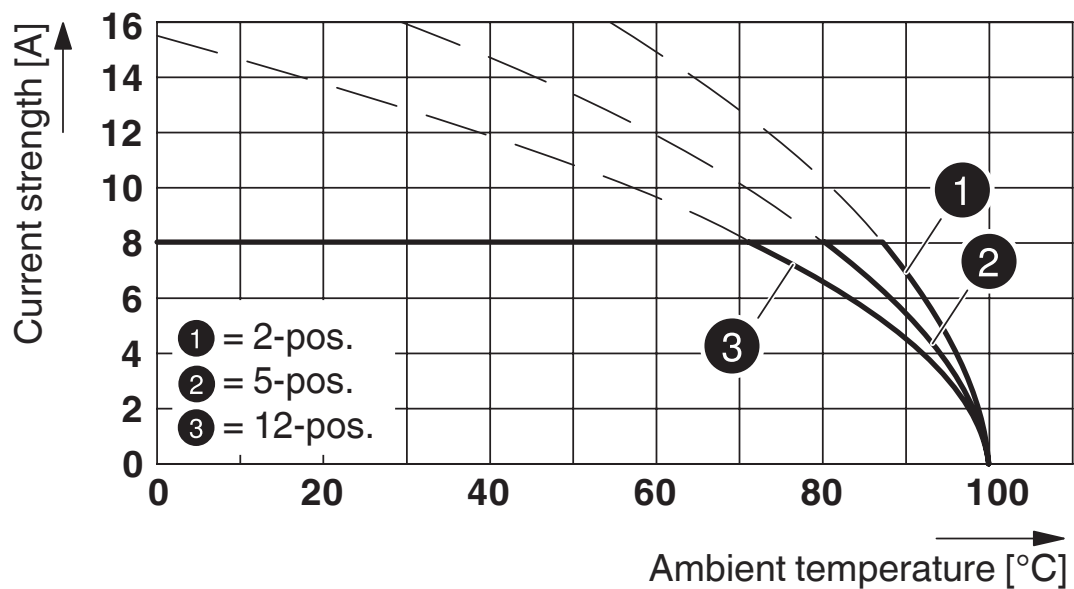

Type: MC 1,5/...-ST(F)-3,5 with MCV 1,5/...-G(F)-3,5 P... THR

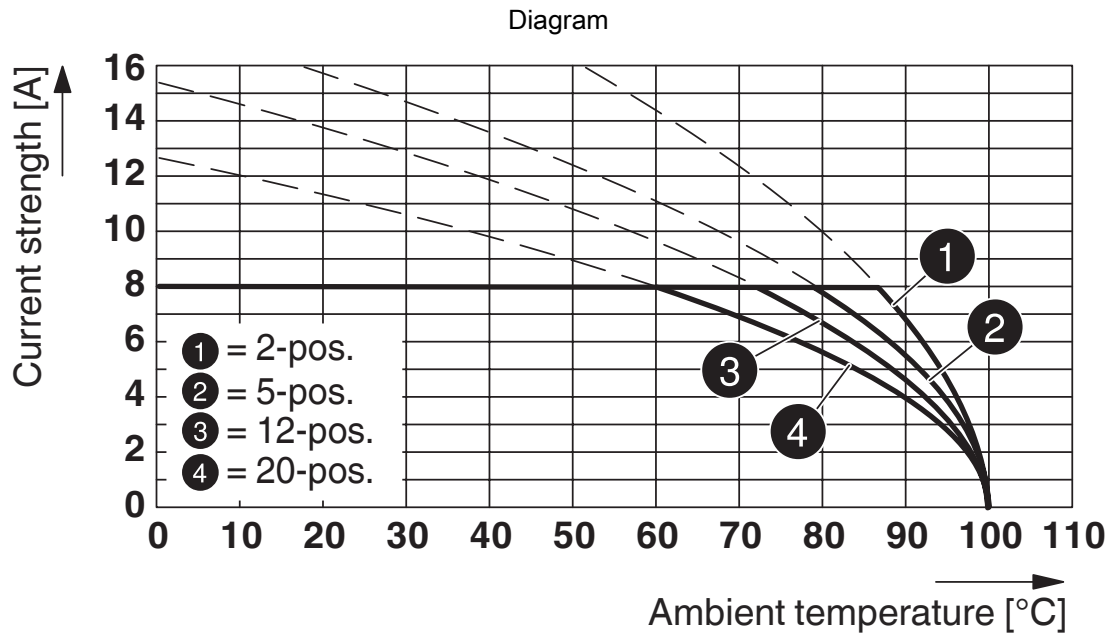

Type: FMC 1,5/...-STF-3,5 with MCV 1,5/...-GF-3,5 P... THR

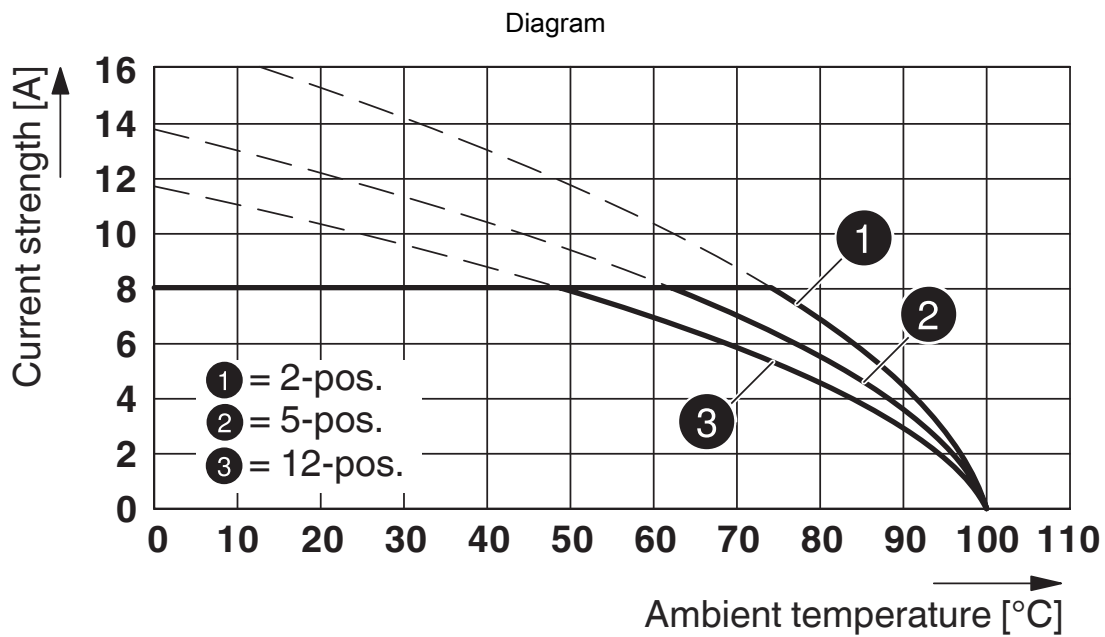

Type: MCV(W/R) 1,5/...-STF-3,81 with MCV 1,5/...-GF-3,5 P... THR

1780011

<https://www.phoenixcontact.com/us/products/1780011>



Type: FK-MCP 1,5/...-STF-3,5 with MCV 1,5/...-GF-3,5 P...THR



Type: TFMC 1,5/...-STF-3,5 with MCV 1,5/...-GF-3,5 P... THR

1780011

<https://www.phoenixcontact.com/us/products/1780011>

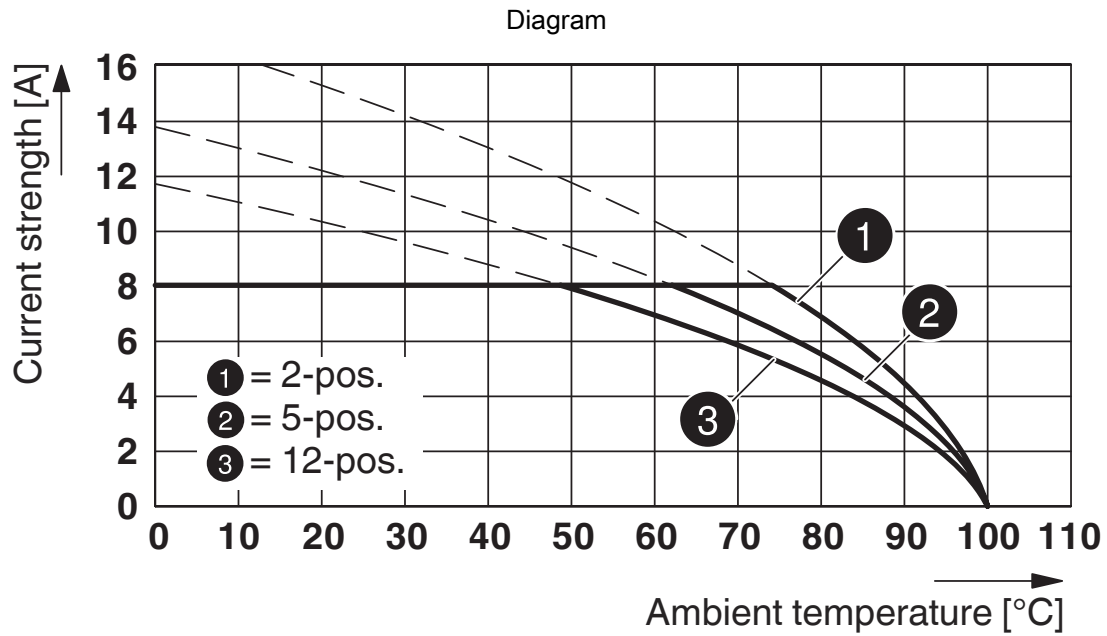

Type: MCV(W/R) 1,5/...-STF-3,81 with MCV 1,5/...-GF-3,5 P... THR

Drilling plan/solder pad geometry



# MCV 1,5/ 6-GF-3,5 P14 THR - PCB header



1780011

<https://www.phoenixcontact.com/us/products/1780011>

## Approvals

To download certificates, visit the product detail page: <https://www.phoenixcontact.com/us/products/1780011>

 <b>cULus Recognized</b> Approval ID: E60425-20110128				
	Nominal voltage $U_N$	Nominal current $I_N$	Cross section AWG	Cross section $\text{mm}^2$
B	300 V	8 A	-	-
D	300 V	8 A	-	-

 <b>VDE Zeichengenehmigung</b> Approval ID: 40011723				
	Nominal voltage $U_N$	Nominal current $I_N$	Cross section AWG	Cross section $\text{mm}^2$
keine	160 V	8 A	-	-

# MCV 1,5/ 6-GF-3,5 P14 THR - PCB header



1780011

<https://www.phoenixcontact.com/us/products/1780011>

## Classifications

### ECLASS

ECLASS-13.0	27460201
ECLASS-15.0	27460201

### ETIM

ETIM 10.0	EC002637
-----------	----------

### UNSPSC

UNSPSC 21.0	39121400
-------------	----------

# MCV 1,5/ 6-GF-3,5 P14 THR - PCB header



1780011

<https://www.phoenixcontact.com/us/products/1780011>

## Environmental product compliance

### EU RoHS

Fulfills EU RoHS substance requirements	Yes, No exemptions
---	--------------------

### China RoHS

Environment friendly use period (EFUP)	EFUP-E
	No hazardous substances above the limits

### EU REACH SVHC

REACH candidate substance (CAS No.)	No substance above 0.1 wt%
-------------------------------------	----------------------------

Phoenix Contact 2026 © - all rights reserved  
<https://www.phoenixcontact.com>

Phoenix Contact USA  
586 Fulling Mill Road  
Middletown, PA 17057, United States  
(+717) 944-1300  
[info@phoenixcon.com](mailto:info@phoenixcon.com)