

# FRONT-MSTB 2,5/14-ST - PCB connector



1779534

<https://www.phoenixcontact.com/us/products/1779534>

Please be informed that the data shown in this PDF document is generated from our online catalog. Please find the complete data in the user documentation. Our general terms of use for downloads are valid.

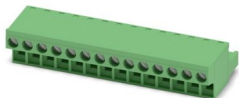

PCB connector, nominal cross section: 2.5 mm<sup>2</sup>, color: green, nominal current: 12 A, rated voltage (III/2): 320 V, contact surface: Sn, contact connection type: Socket, number of potentials: 14, number of rows: 1, number of positions: 14, number of connections: 14, product range: FRONT-MSTB 2,5/..-ST, pitch: 5 mm, connection method: Front screw connection, screw head form: L Slotted, conductor/PCB connection direction: 0 °, locking clip: - Locking clip, plug-in system: COMBICON MSTB 2,5, locking: without, mounting method: without, type of packaging: packed in cardboard

## Your advantages

- Well-known connection principle allows worldwide use
- Optimized for tight installation situations: operation and conductor connection from one direction
- Low temperature rise, thanks to maximum contact force
- Allows connection of two conductors

## Commercial data

Item number	1779534
Packing unit	50 pc
Minimum order quantity	50 pc
Note	Made to order (non-returnable)
Sales key	AA03
Product key	AACAAA
GTIN	4017918040222
Weight per piece (including packing)	44.8 g
Weight per piece (excluding packing)	43.87 g
Customs tariff number	85366990
Country of origin	DE

# FRONT-MSTB 2,5/14-ST - PCB connector



1779534

<https://www.phoenixcontact.com/us/products/1779534>

## Technical data

### Product properties

Product type	PCB connector
Product family	FRONT-MSTB 2,5/..-ST
Product line	COMBICON Connectors M
Type	Standard
Number of positions	14
Pitch	5 mm
Number of connections	14
Number of rows	1
Number of potentials	14
Mounting type	without

### Electrical properties

#### Properties

Nominal current $I_N$	12 A
Nominal voltage $U_N$	320 V
Contact resistance	1.7 m $\Omega$
Rated voltage (III/3)	250 V
Rated surge voltage (III/3)	4 kV
Rated voltage (III/2)	320 V
Rated surge voltage (III/2)	4 kV
Rated voltage (II/2)	630 V
Rated surge voltage (II/2)	4 kV

### Connection data

#### Connection technology

Type	Standard
Connector system	COMBICON MSTB 2,5
Nominal cross section	2.5 mm <sup>2</sup>
Contact connection type	Socket

#### Interlock

Locking type	without
Mounting type	without

#### Conductor connection

Connection method	Front screw connection
Conductor/PCB connection direction	0 °
Conductor cross-section rigid	0.34 mm <sup>2</sup> ... 2.5 mm <sup>2</sup>
Conductor cross-section flexible	0.2 mm <sup>2</sup> ... 2.5 mm <sup>2</sup>
Conductor cross-section AWG	24 ... 12

# FRONT-MSTB 2,5/14-ST - PCB connector



1779534

<https://www.phoenixcontact.com/us/products/1779534>

Conductor cross-section, flexible, with ferrule, without plastic sleeve	0.25 mm <sup>2</sup> ... 2.5 mm <sup>2</sup>
Conductor cross-section, flexible, with ferrule, with plastic sleeve	0.25 mm <sup>2</sup> ... 2.5 mm <sup>2</sup>
2 conductors with same cross section, rigid	0.2 mm <sup>2</sup> ... 1.5 mm <sup>2</sup>
2 conductors with same cross section, flexible	0.2 mm <sup>2</sup> ... 1.5 mm <sup>2</sup>
2 conductors with same cross section, flexible, with ferrule without plastic sleeve	0.25 mm <sup>2</sup> ... 1 mm <sup>2</sup>
2 conductors with the same cross section, flexible, with TWIN ferrule with plastic sleeve	0.5 mm <sup>2</sup> ... 1 mm <sup>2</sup>
Cylindrical gauge a x b / diameter	2.8 mm x 2.0 mm / 2.4 mm
Stripping length	10 mm
Drive form screw head	Slotted (L)
Tightening torque	0.5 Nm ... 0.6 Nm

## Specifications for ferrules without insulating collar

recommended crimping tool	1212034 CRIMPFOX 6
---------------------------	--------------------

## Specifications for ferrules with insulating collar

recommended crimping tool	1212034 CRIMPFOX 6
---------------------------	--------------------

## Material specifications

### Material data - contact

Note	WEEE/RoHS-compliant, free of whiskers according to IEC 60068-2-82/JEDEC JESD 201
Contact material	Cu alloy
Surface characteristics	hot-dip tin-plated
Metal surface terminal point (top layer)	Tin (4 µm - 8 µm Sn)
Metal surface contact area (top layer)	Tin (4 µm - 8 µm Sn)

### Material data - housing

Color (Housing)	green (6021)
Insulating material	PA
Insulating material group	I
CTI according to IEC 60112	600
Flammability rating according to UL 94	V0
Glow wire flammability index GWFI according to EN 60695-2-12	850
Glow wire ignition temperature GWIT according to EN 60695-2-13	775
Temperature for the ball pressure test according to EN 60695-10-2	125 °C

## Dimensions

# FRONT-MSTB 2,5/14-ST - PCB connector



1779534

<https://www.phoenixcontact.com/us/products/1779534>

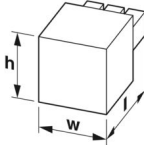
Dimensional drawing		
Pitch		5 mm
Width [w]		70 mm
Height [h]		15 mm
Length [l]		27.2 mm

## Notes

Notes on operation	In accordance with IEC 61984, COMBICON connectors have no switching power (COC). During designated use, they must not be plugged in or disconnected when carrying voltage or under load.
--------------------	--

## Mechanical tests

### Test for conductor damage and slackening

Specification	IEC 60999-1:1999-11
Result	Test passed

### Pull-out test

Specification	IEC 60999-1:1999-11
Conductor cross-section/conductor type/tractive force setpoint/actual value	0.34 mm <sup>2</sup> / solid / > 15 N
	0.2 mm <sup>2</sup> / flexible / > 10 N
	2.5 mm <sup>2</sup> / solid / > 50 N
	2.5 mm <sup>2</sup> / flexible / > 50 N

### Insertion and withdrawal forces

Specification	IEC 60512-13-2:2006-02
Result	Test passed
No. of cycles	25
Insertion strength per pos. approx.	8 N
Withdraw strength per pos. approx.	6 N

### Torque test

Specification	IEC 60999-1:1999-11
---------------	---------------------

### Resistance of inscriptions

Specification	IEC 60068-2-70:1995-12
Result	Test passed

### Polarization and coding

Specification	IEC 60512-13-5:2006-02
Result	Test passed

### Visual inspection

# FRONT-MSTB 2,5/14-ST - PCB connector



1779534

<https://www.phoenixcontact.com/us/products/1779534>

Specification	IEC 60512-1-1:2002-02
Result	Test passed

## Dimension check

Specification	IEC 60512-1-2:2002-02
Result	Test passed

## Environmental and real-life conditions

### Durability test

Specification	IEC 60512-9-1:2010-03
Impulse withstand voltage at sea level	4.8 kV
Contact resistance $R_1$	1.7 m $\Omega$
Contact resistance $R_2$	1.8 m $\Omega$
Insertion/withdrawal cycles	25
Insulation resistance, neighboring positions	> 5 M $\Omega$

### Climatic test

Specification	ISO 6988:1985-02
Corrosive stress	0.2 dm <sup>3</sup> SO <sub>2</sub> on 300 dm <sup>3</sup> /40 °C/1 cycle
Thermal stress	100 °C/168 h
Power-frequency withstand voltage	2.21 kV

### Vibration test

Specification	IEC 60068-2-6:2007-12
Frequency	10 - 150 - 10 Hz
Sweep speed	1 octave/min
Amplitude	0.35 mm (10 Hz ... 60.1 Hz)
Acceleration	5g (60.1 Hz ... 150 Hz)
Test duration per axis	2.5 h
Test directions	X-, Y- and Z-axis

### Ambient conditions

Ambient temperature (storage/transport)	-40 °C ... 70 °C
Relative humidity (storage/transport)	30 % ... 70 %
Ambient temperature (assembly)	-5 °C ... 100 °C
Ambient temperature (operation)	-40 °C ... 100 °C (dependent on the derating curve)

## Electrical tests

### Thermal test | Test group C

Specification	IEC 60512-5-1:2002-02
Tested number of positions	24

### Insulation resistance

Specification	IEC 60512-3-1:2002-02
Insulation resistance, neighboring positions	> 5 M $\Omega$

# FRONT-MSTB 2,5/14-ST - PCB connector



1779534

<https://www.phoenixcontact.com/us/products/1779534>

## Air clearances and creepage distances |

Specification	IEC 60664-1:2007-04
Insulating material group	I
Comparative tracking index (IEC 60112)	CTI 600
Rated insulation voltage (III/3)	250 V
Rated surge voltage (III/3)	4 kV
minimum clearance value - non-homogenous field (III/3)	3 mm
minimum creepage distance (III/3)	3.2 mm
Rated insulation voltage (III/2)	320 V
Rated surge voltage (III/2)	4 kV
minimum clearance value - non-homogenous field (III/2)	3 mm
minimum creepage distance (III/2)	3 mm
Rated insulation voltage (II/2)	630 V
Rated surge voltage (II/2)	4 kV
minimum clearance value - non-homogenous field (II/2)	3 mm
minimum creepage distance (II/2)	3.2 mm

## Packaging specifications

Type of packaging	packed in cardboard
-------------------	---------------------

1779534

<https://www.phoenixcontact.com/us/products/1779534>

## Drawings

Diagram

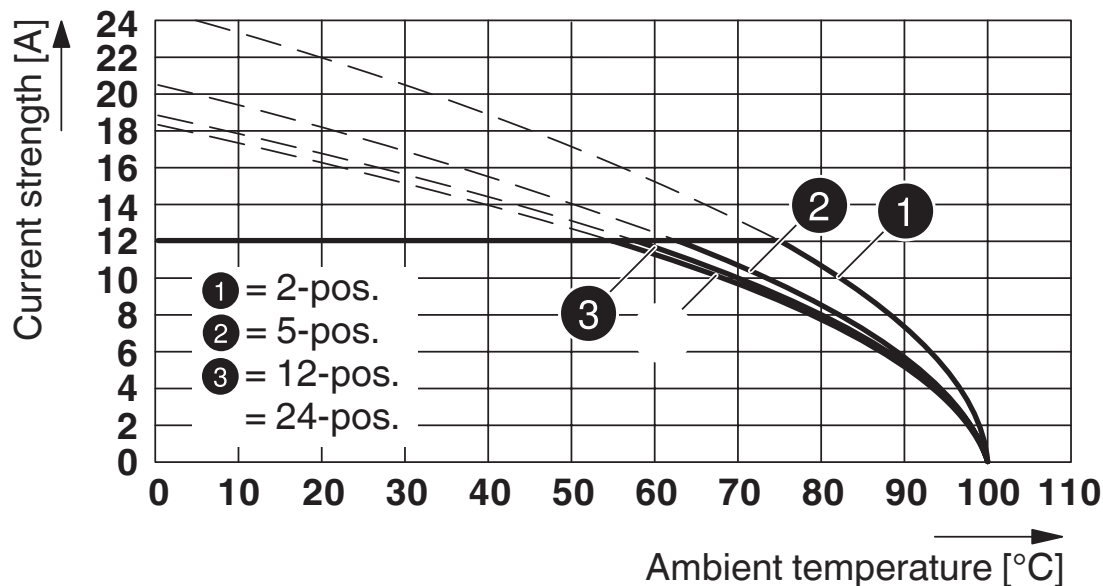

Type: FRONT-MSTB 2,5/...-ST with MSTB 2,5/...-G

Diagram

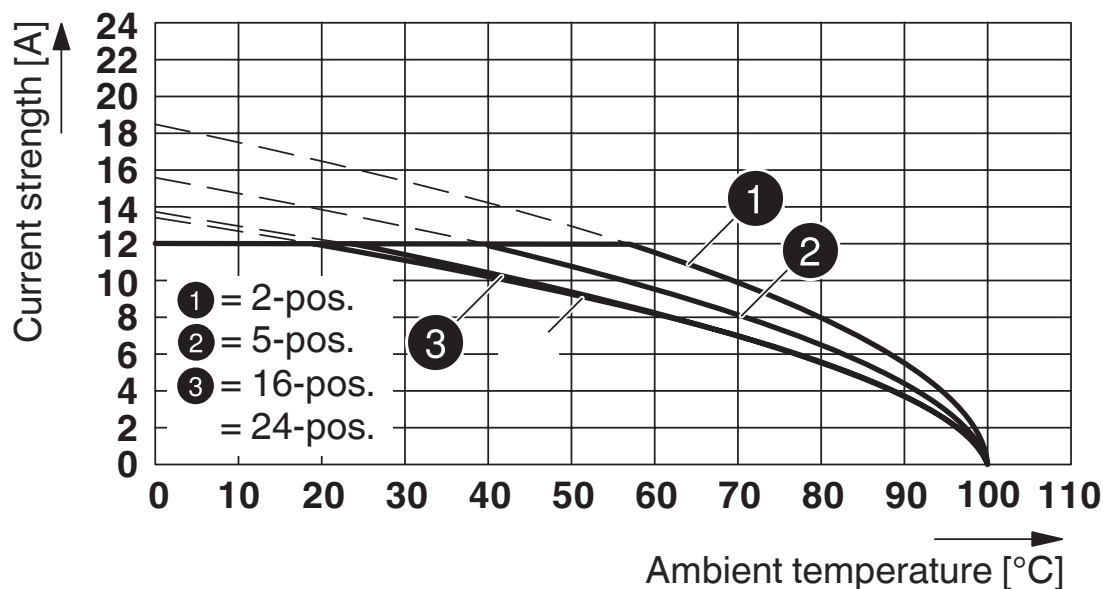

Type: FRONT-MSTB 2,5/...-ST with MSTBV 2,5/...-G

1779534

<https://www.phoenixcontact.com/us/products/1779534>



Type: FRONT-MSTB 2,5/...-ST with MDSTB 2,5/...-G



Type: FRONT-MSTB 2,5/...-ST with MDSTBW 2,5/...-G



Type: FRONT-MSTB 2,5/...-ST with MDSTBA 2,5/...-G



Type: FRONT-MSTB 2,5/...-ST with MDSTBV 2,5/...-G

1779534

<https://www.phoenixcontact.com/us/products/1779534>



Type: FRONT-MSTB 2,5/...-ST with MDSTBVA 2,5/...-G



Type: FRONT-MSTB 2,5/...-ST with SMSTB 2,5/...-G

1779534

<https://www.phoenixcontact.com/us/products/1779534>



Type: FRONT-MSTB 2,5/...-ST with SMSTBA 2,5/...-G



Type: FRONT-MSTB 2,5/...-ST with MSTBW 2,5/...-G

1779534

<https://www.phoenixcontact.com/us/products/1779534>



Type: FRONT-MSTB 2,5/...-ST with FKIC 2,5/...-ST



Type: FRONT-MSTB 2,5/...-ST with MSTBO 2,5/...-G1R

1779534

<https://www.phoenixcontact.com/us/products/1779534>



Type: FRONT-MSTB 2,5/...-ST with MSTBO 2,5/...-G1L



Type: FRONT-MSTB 2,5/...-ST with MDSTBV 2,5/...-G1

# FRONT-MSTB 2,5/14-ST - PCB connector



1779534

<https://www.phoenixcontact.com/us/products/1779534>

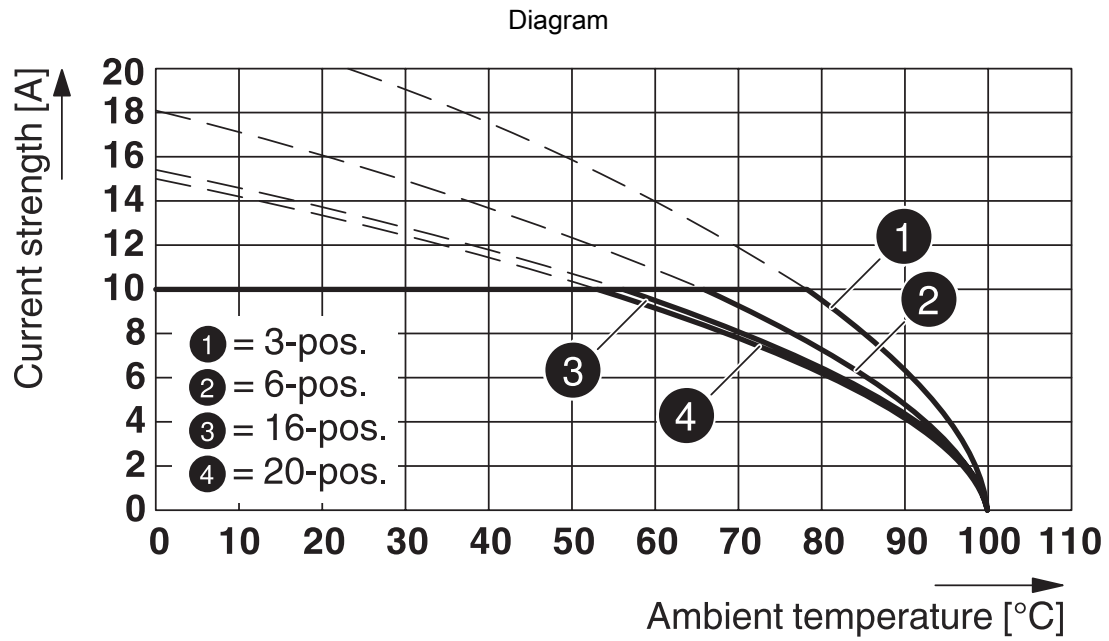

Type: FRONT-MSTB 2,5/...-ST with MDSTB 2,5/...-G1

# FRONT-MSTB 2,5/14-ST - PCB connector



1779534

<https://www.phoenixcontact.com/us/products/1779534>

## Approvals

To download certificates, visit the product detail page: <https://www.phoenixcontact.com/us/products/1779534>

 <b>CSA</b> Approval ID: 2406780				
	Nominal voltage $U_N$	Nominal current $I_N$	Cross section AWG	Cross section $\text{mm}^2$
B	300 V	15 A	22 - 12	-
D	300 V	10 A	22 - 12	-

 <b>cULus Recognized</b> Approval ID: E60425-19931011				
	Nominal voltage $U_N$	Nominal current $I_N$	Cross section AWG	Cross section $\text{mm}^2$
B	300 V	15 A	30 - 12	-
D	300 V	10 A	30 - 12	-

 <b>VDE Zeichengenehmigung</b> Approval ID: 40004701				
	Nominal voltage $U_N$	Nominal current $I_N$	Cross section AWG	Cross section $\text{mm}^2$
keine	250 V	12 A	-	0.34 - 2.5

# FRONT-MSTB 2,5/14-ST - PCB connector



1779534

<https://www.phoenixcontact.com/us/products/1779534>

## Classifications

### ECLASS

ECLASS-13.0	27460202
ECLASS-15.0	27460202

### ETIM

ETIM 10.0	EC002638
-----------	----------

### UNSPSC

UNSPSC 21.0	39121400
-------------	----------

# FRONT-MSTB 2,5/14-ST - PCB connector



1779534

<https://www.phoenixcontact.com/us/products/1779534>

## Environmental product compliance

### EU RoHS

Fulfills EU RoHS substance requirements	Yes, No exemptions
---	--------------------

### China RoHS

Environment friendly use period (EFUP)	EFUP-E
	No hazardous substances above the limits

### EU REACH SVHC

REACH candidate substance (CAS No.)	No substance above 0.1 wt%
-------------------------------------	----------------------------

Phoenix Contact 2026 © - all rights reserved  
<https://www.phoenixcontact.com>

Phoenix Contact USA  
586 Fulling Mill Road  
Middletown, PA 17057, United States  
(+717) 944-1300  
[info@phoenixcon.com](mailto:info@phoenixcon.com)