

PC 5/ 5-ST1-7,62 - PCB connector

1777752

<https://www.phoenixcontact.com/us/products/1777752>

Please be informed that the data shown in this PDF document is generated from our online catalog. Please find the complete data in the user documentation. Our general terms of use for downloads are valid.

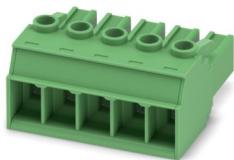

PCB connector, nominal cross section: 6 mm², color: green, nominal current: 32 A, rated voltage (III/2): 1000 V, contact surface: Sn, contact connection type: Socket, number of potentials: 5, number of rows: 1, number of positions: 5, number of connections: 5, product range: PC 5/-ST1, pitch: 7.62 mm, connection method: Screw connection with tension sleeve, screw head form: H1L Slotted Phillips recess, conductor/PCB connection direction: 0 °, locking clip: - Locking clip, plug-in system: COMBICON PC 5, locking: without, mounting method: without, type of packaging: packed in cardboard

Your advantages

- Well-known connection principle allows worldwide use
- Low temperature rise, thanks to maximum contact force
- Allows connection of two conductors
- Integrated double steel spring provides additional safety in the event of temperature and power fluctuations
- 600 V UL approval in the smallest of dimensions

Commercial data

| | |
|--------------------------------------|---------------|
| Item number | 1777752 |
| Packing unit | 50 pc |
| Minimum order quantity | 50 pc |
| Sales key | AA04 |
| Product key | AADABA |
| GTIN | 4046356522892 |
| Weight per piece (including packing) | 22.403 g |
| Weight per piece (excluding packing) | 22.363 g |
| Customs tariff number | 85366990 |
| Country of origin | DE |

PC 5/ 5-ST1-7,62 - PCB connector



1777752

<https://www.phoenixcontact.com/us/products/1777752>

Technical data

Product properties

| | |
|-----------------------|-----------------------|
| Product type | PCB connector |
| Product family | PC 5/...-ST1 |
| Product line | COMBICON Connectors L |
| Type | Standard |
| Number of positions | 5 |
| Pitch | 7.62 mm |
| Number of connections | 5 |
| Number of rows | 1 |
| Number of potentials | 5 |
| Mounting type | without |

Electrical properties

Properties

| | |
|-----------------------------|--------|
| Nominal current I_N | 32 A |
| Nominal voltage U_N | 1000 V |
| Contact resistance | 0.4 mΩ |
| Rated voltage (III/3) | 1000 V |
| Rated surge voltage (III/3) | 8 kV |
| Rated voltage (III/2) | 1000 V |
| Rated surge voltage (III/2) | 8 kV |
| Rated voltage (II/2) | 1000 V |
| Rated surge voltage (II/2) | 6 kV |

Connection data

Connection technology

| | |
|-------------------------|-------------------|
| Type | Standard |
| Connector system | COMBICON PC 5 |
| Nominal cross section | 6 mm ² |
| Contact connection type | Socket |

Interlock

| | |
|---------------|---------|
| Locking type | without |
| Mounting type | without |

Conductor connection

| | |
|------------------------------------|--|
| Connection method | Screw connection with tension sleeve |
| Conductor/PCB connection direction | 0 ° |
| Conductor cross-section rigid | 0.2 mm ² ... 10 mm ² |
| Conductor cross-section flexible | 0.2 mm ² ... 6 mm ² |
| Conductor cross-section AWG | 24 ... 10 |

PC 5/ 5-ST1-7,62 - PCB connector

1777752

<https://www.phoenixcontact.com/us/products/1777752>

| | |
|---|--|
| Conductor cross-section, flexible, with ferrule, without plastic sleeve | 0.25 mm ² ... 6 mm ² |
| Conductor cross-section, flexible, with ferrule, with plastic sleeve | 0.25 mm ² ... 4 mm ² |
| 2 conductors with same cross section, rigid | 0.2 mm ² ... 2.5 mm ² |
| 2 conductors with same cross section, flexible | 0.2 mm ² ... 4 mm ² |
| 2 conductors with same cross section, flexible, with ferrule without plastic sleeve | 0.25 mm ² ... 1.5 mm ² |
| 2 conductors with the same cross section, flexible, with TWIN ferrule with plastic sleeve | 0.25 mm ² ... 2.5 mm ² |
| Cylindrical gauge a x b / diameter | 3.6 mm x 3.1 mm / 3.4 mm |
| Stripping length | 10 mm |
| Drive form screw head | Slotted Phillips recess (H1L) |
| Tightening torque | 0.5 Nm ... 0.8 Nm ($\leq 4 \text{ mm}^2$ is 0.5 Nm to 0.6 Nm, $> 4 \text{ mm}^2$ is 0.7 Nm to 0.8 Nm) |

Material specifications

Material data - contact

| | |
|--|--|
| Note | WEEE/RoHS-compliant, free of whiskers according to IEC 60068-2-82/JEDEC JESD 201 |
| Contact material | Cu alloy |
| Surface characteristics | hot-dip tin-plated |
| Metal surface terminal point (top layer) | Tin (4 μm - 8 μm Sn) |
| Metal surface contact area (top layer) | Tin (4 μm - 8 μm Sn) |

Material data - housing

| | |
|---|--------------|
| Color (Housing) | green (6021) |
| Insulating material | PA |
| Insulating material group | I |
| CTI according to IEC 60112 | 600 |
| Flammability rating according to UL 94 | V0 |
| Glow wire flammability index GWFI according to EN 60695-2-12 | 850 |
| Glow wire ignition temperature GWIT according to EN 60695-2-13 | 775 |
| Temperature for the ball pressure test according to EN 60695-10-2 | 125 °C |

Dimensions

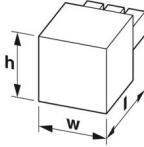
| | |
|---------------------|--|
| Dimensional drawing |  |
| Pitch | 7.62 mm |
| Width [w] | 38.05 mm |
| Height [h] | 19.7 mm |

PC 5/ 5-ST1-7,62 - PCB connector



1777752

<https://www.phoenixcontact.com/us/products/1777752>

| | |
|------------|----------|
| Length [l] | 35.25 mm |
|------------|----------|

Notes

| | |
|--------------------|--|
| Notes on operation | In accordance with IEC 61984, COMBICON connectors have no switching power (COC). During designated use, they must not be plugged in or disconnected when carrying voltage or under load. |
|--------------------|--|

Mechanical tests

Test for conductor damage and slackening

| | |
|---------------|---------------------|
| Specification | IEC 60999-1:1999-11 |
| Result | Test passed |

Pull-out test

| | |
|---|---|
| Specification | IEC 60999-1:1999-11 |
| Conductor cross-section/conductor type/tractive force setpoint/actual value | 0.2 mm ² / solid / > 10 N |
| | 0.2 mm ² / flexible / > 10 N |
| | 10 mm ² / solid / > 90 N |
| | 6 mm ² / flexible / > 80 N |
| | 6 mm ² / solid / > 80 N |
| 4 mm ² / flexible / > 60 N | |

Insertion and withdrawal forces

| | |
|-------------------------------------|------------------------|
| Specification | IEC 60512-13-2:2006-02 |
| Result | Test passed |
| No. of cycles | 50 |
| Insertion strength per pos. approx. | 8 N |
| Withdraw strength per pos. approx. | 6.5 N |

Torque test

| | |
|---------------|---------------------|
| Specification | IEC 60999-1:1999-11 |
|---------------|---------------------|

Resistance of inscriptions

| | |
|---------------|------------------------|
| Specification | IEC 60068-2-70:1995-12 |
| Result | Test passed |

Polarization and coding

| | |
|---------------|------------------------|
| Specification | IEC 60512-13-5:2006-02 |
| Result | Test passed |

Visual inspection

| | |
|---------------|-----------------------|
| Specification | IEC 60512-1-1:2002-02 |
| Result | Test passed |

Dimension check

| | |
|---------------|-----------------------|
| Specification | IEC 60512-1-2:2002-02 |
| Result | Test passed |

Environmental and real-life conditions

PC 5/ 5-ST1-7,62 - PCB connector



1777752

<https://www.phoenixcontact.com/us/products/1777752>

Durability test

| | |
|--|---------------------|
| Specification | IEC 60512-5:1992-08 |
| Impulse withstand voltage at sea level | 7.3 kV |
| Contact resistance R ₁ | 0.4 mΩ |
| Contact resistance R ₂ | 0.5 mΩ |
| Insertion/withdrawal cycles | 50 |

Climatic test

| | |
|-----------------------------------|---|
| Specification | ISO 6988:1985-02 |
| Corrosive stress | 0.2 dm ³ SO ₂ on 300 dm ³ /40 °C/1 cycle |
| Thermal stress | 100 °C/168 h |
| Power-frequency withstand voltage | 3.31 kV |

Vibration test

| | |
|------------------------|-----------------------------|
| Specification | IEC 60068-2-6:2007-12 |
| Frequency | 10 - 150 - 10 Hz |
| Sweep speed | 1 octave/min |
| Amplitude | 0.35 mm (10 Hz ... 60.1 Hz) |
| Acceleration | 5g (60.1 Hz ... 150 Hz) |
| Test duration per axis | 2.5 h |
| Test directions | X-, Y- and Z-axis |

Ambient conditions

| | |
|---|---|
| Ambient temperature (storage/transport) | -40 °C ... 70 °C |
| Relative humidity (storage/transport) | 30 % ... 70 % |
| Ambient temperature (assembly) | -5 °C ... 100 °C |
| Ambient temperature (operation) | -40 °C ... 100 °C (dependent on the derating curve) |

Electrical tests

Thermal test | Test group C

| | |
|----------------------------|-----------------------|
| Specification | IEC 60512-5-1:2002-02 |
| Tested number of positions | 12 |

Insulation resistance

| | |
|--|-----------------------|
| Specification | IEC 60512-3-1:2002-02 |
| Insulation resistance, neighboring positions | >10 ¹² Ω |

Air clearances and creepage distances |

| | |
|--|---------------------|
| Specification | IEC 60664-1:2007-04 |
| Insulating material group | I |
| Comparative tracking index (IEC 60112) | CTI 600 |
| Rated insulation voltage (III/3) | 1000 V |
| Rated surge voltage (III/3) | 8 kV |
| minimum clearance value - non-homogenous field (III/3) | 8 mm |
| minimum creepage distance (III/3) | 12.5 mm |

PC 5/ 5-ST1-7,62 - PCB connector



1777752

<https://www.phoenixcontact.com/us/products/1777752>

| | |
|--|--------|
| Rated insulation voltage (III/2) | 1000 V |
| Rated surge voltage (III/2) | 8 kV |
| minimum clearance value - non-homogenous field (III/2) | 8 mm |
| minimum creepage distance (III/2) | 8 mm |
| Rated insulation voltage (II/2) | 1000 V |
| Rated surge voltage (II/2) | 6 kV |
| minimum clearance value - non-homogenous field (II/2) | 5.5 mm |
| minimum creepage distance (II/2) | 5.5 mm |

Packaging specifications

| | |
|-------------------|---------------------|
| Type of packaging | packed in cardboard |
|-------------------|---------------------|

Drawings

Dimensional drawing

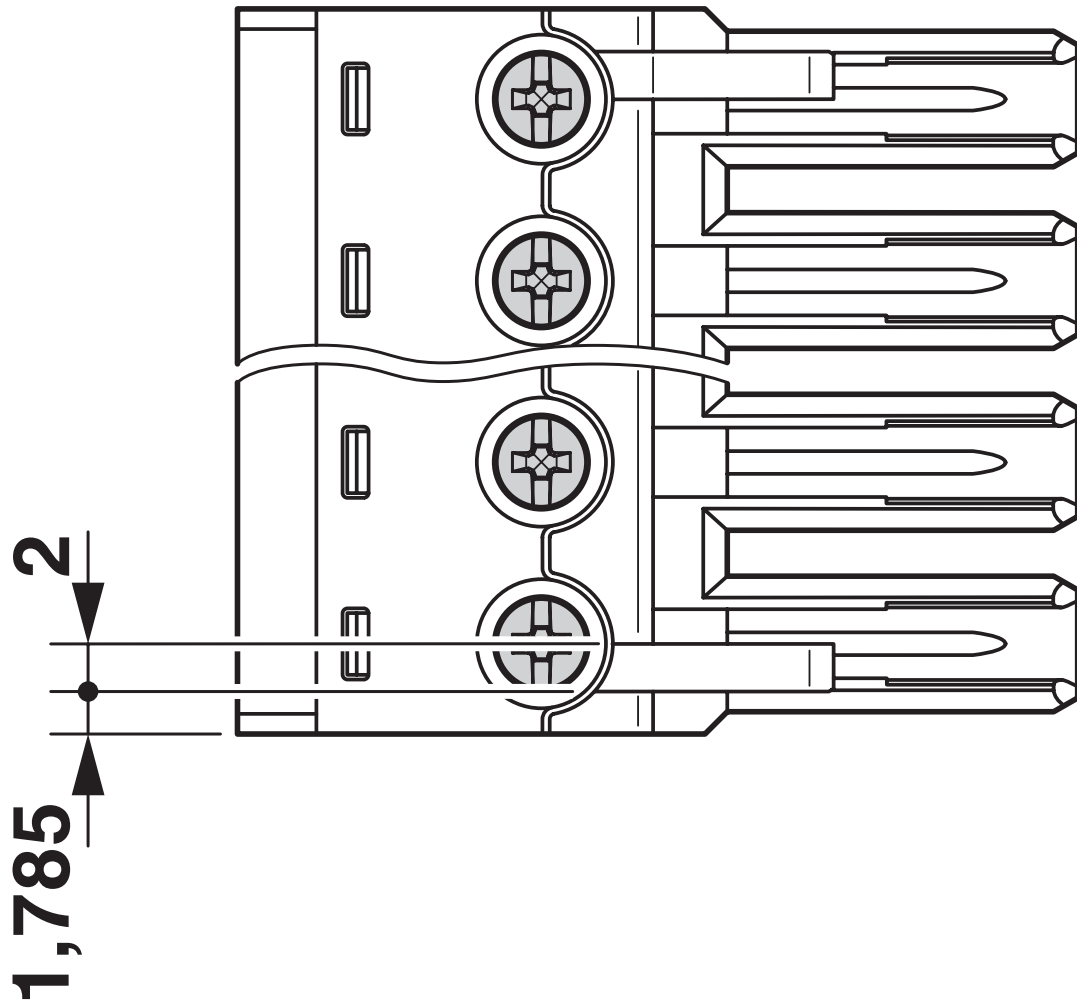

177752

<https://www.phoenixcontact.com/us/products/177752>



Type: PC 5/...-ST1-7,62 with PC 5/...-G-7,62
 Conductor cross-section: 6 mm²



Type: PC 5/...-ST1-7,62 with PC 5/...-G-7,62
 Conductor cross-section: 10 mm²

PC 5/ 5-ST1-7,62 - PCB connector



177752

<https://www.phoenixcontact.com/us/products/177752>

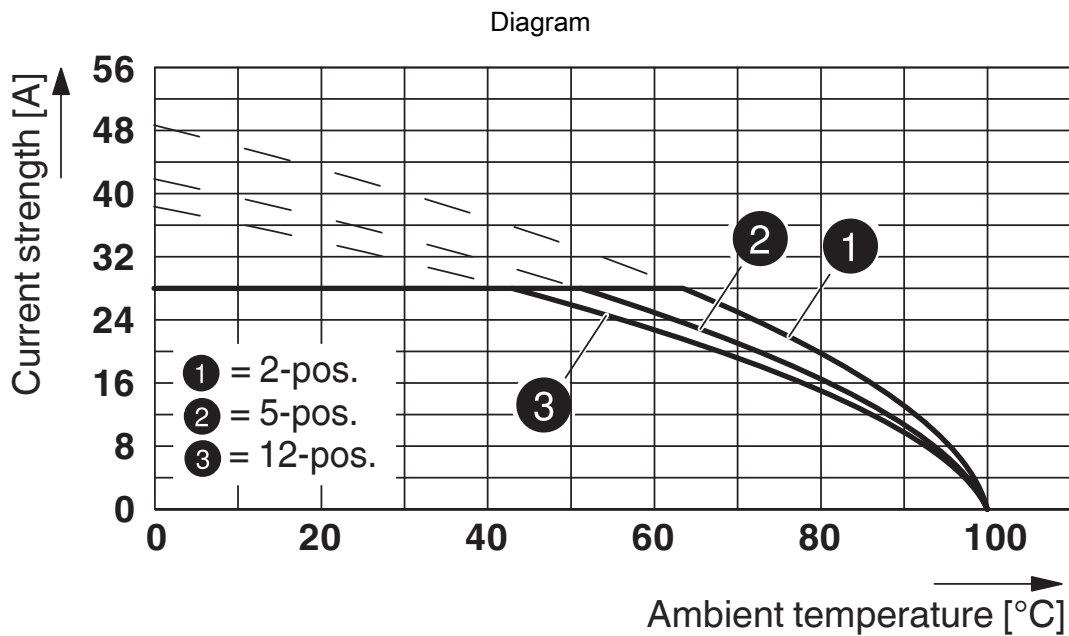

Type: PC 5/...-ST1-7,62 with PC 4/...-G-7,62
 Conductor cross-section: 4 mm²



Type: PC 5/...-ST1-7,62 with PC 4/...-G-7,62
 Conductor cross-section: 6 mm²

177752

<https://www.phoenixcontact.com/us/products/177752>

Diagram



Type: PC 5/...-ST1-7,62 with PCV 4/....-G-7,62
 Conductor cross-section: 4 mm²

Diagram



Type: PC 5/...-ST1-7,62 with PCV 4/....-G-7,62
 Conductor cross-section: 6 mm²

PC 5/ 5-ST1-7,62 - PCB connector



177752

<https://www.phoenixcontact.com/us/products/177752>

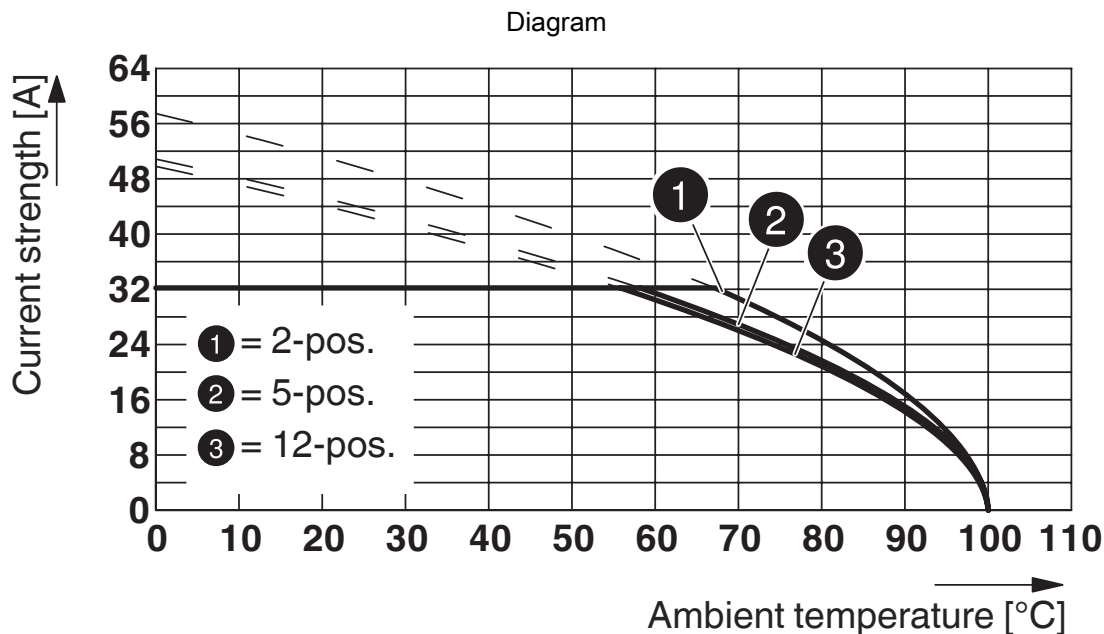

Type: PC 5/...-ST(F)1-7,62 with PC 5/...-GU(F)-7,62

Conductor cross-section: 6 mm²



Type: PC 5/...-ST(F)1-7,62 with PC 5/...-G(F)U-7,62

Conductor cross-section: 10 mm²

PC 5/ 5-ST1-7,62 - PCB connector



177752

<https://www.phoenixcontact.com/us/products/177752>

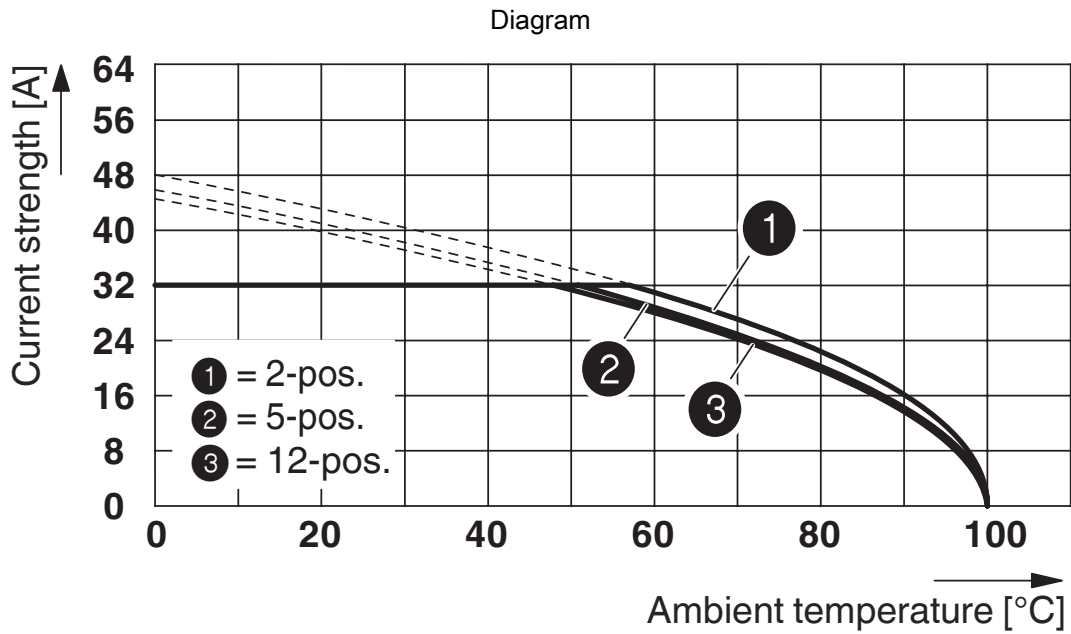

Type: PC 5/...-ST1-7,62 with PCV 5/...-G-7,62
 Conductor cross-section: 6 mm²

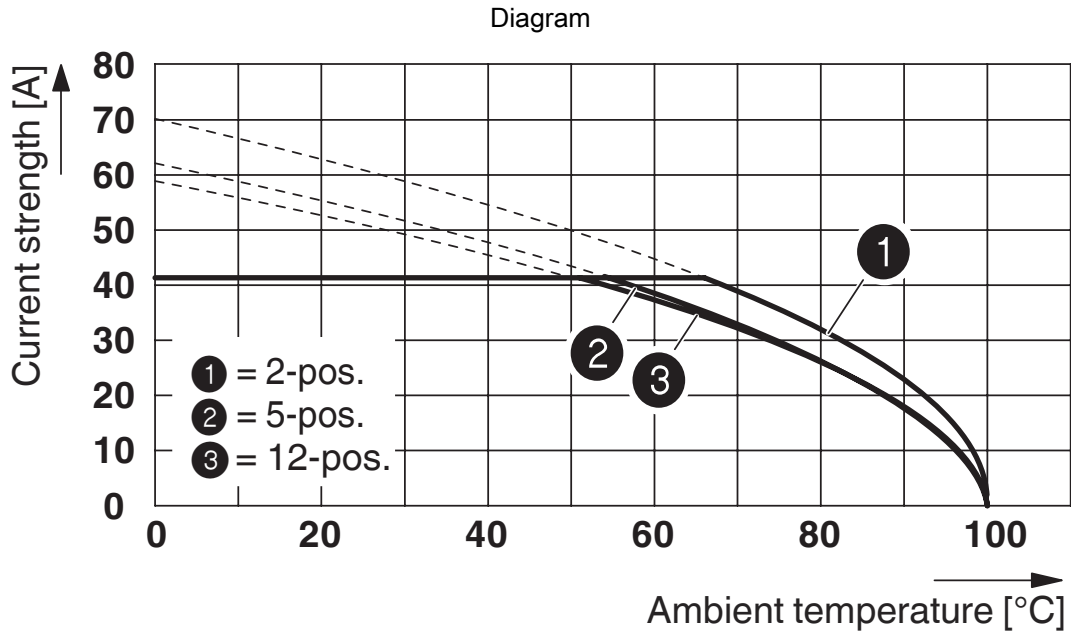

Type: PC 5/...-ST1-7,62 with PCV 5/...-G-7,62
 Conductor cross-section: 10 mm²

PC 5/ 5-ST1-7,62 - PCB connector



177752

<https://www.phoenixcontact.com/us/products/177752>

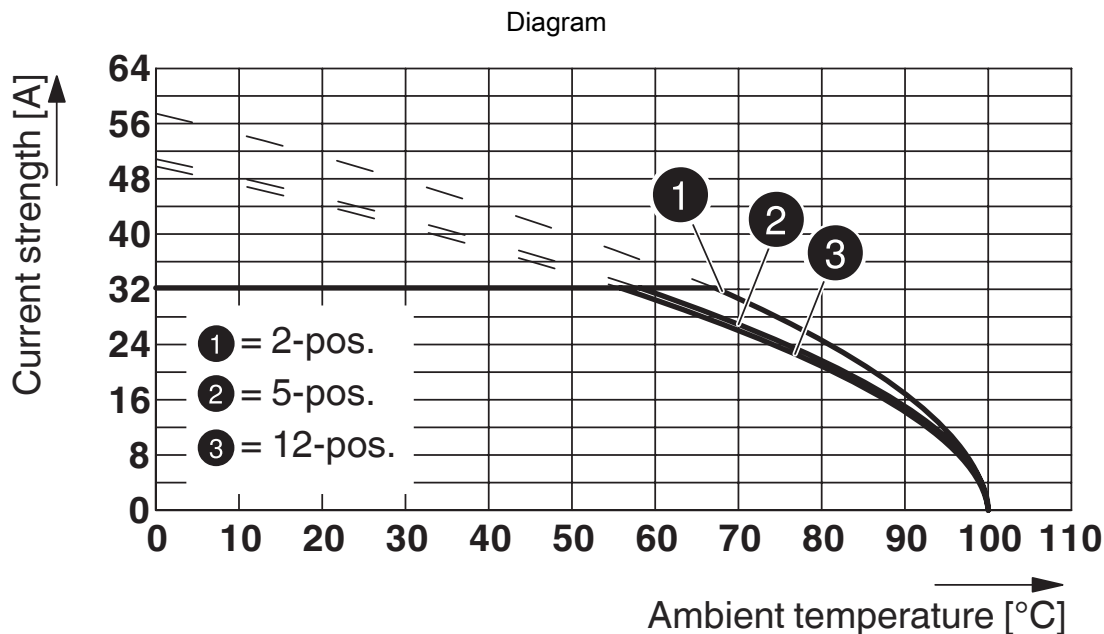

Type: PC 5/...-ST1-7,62 with PC 5/...-GU-7,62 P26 THT R..
 Conductor cross-section: 6 mm²

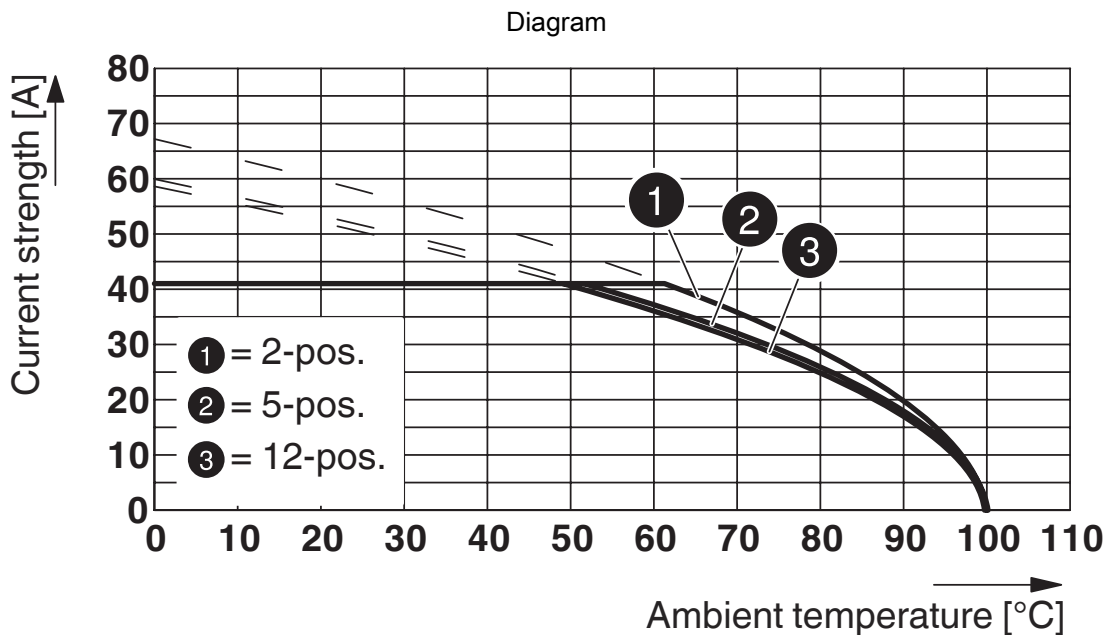

Type: PC 5/...-ST1-7,62 with PC 5/...-GU-7,62 P26 THT R..
 Conductor cross-section: 10 mm²

PC 5/ 5-ST1-7,62 - PCB connector



177752

<https://www.phoenixcontact.com/us/products/177752>

Diagram

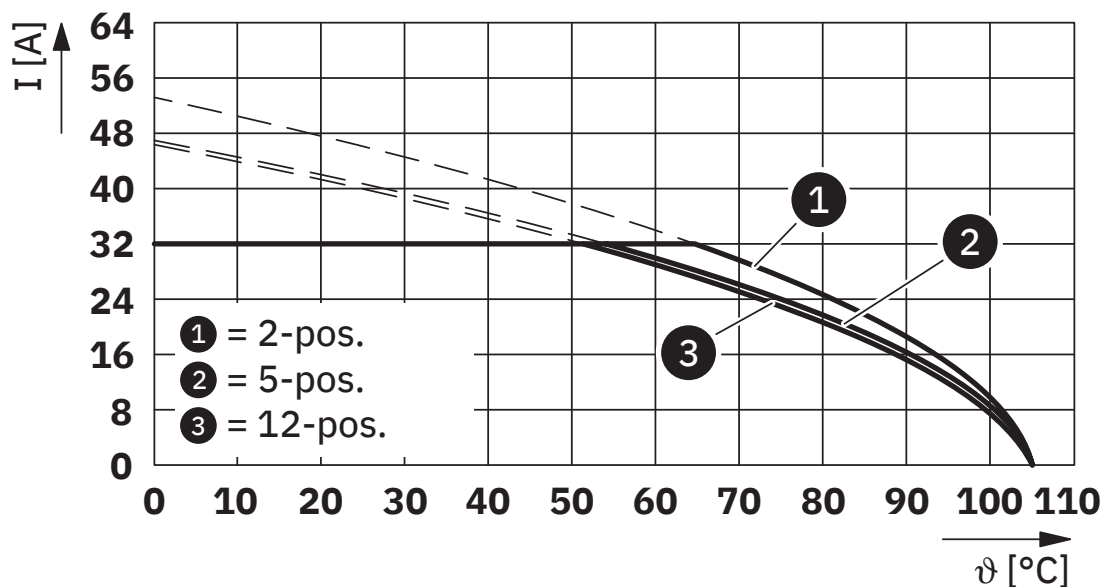

Type: PC 5/...-ST1-7,62 with IPC 5/...-ST-7,62

Diagram

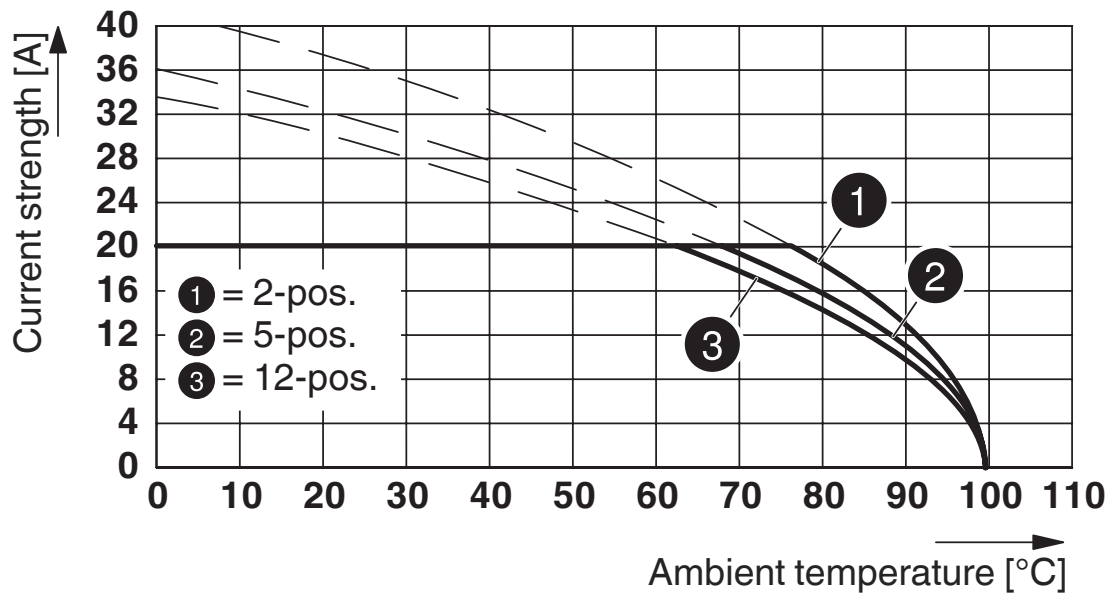

Type: PC 5/...-ST1-7,62 with PCVK 4-7,62
 Conductor cross-section: 4 mm²

PC 5/ 5-ST1-7,62 - PCB connector



177752

<https://www.phoenixcontact.com/us/products/177752>

Diagram



Type: PC 5/...-ST1-7,62 with DFK-PC 5/...-ST-7,62

PC 5/ 5-ST1-7,62 - PCB connector



1777752

<https://www.phoenixcontact.com/us/products/1777752>

Approvals

To download certificates, visit the product detail page: <https://www.phoenixcontact.com/us/products/1777752>

|  cULus Recognized Approval ID: E60425-19920722 | | Nominal voltage U_N | Nominal current I_N | Cross section AWG | Cross section mm^2 |
|---|-------|-----------------------|-----------------------|-------------------|-----------------------------|
| B | | | | | |
| Multi-conductor connection | 600 V | 41 A | 24 - 12 | - | |
| Screw connection | 600 V | 41 A | 24 - 8 | - | |
| C | | | | | |
| Multi-conductor connection | 600 V | 41 A | 24 - 12 | - | |
| Screw connection | 600 V | 41 A | 24 - 8 | - | |

PC 5/ 5-ST1-7,62 - PCB connector



1777752

<https://www.phoenixcontact.com/us/products/1777752>

Classifications

ECLASS

| | |
|-------------|----------|
| ECLASS-13.0 | 27460202 |
| ECLASS-15.0 | 27460202 |

ETIM

| | |
|-----------|----------|
| ETIM 10.0 | EC002638 |
|-----------|----------|

UNSPSC

| | |
|-------------|----------|
| UNSPSC 21.0 | 39121400 |
|-------------|----------|

PC 5/ 5-ST1-7,62 - PCB connector



1777752

<https://www.phoenixcontact.com/us/products/1777752>

Environmental product compliance

EU RoHS

| | |
|---|--------------------|
| Fulfills EU RoHS substance requirements | Yes, No exemptions |
|---|--------------------|

China RoHS

| | |
|--|--|
| Environment friendly use period (EFUP) | EFUP-E |
| | No hazardous substances above the limits |

EU REACH SVHC

| | |
|-------------------------------------|----------------------------|
| REACH candidate substance (CAS No.) | No substance above 0.1 wt% |
|-------------------------------------|----------------------------|

EF3.1 Climate Change

| | |
|---------|---------------|
| CO2e kg | 0.135 kg CO2e |
|---------|---------------|

Phoenix Contact 2026 © - all rights reserved
<https://www.phoenixcontact.com>

Phoenix Contact USA
586 Fulling Mill Road
Middletown, PA 17057, United States
(+717) 944-1300
info@phoenixcon.com