

HC-ADP 24/ 6 OG - Adapter plate



1775444

<https://www.phoenixcontact.com/us/products/1775444>

Please be informed that the data shown in this PDF document is generated from our online catalog. Please find the complete data in the user documentation. Our general terms of use for downloads are valid.



Adapter plates, from type to type, for HEAVYCON wall cutouts, cutout 36 x 52 mm, for type B24 to B6

Commercial data

Item number	1775444
Packing unit	1 pc
Note	Made to order (non-returnable)
Sales key	BF66
Product key	AF7AZD
GTIN	4017918038045
Weight per piece (including packing)	38.5 g
Weight per piece (excluding packing)	38.5 g
Customs tariff number	85472000
Country of origin	DE

HC-ADP 24/ 6 OG - Adapter plate



1775444

<https://www.phoenixcontact.com/us/products/1775444>

Technical data

Product properties

Product type	Adapter plate
Type	B24 to B6

Dimensions

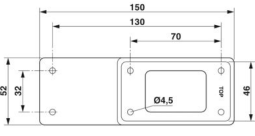
Dimensional drawing	
Width	52 mm
Height	7 mm
Length	150 mm
Drill hole distance, horizontal	130 mm
Drill hole distance, vertical	27 mm
Hole diameter	4.5 mm

Internal dimensions

Internal cutout dimension	36 x 52 mm
---------------------------	------------

Material specifications

Color	orange
Material	PA
Seal material	PTS

Mounting

Assembly note	Cannot be used in panel mounting bases having a pre-mounted cover
	Cannot be used with HC-EVO... PLR BK/HC-STA...

HC-ADP 24/ 6 OG - Adapter plate



1775444

<https://www.phoenixcontact.com/us/products/1775444>

Drawings

Dimensional drawing

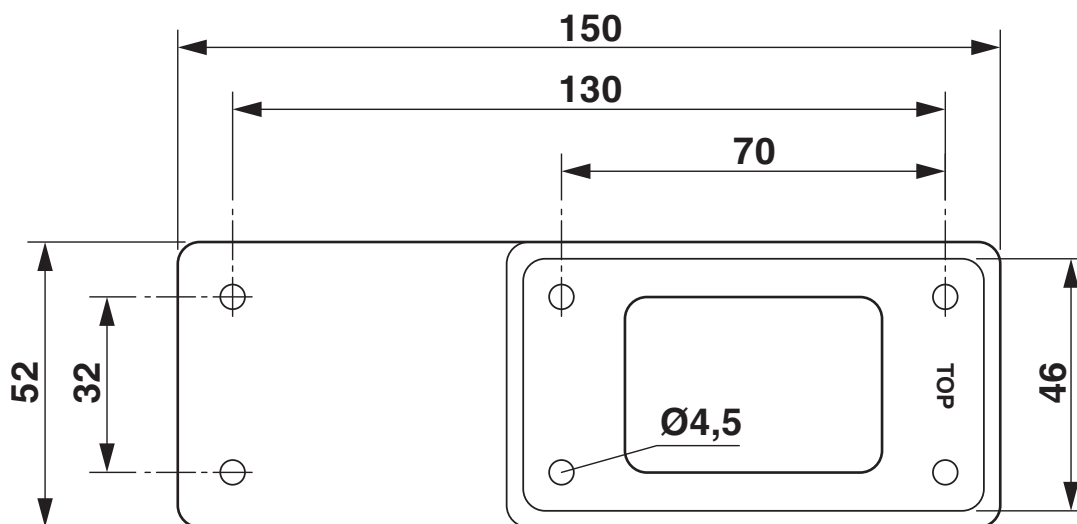

Dimensional drawing

HC-ADP 24/ 6 OG - Adapter plate



1775444

<https://www.phoenixcontact.com/us/products/1775444>

Classifications

ECLASS

ECLASS-13.0	27440201
ECLASS-15.0	27440201

HC-ADP 24/ 6 OG - Adapter plate



1775444

<https://www.phoenixcontact.com/us/products/1775444>

Environmental product compliance

China RoHS

Environment friendly use period (EFUP)	EFUP-50
	An article-related China RoHS declaration table can be found in the download area for the respective article under "Manufacturer declaration". For all articles with EFUP-E, no China RoHS declaration table issued and required.

EU REACH SVHC

REACH candidate substance (CAS No.)	No substance above 0.1 wt%
-------------------------------------	----------------------------

Phoenix Contact 2026 © - all rights reserved
<https://www.phoenixcontact.com>

Phoenix Contact USA
586 Fulling Mill Road
Middletown, PA 17057, United States
(+717) 944-1300
info@phoenixcon.com