

MSTBP 2,5/ 3-ST-5,08 - PCB connector

1769023

<https://www.phoenixcontact.com/us/products/1769023>

Please be informed that the data shown in this PDF document is generated from our online catalog. Please find the complete data in the user documentation. Our general terms of use for downloads are valid.

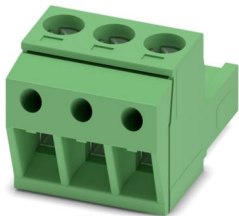

PCB connector, nominal cross section: 2.5 mm², color: green, nominal current: 12 A, rated voltage (III/2): 320 V, contact surface: Sn, contact connection type: Socket, number of potentials: 3, number of rows: 1, number of positions: 3, number of connections: 3, product range: MSTBP 2,5/...-ST, pitch: 5.08 mm, connection method: Screw connection with tension sleeve, screw head form: L Slotted, conductor/PCB connection direction: 0 °, locking clip: - Locking clip, plug-in system: COMBICON MSTB 2,5, locking: without, mounting method: without, type of packaging: packed in cardboard

Your advantages

- Well-known connection principle allows worldwide use
- Low temperature rise, thanks to maximum contact force
- Quick and convenient testing using integrated test option
- Allows connection of two conductors

Commercial data

Item number	1769023
Packing unit	50 pc
Minimum order quantity	50 pc
Sales key	AA03
Product key	AACAGG
GTIN	4017918034351
Weight per piece (including packing)	5.76 g
Weight per piece (excluding packing)	5.411 g
Customs tariff number	85366990
Country of origin	PL

MSTBP 2,5/ 3-ST-5,08 - PCB connector



1769023

<https://www.phoenixcontact.com/us/products/1769023>

Technical data

Product properties

Product type	PCB connector
Product family	MSTBP 2,5/...-ST
Product line	COMBICON Connectors M
Type	Standard
Number of positions	3
Pitch	5.08 mm
Number of connections	3
Number of rows	1
Number of potentials	3
Mounting type	without

Electrical properties

Properties

Nominal current I_N	12 A
Nominal voltage U_N	320 V
Contact resistance	1.3 m Ω
Rated voltage (III/3)	250 V
Rated surge voltage (III/3)	4 kV
Rated voltage (III/2)	320 V
Rated surge voltage (III/2)	4 kV
Rated voltage (II/2)	630 V
Rated surge voltage (II/2)	4 kV

Connection data

Connection technology

Type	Standard
Connector system	COMBICON MSTB 2,5
Nominal cross section	2.5 mm ²
Contact connection type	Socket

Interlock

Locking type	without
Mounting type	without

Conductor connection

Connection method	Screw connection with tension sleeve
Conductor/PCB connection direction	0 °
Conductor cross-section rigid	0.2 mm ² ... 2.5 mm ²
Conductor cross-section flexible	0.2 mm ² ... 2.5 mm ²
Conductor cross-section AWG	24 ... 12

MSTBP 2,5/ 3-ST-5,08 - PCB connector



1769023

<https://www.phoenixcontact.com/us/products/1769023>

Conductor cross-section, flexible, with ferrule, without plastic sleeve	0.25 mm ² ... 2.5 mm ²
Conductor cross-section, flexible, with ferrule, with plastic sleeve	0.25 mm ² ... 2.5 mm ²
2 conductors with same cross section, rigid	0.2 mm ² ... 1 mm ²
2 conductors with same cross section, flexible	0.2 mm ² ... 1.5 mm ²
2 conductors with same cross section, flexible, with ferrule without plastic sleeve	0.25 mm ² ... 1 mm ²
2 conductors with the same cross section, flexible, with TWIN ferrule with plastic sleeve	0.5 mm ² ... 1.5 mm ²
Cylindrical gauge a x b / diameter	2.8 mm x 2.0 mm / 2.4 mm
Stripping length	7 mm
Drive form screw head	Slotted (L)
Tightening torque	0.5 Nm ... 0.6 Nm

Specifications for ferrules without insulating collar

recommended crimping tool	1212034 CRIMPFOX 6
---------------------------	--------------------

Specifications for ferrules with insulating collar

recommended crimping tool	1212034 CRIMPFOX 6
---------------------------	--------------------

Material specifications

Material data - contact

Note	WEEE/RoHS-compliant, free of whiskers according to IEC 60068-2-82/JEDEC JESD 201
Contact material	Cu alloy
Surface characteristics	hot-dip tin-plated
Metal surface terminal point (top layer)	Tin (5 µm - 7 µm Sn)
Metal surface contact area (top layer)	Tin (5 µm - 7 µm Sn)

Material data - housing

Color (Housing)	green (6021)
Insulating material	PA
Insulating material group	I
CTI according to IEC 60112	600
Flammability rating according to UL 94	V0
Glow wire flammability index GWFI according to EN 60695-2-12	850
Glow wire ignition temperature GWIT according to EN 60695-2-13	775
Temperature for the ball pressure test according to EN 60695-10-2	125 °C

Dimensions

MSTBP 2,5/ 3-ST-5,08 - PCB connector



1769023

<https://www.phoenixcontact.com/us/products/1769023>

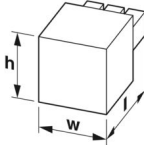
Dimensional drawing	
Pitch	5.08 mm
Width [w]	15.24 mm
Height [h]	15 mm
Length [l]	21.3 mm

Notes

Notes on operation	In accordance with IEC 61984, COMBICON connectors have no switching power (COC). During designated use, they must not be plugged in or disconnected when carrying voltage or under load.
--------------------	--

Mechanical tests

Test for conductor damage and slackening

Specification	IEC 60999-1:1999-11
Result	Test passed

Pull-out test

Specification	IEC 60999-1:1999-11
Conductor cross-section/conductor type/tractive force setpoint/actual value	0.2 mm ² / solid / > 10 N
	0.2 mm ² / flexible / > 10 N
	2.5 mm ² / solid / > 50 N
	2.5 mm ² / flexible / > 50 N

Insertion and withdrawal forces

Specification	IEC 60512-13-2:2006-02
Result	Test passed
No. of cycles	25
Insertion strength per pos. approx.	8 N
Withdraw strength per pos. approx.	6 N

Torque test

Specification	IEC 60999-1:1999-11
---------------	---------------------

Resistance of inscriptions

Specification	IEC 60068-2-70:1995-12
Result	Test passed

Polarization and coding

Specification	IEC 60512-13-5:2006-02
Result	Test passed

Visual inspection

MSTBP 2,5/ 3-ST-5,08 - PCB connector



1769023

<https://www.phoenixcontact.com/us/products/1769023>

Specification	IEC 60512-1-1:2002-02
Result	Test passed

Dimension check

Specification	IEC 60512-1-2:2002-02
Result	Test passed

Environmental and real-life conditions

Durability test

Specification	IEC 60512-9-1:2010-03
Impulse withstand voltage at sea level	4.8 kV
Contact resistance R_1	1.3 m Ω
Contact resistance R_2	1.4 m Ω
Insertion/withdrawal cycles	25
Insulation resistance, neighboring positions	> 5 M Ω

Climatic test

Specification	ISO 6988:1985-02
Corrosive stress	0.2 dm ³ SO ₂ on 300 dm ³ /40 °C/1 cycle
Thermal stress	100 °C/168 h
Power-frequency withstand voltage	2.21 kV

Vibration test

Specification	IEC 60068-2-6:2007-12
Frequency	10 - 150 - 10 Hz
Sweep speed	1 octave/min
Amplitude	0.35 mm (10 Hz ... 60.1 Hz)
Acceleration	5g (60.1 Hz ... 150 Hz)
Test duration per axis	2.5 h
Test directions	X-, Y- and Z-axis

Ambient conditions

Ambient temperature (storage/transport)	-40 °C ... 70 °C
Relative humidity (storage/transport)	30 % ... 70 %
Ambient temperature (assembly)	-5 °C ... 100 °C
Ambient temperature (operation)	-40 °C ... 100 °C (dependent on the derating curve)

Electrical tests

Thermal test | Test group C

Specification	IEC 60512-5-1:2002-02
Tested number of positions	12

Insulation resistance

Specification	IEC 60512-3-1:2002-02
Insulation resistance, neighboring positions	> 5 M Ω

MSTBP 2,5/ 3-ST-5,08 - PCB connector



1769023

<https://www.phoenixcontact.com/us/products/1769023>

Air clearances and creepage distances |

Specification	IEC 60664-1:2007-04
Insulating material group	I
Comparative tracking index (IEC 60112)	CTI 600
Rated insulation voltage (III/3)	250 V
Rated surge voltage (III/3)	4 kV
minimum clearance value - non-homogenous field (III/3)	3 mm
minimum creepage distance (III/3)	3.2 mm
Rated insulation voltage (III/2)	320 V
Rated surge voltage (III/2)	4 kV
minimum clearance value - non-homogenous field (III/2)	3 mm
minimum creepage distance (III/2)	3 mm
Rated insulation voltage (II/2)	630 V
Rated surge voltage (II/2)	4 kV
minimum clearance value - non-homogenous field (II/2)	3 mm
minimum creepage distance (II/2)	3.2 mm

Packaging specifications

Type of packaging	packed in cardboard
-------------------	---------------------

1769023

<https://www.phoenixcontact.com/us/products/1769023>

Drawings

Diagram

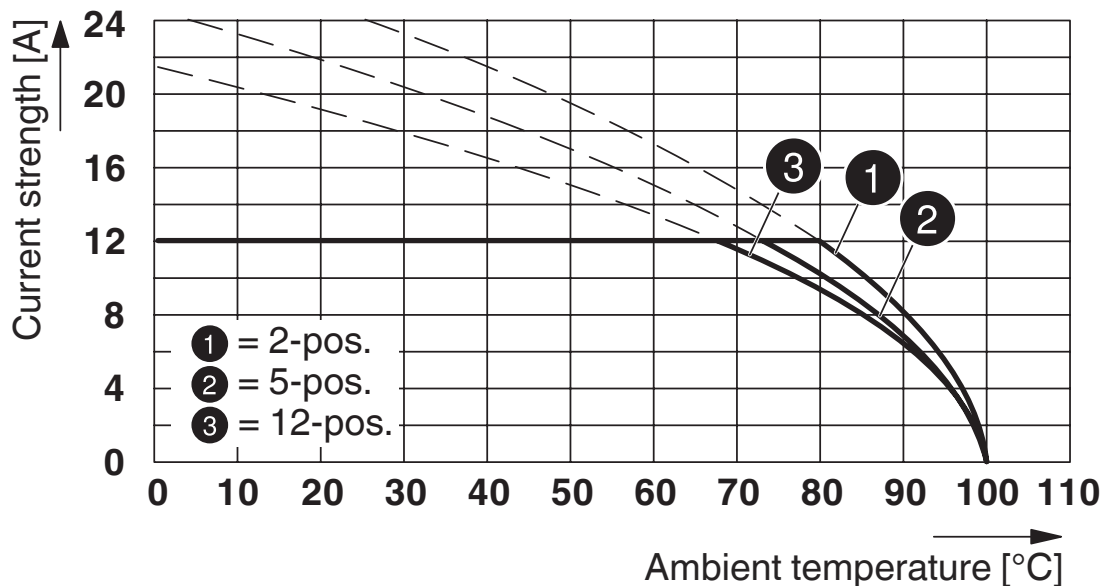

Type: MSTBP 2,5/...-ST-5,08 with CC 2,5/...-G-5,08 P26 THR

Diagram

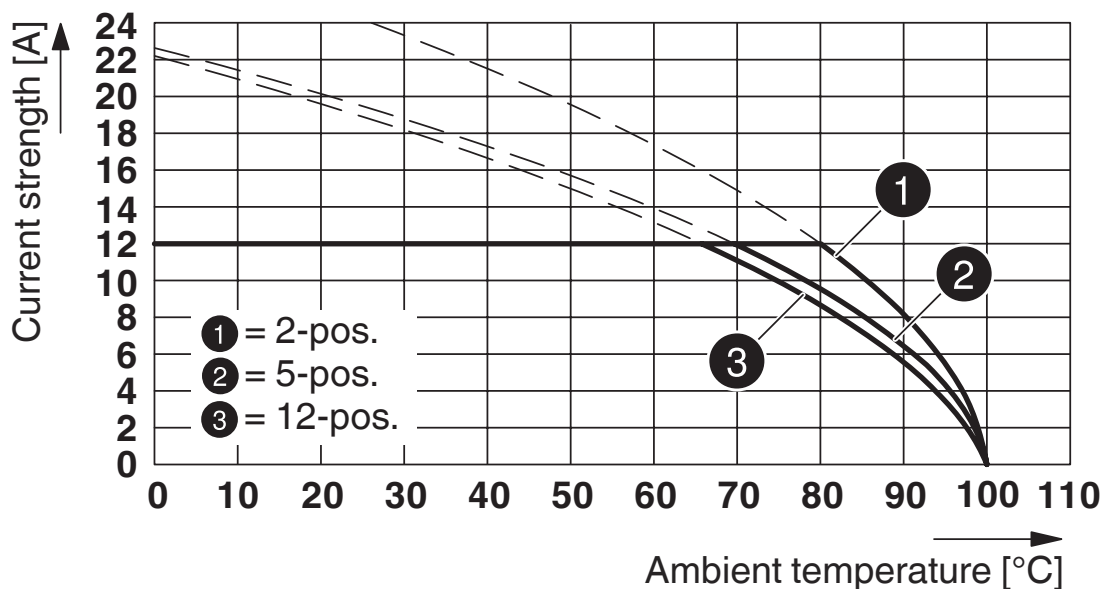

Type: MSTBP 2,5/...-ST-5,08 with CCA 2,5/...-G-5,08 P26THR

1769023

<https://www.phoenixcontact.com/us/products/1769023>

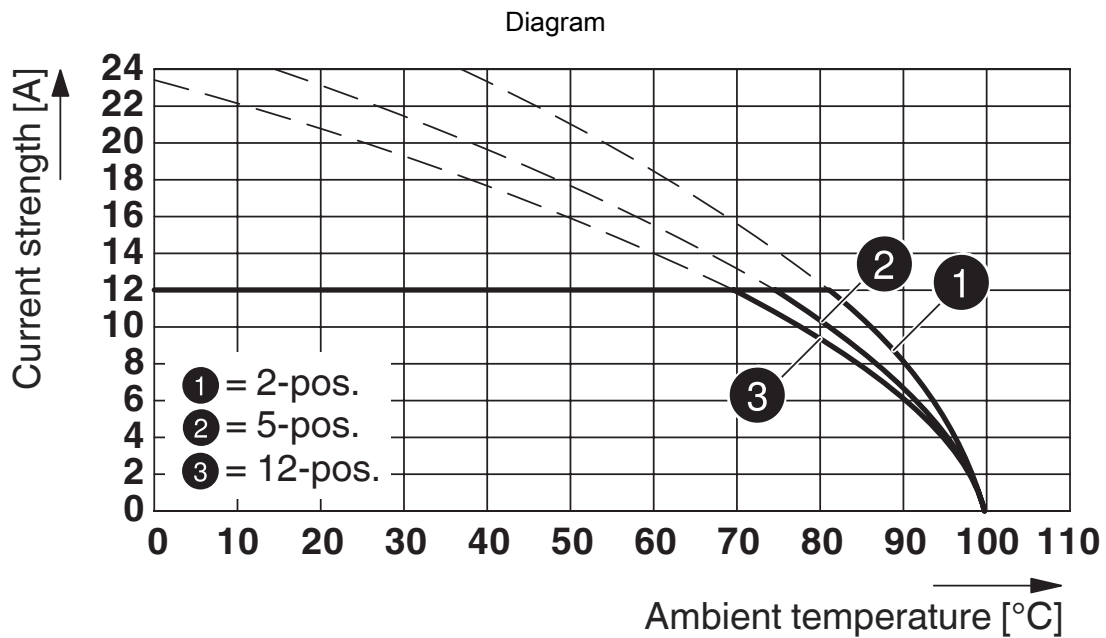

Type: MSTBP 2,5/...-ST-5,08 with CCV 2,5/...-G-5,08 P26THR



Type: MSTBP 2,5/...-ST-5,08 with CCVA 2,5/...-G-5,08 P26THR

1769023

<https://www.phoenixcontact.com/us/products/1769023>



Type: MSTBP 2,5/...-ST-5,08 with MDSTB 2,5/...-G-5,08



Type: MSTBP 2,5/...-ST-5,08 with MDSTBA 2,5/...-G-5,08

1769023

<https://www.phoenixcontact.com/us/products/1769023>



Type: MSTBP 2,5/...-ST-5,08 with MDSTBV 2,5/...-G-5,08



Type: MSTBP 2,5/...-ST-5,08 with MSTB 2,5/...-G-5,08



Type: MSTBP 2,5/...-ST-5,08 with MDSTBW 2,5/...-G-5,08



Type: MSTBP 2,5/...-ST-5,08 with MDSTBVA 2,5/...-G-5,08



Type: MSTBP 2,5/...-ST-5,08 with MSTBW 2,5/...-G-5,08



Type: MSTBP 2,5/...-ST-5,08 with MSTBVA 2,5/...-G-5,08

1769023

<https://www.phoenixcontact.com/us/products/1769023>

Diagram



Type: MSTBP 2,5/...-ST-5,08 with MSTBV 2,5/...-G-5,08

Diagram



Type: MSTBP 2,5/...-ST-5,08 with MSTBA 2,5/...-G-5,08-5,08

MSTBP 2,5/ 3-ST-5,08 - PCB connector



1769023

<https://www.phoenixcontact.com/us/products/1769023>



Type: MSTBP 2,5/...-ST-5,08 with MDSTB 2,5/...-G1-5,08



Type: MSTBP 2,5/...-ST-5,08 with MDSTBV 2,5/...-G1-5,08

MSTBP 2,5/ 3-ST-5,08 - PCB connector



1769023

<https://www.phoenixcontact.com/us/products/1769023>

Diagram



Type: MSTBP 2,5/...-ST-5,08 with SMSTBA 2,5/...-G-5,08

Diagram



Type: MSTBP 2,5/...-ST-5,08 with SMSTB 2,5/...-G-5,08

MSTBP 2,5/ 3-ST-5,08 - PCB connector



1769023

<https://www.phoenixcontact.com/us/products/1769023>

Approvals

To download certificates, visit the product detail page: <https://www.phoenixcontact.com/us/products/1769023>

 CSA Approval ID: 13631-2585951				
	Nominal voltage U_N	Nominal current I_N	Cross section AWG	Cross section mm^2
B				
	300 V	10 A	28 - 12	-
D				
	300 V	10 A	28 - 12	-

 cULus Recognized Approval ID: E60425-19931011				
	Nominal voltage U_N	Nominal current I_N	Cross section AWG	Cross section mm^2
B				
	300 V	15 A	30 - 12	-
D				
	300 V	10 A	30 - 12	-

 VDE Zeichengenehmigung Approval ID: 40050694				
	Nominal voltage U_N	Nominal current I_N	Cross section AWG	Cross section mm^2
keine				
	250 V	12 A	-	0.2 - 2.5

MSTBP 2,5/ 3-ST-5,08 - PCB connector



1769023

<https://www.phoenixcontact.com/us/products/1769023>

Classifications

ECLASS

ECLASS-13.0	27460202
ECLASS-15.0	27460202

ETIM

ETIM 10.0	EC002638
-----------	----------

UNSPSC

UNSPSC 21.0	39121400
-------------	----------

MSTBP 2,5/ 3-ST-5,08 - PCB connector



1769023

<https://www.phoenixcontact.com/us/products/1769023>

Environmental product compliance

EU RoHS

Fulfills EU RoHS substance requirements	Yes, No exemptions
---	--------------------

China RoHS

Environment friendly use period (EFUP)	EFUP-E
	No hazardous substances above the limits

EU REACH SVHC

REACH candidate substance (CAS No.)	No substance above 0.1 wt%
-------------------------------------	----------------------------

EF3.1 Climate Change

CO2e kg	0.112 kg CO2e
---------	---------------

Phoenix Contact 2026 © - all rights reserved
<https://www.phoenixcontact.com>

Phoenix Contact USA
586 Fulling Mill Road
Middletown, PA 17057, United States
(+717) 944-1300
info@phoenixcon.com