

TSPC 5/ 9-STCL-7,62 - PCB connector

1765489

<https://www.phoenixcontact.com/us/products/1765489>

Please be informed that the data shown in this PDF document is generated from our online catalog. Please find the complete data in the user documentation. Our general terms of use for downloads are valid.

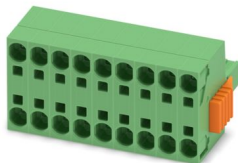

PCB TWIN plug, nominal cross section: 6 mm², color: green, nominal current: 32 A, rated voltage (III/2): 1000 V, contact surface: Sn, contact connection type: Socket, number of potentials: 9, number of rows: 1, number of positions: 9, number of connections: 18, product range: TSPC 5/...-STCL, pitch: 7.62 mm, connection method: Push-in spring connection, conductor/PCB connection direction: 0 °, locking clip: - without locking clip, plug-in system: COMBICON PC 5, locking: Clip locking, mounting method: Click & Lock latching slide, type of packaging: packed in cardboard

Your advantages

- Time saving push-in connection, tools not required
- Defined contact force ensures that contact remains stable over the long term
- Clamping space opened by means of fixed screwdriver enables convenient conductor connection
- Integrated double steel spring provides additional safety in the event of temperature and power fluctuations
- Potentials can be easily looped through – ideal for BUS applications
- Automatic locking and intuitive release through Lock and Release operating lever in contrasting color
- 600 V UL approval in the smallest of dimensions

Commercial data

Item number	1765489
Packing unit	10 pc
Minimum order quantity	50 pc
Note	Made to order (non-returnable)
Sales key	AA04
Product key	AADFBG
GTIN	4046356442251
Weight per piece (including packing)	72.79 g
Weight per piece (excluding packing)	72.58 g
Customs tariff number	85366990
Country of origin	BG

TSPC 5/ 9-STCL-7,62 - PCB connector



1765489

<https://www.phoenixcontact.com/us/products/1765489>

Technical data

Product properties

Product type	PCB TWIN plug
Product family	TSPC 5/...-STCL
Product line	COMBICON Connectors L
Type	Standard
Number of positions	9
Pitch	7.62 mm
Number of connections	18
Number of rows	1
Number of potentials	9
Mounting type	Click & Lock latching slide

Electrical properties

Properties

Nominal current I_N	32 A
Nominal voltage U_N	1000 V
Rated voltage (III/3)	1000 V
Rated surge voltage (III/3)	8 kV
Rated voltage (III/2)	1000 V
Rated surge voltage (III/2)	8 kV
Rated voltage (II/2)	1000 V
Rated surge voltage (II/2)	6 kV

Connection data

Connection technology

Type	Standard
Connector system	COMBICON PC 5
Nominal cross section	6 mm ²
Contact connection type	Socket

Interlock

Locking type	Clip locking
Mounting type	Click & Lock latching slide

Conductor connection

Connection method	Push-in spring connection
Conductor/PCB connection direction	0 °
Conductor cross-section rigid	0.2 mm ² ... 10 mm ²
Conductor cross-section flexible	0.2 mm ² ... 6 mm ²
Conductor cross-section AWG	24 ... 8
Conductor cross-section, flexible, with ferrule, without plastic sleeve	0.25 mm ² ... 6 mm ²

TSPC 5/ 9-STCL-7,62 - PCB connector



1765489

<https://www.phoenixcontact.com/us/products/1765489>

Conductor cross-section, flexible, with ferrule, with plastic sleeve	0.25 mm ² ... 4 mm ²
2 conductors with the same cross section, flexible, with TWIN ferrule with plastic sleeve	0.25 mm ² ... 1.5 mm ²
Cylindrical gauge a x b / diameter	4.3 mm x 4.0 mm / 4.0 mm
Stripping length	15 mm

Specifications for ferrules without insulating collar

recommended crimping tool	1212034 CRIMPFOX 6
	1213144 CRIMPFOX CENTRUS 6S
	1213146 CRIMPFOX CENTRUS 6H
ferrules without insulating collar, according to DIN 46228-1	Cross section: 0.5 mm ² ; Length: 10 mm ... 15 mm
	Cross section: 0.75 mm ² ; Length: 10 mm ... 15 mm
	Cross section: 1 mm ² ; Length: 10 mm ... 15 mm
	Cross section: 1.5 mm ² ; Length: 12 mm ... 15 mm
	Cross section: 2.5 mm ² ; Length: 12 mm ... 15 mm
	Cross section: 4 mm ² ; Length: 12 mm ... 15 mm
	Cross section: 6 mm ² ; Length: 12 mm ... 15 mm

Specifications for ferrules with insulating collar

recommended crimping tool	1212034 CRIMPFOX 6
	1213144 CRIMPFOX CENTRUS 6S
	1213146 CRIMPFOX CENTRUS 6H
ferrules with insulating collar, according to DIN 46228-4	Cross section: 0.5 mm ² ; Length: 10 mm ... 15 mm
	Cross section: 0.75 mm ² ; Length: 12 mm ... 15 mm
	Cross section: 1 mm ² ; Length: 12 mm ... 15 mm
	Cross section: 1.5 mm ² ; Length: 12 mm ... 15 mm
	Cross section: 2.5 mm ² ; Length: 12 mm ... 15 mm
	Cross section: 4 mm ² ; Length: 12 mm ... 15 mm

Material specifications

Material data - contact

Note	WEEE/RoHS-compliant, free of whiskers according to IEC 60068-2-82/JEDEC JESD 201
Contact material	Cu alloy
Surface characteristics	hot-dip tin-plated
Metal surface terminal point (top layer)	Tin (4 µm - 8 µm Sn)
Metal surface contact area (top layer)	Tin (4 µm - 8 µm Sn)

Material data - housing

Color (Housing)	green (6021)
Insulating material	PA
Insulating material group	I
CTI according to IEC 60112	600
Flammability rating according to UL 94	V0
Glow wire flammability index GWFI according to EN 60695-2-12	850

TSPC 5/ 9-STCL-7,62 - PCB connector



1765489

<https://www.phoenixcontact.com/us/products/1765489>

Glow wire ignition temperature GWIT according to EN 60695-2-13	775
Temperature for the ball pressure test according to EN 60695-10-2	125 °C

Material data – actuating element

Color (Actuating element)	orange (2003)
---------------------------	---------------

Dimensions

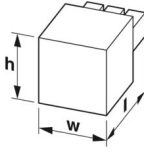
Dimensional drawing	
Pitch	7.62 mm
Width [w]	76.58 mm
Height [h]	35.05 mm
Length [l]	41.45 mm

Notes

Notes on operation	In accordance with IEC 61984, COMBICON connectors have no switching power (COC). During designated use, they must not be plugged in or disconnected when carrying voltage or under load.
--------------------	--

Environmental and real-life conditions

Ambient conditions

Ambient temperature (storage/transport)	-40 °C ... 70 °C
Relative humidity (storage/transport)	30 % ... 70 %
Ambient temperature (assembly)	-5 °C ... 100 °C
Ambient temperature (operation)	-40 °C ... 100 °C (dependent on the derating curve)

Ambient conditions

Ambient temperature (operation)	-40 °C ... 100 °C (dependent on the derating curve)
Ambient temperature (storage/transport)	-40 °C ... 70 °C
Relative humidity (storage/transport)	30 % ... 70 %
Ambient temperature (assembly)	-5 °C ... 100 °C

Electrical tests

Air clearances and creepage distances |

Specification	IEC 60664-1:2007-04
Insulating material group	I
Comparative tracking index (IEC 60112)	CTI 600
Rated insulation voltage (III/3)	1000 V
Rated surge voltage (III/3)	8 kV
minimum clearance value - non-homogenous field (III/3)	8 mm

TSPC 5/ 9-STCL-7,62 - PCB connector



1765489

<https://www.phoenixcontact.com/us/products/1765489>

minimum creepage distance (III/3)	12.5 mm
Rated insulation voltage (III/2)	1000 V
Rated surge voltage (III/2)	8 kV
minimum clearance value - non-homogenous field (III/2)	8 mm
minimum creepage distance (III/2)	8 mm
Rated insulation voltage (II/2)	1000 V
Rated surge voltage (II/2)	6 kV
minimum clearance value - non-homogenous field (II/2)	5.5 mm
minimum creepage distance (II/2)	5.5 mm

Packaging specifications

Type of packaging	packed in cardboard
-------------------	---------------------

TSPC 5/ 9-STCL-7,62 - PCB connector



1765489

<https://www.phoenixcontact.com/us/products/1765489>

Approvals

To download certificates, visit the product detail page: <https://www.phoenixcontact.com/us/products/1765489>

 cULus Recognized Approval ID: E60425-19920722		Nominal voltage U_N	Nominal current I_N	Cross section AWG	Cross section mm^2
B		600 V	31 A	24 - 8	-
C		600 V	31 A	24 - 8	-

TSPC 5/ 9-STCL-7,62 - PCB connector



1765489

<https://www.phoenixcontact.com/us/products/1765489>

Classifications

ECLASS

ECLASS-13.0	27460202
ECLASS-15.0	27460202

ETIM

ETIM 10.0	EC002638
-----------	----------

UNSPSC

UNSPSC 21.0	39121400
-------------	----------

TSPC 5/ 9-STCL-7,62 - PCB connector



1765489

<https://www.phoenixcontact.com/us/products/1765489>

Environmental product compliance

EU RoHS

Fulfills EU RoHS substance requirements	Yes, No exemptions
---	--------------------

China RoHS

Environment friendly use period (EFUP)	EFUP-E
	No hazardous substances above the limits

EU REACH SVHC

REACH candidate substance (CAS No.)	No substance above 0.1 wt%
-------------------------------------	----------------------------

EF3.1 Climate Change

CO2e kg	0.408 kg CO2e
---------	---------------

Phoenix Contact 2026 © - all rights reserved
<https://www.phoenixcontact.com>

Phoenix Contact USA
586 Fulling Mill Road
Middletown, PA 17057, United States
(+717) 944-1300
info@phoenixcon.com