

MSTB 2,5/ 9-STZ - PCB connector

1758995

<https://www.phoenixcontact.com/us/products/1758995>

Please be informed that the data shown in this PDF document is generated from our online catalog. Please find the complete data in the user documentation. Our general terms of use for downloads are valid.

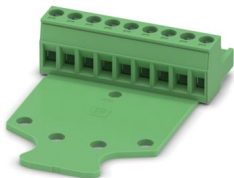

PCB connector, nominal cross section: 2.5 mm², color: green, nominal current: 12 A, rated voltage (III/2): 320 V, contact surface: Sn, contact connection type: Socket, number of potentials: 9, number of rows: 1, number of positions: 9, number of connections: 9, product range: MSTB 2,5/...-ST, pitch: 5 mm, connection method: Screw connection with tension sleeve, screw head form: L Slotted, conductor/PCB connection direction: 0 °, locking clip: - Locking clip, plug-in system: COMBICON MSTB 2,5, locking: without, mounting method: without, type of packaging: packed in cardboard, Pull-out aid (STZ13)

Your advantages

- Standard plug-in system for 320 V (III/2)
- Individual position coding by inserting coding profiles

Commercial data

| | |
|--------------------------------------|--------------------------------|
| Item number | 1758995 |
| Packing unit | 50 pc |
| Minimum order quantity | 50 pc |
| Note | Made to order (non-returnable) |
| Sales key | AA03 |
| Product key | AACAFE |
| GTIN | 4017918030469 |
| Weight per piece (including packing) | 18.308 g |
| Weight per piece (excluding packing) | 16.928 g |
| Customs tariff number | 85366990 |
| Country of origin | DE |

MSTB 2,5/ 9-STZ - PCB connector



1758995

<https://www.phoenixcontact.com/us/products/1758995>

Technical data

Product properties

| | |
|-----------------------|-------------------------|
| Product type | PCB connector |
| Product family | MSTB 2,5/...-ST |
| Product line | COMBICON Connectors M |
| Type | Standard |
| Number of positions | 9 |
| Pitch | 5 mm |
| Number of connections | 9 |
| Number of rows | 1 |
| Number of potentials | 9 |
| Mounting type | without |
| Strain relief | STZ13 Pull-out aid 39.9 |

Electrical properties

Properties

| | |
|-----------------------------|-------|
| Nominal current I_N | 12 A |
| Nominal voltage U_N | 320 V |
| Rated voltage (III/3) | 250 V |
| Rated surge voltage (III/3) | 4 kV |
| Rated voltage (III/2) | 320 V |
| Rated surge voltage (III/2) | 4 kV |
| Rated voltage (II/2) | 630 V |
| Rated surge voltage (II/2) | 4 kV |

Connection data

Connection technology

| | |
|-------------------------|---------------------|
| Type | Standard |
| Connector system | COMBICON MSTB 2,5 |
| Nominal cross section | 2.5 mm ² |
| Contact connection type | Socket |

Interlock

| | |
|---------------|---------|
| Locking type | without |
| Mounting type | without |

Conductor connection

| | |
|------------------------------------|---|
| Connection method | Screw connection with tension sleeve |
| Conductor/PCB connection direction | 0 ° |
| Conductor cross-section rigid | 0.2 mm ² ... 2.5 mm ² |
| Conductor cross-section flexible | 0.2 mm ² ... 2.5 mm ² |
| Conductor cross-section AWG | 24 ... 12 |

MSTB 2,5/ 9-STZ - PCB connector



1758995

<https://www.phoenixcontact.com/us/products/1758995>

| | |
|---|--|
| Conductor cross-section, flexible, with ferrule, without plastic sleeve | 0.25 mm ² ... 2.5 mm ² |
| Conductor cross-section, flexible, with ferrule, with plastic sleeve | 0.25 mm ² ... 2.5 mm ² |
| 2 conductors with same cross section, rigid | 0.2 mm ² ... 1 mm ² |
| 2 conductors with same cross section, flexible | 0.2 mm ² ... 1.5 mm ² |
| 2 conductors with same cross section, flexible, with ferrule without plastic sleeve | 0.25 mm ² ... 1 mm ² |
| 2 conductors with the same cross section, flexible, with TWIN ferrule with plastic sleeve | 0.5 mm ² ... 1.5 mm ² |
| Cylindrical gauge a x b / diameter | 2.8 mm x 2.0 mm / 2.4 mm |
| Stripping length | 7 mm |
| Drive form screw head | Slotted (L) |
| Tightening torque | 0.5 Nm ... 0.6 Nm |

Specifications for ferrules without insulating collar

| | |
|---------------------------|--------------------|
| recommended crimping tool | 1212034 CRIMPFOX 6 |
|---------------------------|--------------------|

Specifications for ferrules with insulating collar

| | |
|---------------------------|--------------------|
| recommended crimping tool | 1212034 CRIMPFOX 6 |
|---------------------------|--------------------|

Material specifications

Material data - contact

| | |
|--|--|
| Note | WEEE/RoHS-compliant, free of whiskers according to IEC 60068-2-82/JEDEC JESD 201 |
| Contact material | Cu alloy |
| Surface characteristics | hot-dip tin-plated |
| Metal surface terminal point (top layer) | Tin (5 µm - 7 µm Sn) |
| Metal surface contact area (top layer) | Tin (5 µm - 7 µm Sn) |

Material data - housing

| | |
|---|--------------|
| Color (Housing) | green (6021) |
| Insulating material | PA |
| Insulating material group | I |
| CTI according to IEC 60112 | 600 |
| Flammability rating according to UL 94 | V0 |
| Glow wire flammability index GWFI according to EN 60695-2-12 | 850 |
| Glow wire ignition temperature GWIT according to EN 60695-2-13 | 775 |
| Temperature for the ball pressure test according to EN 60695-10-2 | 125 °C |

Dimensions

MSTB 2,5/ 9-STZ - PCB connector

1758995

<https://www.phoenixcontact.com/us/products/1758995>

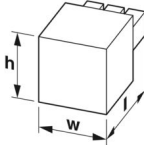
| | |
|---------------------|--|
| Dimensional drawing |  |
| Pitch | 5 mm |
| Width [w] | 45 mm |
| Height [h] | 15.5 mm |
| Length [l] | 63.9 mm |

Notes

| | |
|--------------------|--|
| Notes on operation | In accordance with IEC 61984, COMBICON connectors have no switching power (COC). During designated use, they must not be plugged in or disconnected when carrying voltage or under load. |
|--------------------|--|

Environmental and real-life conditions

Ambient conditions

| | |
|---|---|
| Ambient temperature (storage/transport) | -40 °C ... 70 °C |
| Relative humidity (storage/transport) | 30 % ... 70 % |
| Ambient temperature (assembly) | -5 °C ... 100 °C |
| Ambient temperature (operation) | -40 °C ... 100 °C (dependent on the derating curve) |

Electrical tests

Air clearances and creepage distances |

| | |
|--|---------------------|
| Specification | IEC 60664-1:2007-04 |
| Insulating material group | I |
| Comparative tracking index (IEC 60112) | CTI 600 |
| Rated insulation voltage (III/3) | 250 V |
| Rated surge voltage (III/3) | 4 kV |
| minimum clearance value - non-homogenous field (III/3) | 3 mm |
| minimum creepage distance (III/3) | 3.2 mm |
| Rated insulation voltage (III/2) | 320 V |
| Rated surge voltage (III/2) | 4 kV |
| minimum clearance value - non-homogenous field (III/2) | 3 mm |
| minimum creepage distance (III/2) | 3 mm |
| Rated insulation voltage (II/2) | 630 V |
| Rated surge voltage (II/2) | 4 kV |
| minimum clearance value - non-homogenous field (II/2) | 3 mm |
| minimum creepage distance (II/2) | 3.2 mm |

Packaging specifications

| | |
|-------------------|---------------------|
| Type of packaging | packed in cardboard |
|-------------------|---------------------|

MSTB 2,5/ 9-STZ - PCB connector



1758995

<https://www.phoenixcontact.com/us/products/1758995>

Approvals

To download certificates, visit the product detail page: <https://www.phoenixcontact.com/us/products/1758995>

|  CSA Approval ID: 13631 | | | | |
|--|-----------------------|-----------------------|-------------------|-----------------------------|
| | Nominal voltage U_N | Nominal current I_N | Cross section AWG | Cross section mm^2 |
| B | | | | |
| | 300 V | 15 A | 28 - 12 | - |
| D | | | | |
| | 300 V | 10 A | 28 - 12 | - |

|  cULus Recognized Approval ID: E60425-19931011 | | | | |
|---|-----------------------|-----------------------|-------------------|-----------------------------|
| | Nominal voltage U_N | Nominal current I_N | Cross section AWG | Cross section mm^2 |
| B | | | | |
| | 300 V | 15 A | 30 - 12 | - |
| D | | | | |
| | 300 V | 10 A | 30 - 12 | - |

|  VDE Zeichengenehmigung Approval ID: 40004701 | | | | |
|--|-----------------------|-----------------------|-------------------|-----------------------------|
| | Nominal voltage U_N | Nominal current I_N | Cross section AWG | Cross section mm^2 |
| keine | | | | |
| | 250 V | 12 A | - | 0.2 - 2.5 |

MSTB 2,5/ 9-STZ - PCB connector



1758995

<https://www.phoenixcontact.com/us/products/1758995>

Classifications

ECLASS

| | |
|-------------|----------|
| ECLASS-13.0 | 27460202 |
| ECLASS-15.0 | 27460202 |

ETIM

| | |
|-----------|----------|
| ETIM 10.0 | EC002638 |
|-----------|----------|

UNSPSC

| | |
|-------------|----------|
| UNSPSC 21.0 | 39121400 |
|-------------|----------|

MSTB 2,5/ 9-STZ - PCB connector



1758995

<https://www.phoenixcontact.com/us/products/1758995>

Environmental product compliance

EU RoHS

| | |
|---|--------------------|
| Fulfills EU RoHS substance requirements | Yes, No exemptions |
|---|--------------------|

China RoHS

| | |
|--|--|
| Environment friendly use period (EFUP) | EFUP-E |
| | No hazardous substances above the limits |

EU REACH SVHC

| | |
|-------------------------------------|----------------------------|
| REACH candidate substance (CAS No.) | No substance above 0.1 wt% |
|-------------------------------------|----------------------------|

Phoenix Contact 2026 © - all rights reserved
<https://www.phoenixcontact.com>

Phoenix Contact USA
586 Fulling Mill Road
Middletown, PA 17057, United States
(+717) 944-1300
info@phoenixcon.com