

ISPC 16/ 2-ST-10,16 - PCB connector

1748545

<https://www.phoenixcontact.com/us/products/1748545>

Please be informed that the data shown in this PDF document is generated from our online catalog. Please find the complete data in the user documentation. Our general terms of use for downloads are valid.

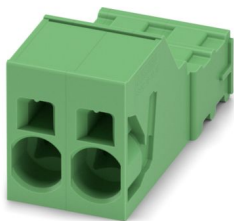

PCB connector, nominal cross section: 16 mm², color: green, nominal current: 76 A, rated voltage (III/2): 1000 V, contact surface: Ag, contact connection type: Pin, number of potentials: 2, number of rows: 1, number of positions: 2, number of connections: 2, product range: ISPC 16/..-ST, pitch: 10.16 mm, connection method: Push-in spring connection, conductor/PCB connection direction: 0 °, locking clip: - without locking clip, plug-in system: COMBICON PC 16, locking: without, mounting method: without, type of packaging: packed in cardboard

Your advantages

- Time saving push-in connection, tools not required
- Defined contact force ensures that contact remains stable over the long term
- Clamping space opened by means of fixed screwdriver enables convenient conductor connection
- Inverted connector with pin contacts for touch-proof device outputs or free-hanging cable/cable connections

Commercial data

Item number	1748545
Packing unit	50 pc
Minimum order quantity	50 pc
Sales key	AA05
Product key	AAEFBB
GTIN	4046356310604
Weight per piece (including packing)	17.462 g
Weight per piece (excluding packing)	17.442 g
Customs tariff number	85366990
Country of origin	IN

ISPC 16/ 2-ST-10,16 - PCB connector



1748545

<https://www.phoenixcontact.com/us/products/1748545>

Technical data

Product properties

Product type	PCB connector
Product family	ISPC 16/..-ST
Product line	COMBICON Connectors XL
Type	Standard
Number of positions	2
Pitch	10.16 mm
Number of connections	2
Number of rows	1
Number of potentials	2
Mounting type	without

Electrical properties

Properties

Nominal current I_N	76 A
Nominal voltage U_N	1000 V
Contact resistance	0.35 mΩ
Rated voltage (III/3)	1000 V
Rated surge voltage (III/3)	8 kV
Rated voltage (III/2)	1000 V
Rated surge voltage (III/2)	8 kV
Rated voltage (II/2)	1000 V
Rated surge voltage (II/2)	6 kV

Connection data

Connection technology

Type	Standard
Connector system	COMBICON PC 16
Nominal cross section	16 mm ²
Contact connection type	Pin

Interlock

Locking type	without
Mounting type	without

Conductor connection

Connection method	Push-in spring connection
Conductor/PCB connection direction	0 °
Conductor cross-section rigid	0.75 mm ² ... 16 mm ²
Conductor cross-section flexible	0.75 mm ² ... 16 mm ²
Conductor cross-section AWG	18 ... 4

ISPC 16/ 2-ST-10,16 - PCB connector



1748545

<https://www.phoenixcontact.com/us/products/1748545>

Conductor cross-section, flexible, with ferrule, without plastic sleeve	0.75 mm ² ... 16 mm ²
Conductor cross-section, flexible, with ferrule, with plastic sleeve	0.75 mm ² ... 10 mm ²
2 conductors with same cross section, rigid	0.75 mm ² ... 6 mm ²
2 conductors with same cross section, flexible	0.75 mm ² ... 6 mm ²
2 conductors with the same cross section, flexible, with TWIN ferrule with plastic sleeve	0.75 mm ² ... 4 mm ²
Cylindrical gauge a x b / diameter	- / 5.4 mm
Stripping length	18 mm

Material specifications

Material data - contact

Note	WEEE/RoHS-compliant, free of whiskers according to IEC 60068-2-82/JEDEC JESD 201
Contact material	Cu alloy
Surface characteristics	Electroplated silver
Metal surface terminal point (top layer)	Silver (4 µm - 8 µm Ag)
Metal surface contact area (top layer)	Silver (4 µm - 8 µm Ag)

Material data - housing

Color (Housing)	green (6021)
Insulating material	PA
Insulating material group	I
CTI according to IEC 60112	600
Flammability rating according to UL 94	V0
Glow wire flammability index GWFI according to EN 60695-2-12	850
Glow wire ignition temperature GWIT according to EN 60695-2-13	775
Temperature for the ball pressure test according to EN 60695-10-2	125 °C

Dimensions

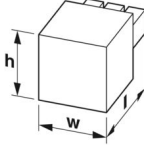
Dimensional drawing	
Pitch	10.16 mm
Width [w]	23.36 mm
Height [h]	25.1 mm
Length [l]	45.1 mm

Notes

Notes on operation	In accordance with IEC 61984, COMBICON connectors have no switching power (COC). During designated use, they must not be plugged in or disconnected when carrying voltage or under load.
--------------------	--

Mechanical tests

Conductor connection

Specification	IEC 60999-1:1999-11
Result	Test passed

Test for conductor damage and slackening

Specification	IEC 60999-1:1999-11
Result	Test passed

Repeated connection and disconnection

Specification	IEC 60999-1:1999-11
Result	Test passed

Pull-out test

Specification	IEC 60999-1:1999-11
Conductor cross-section/conductor type/tractive force setpoint/actual value	0.75 mm ² / solid / > 30 N
	0.75 mm ² / flexible / > 30 N
	16 mm ² / solid / > 100 N
	16 mm ² / flexible / > 100 N

Insertion and withdrawal forces

Specification	IEC 60512-13-2:2006-02
Result	Test passed
No. of cycles	50
Insertion strength per pos. approx.	10 N
Withdraw strength per pos. approx.	8 N

Resistance of inscriptions

Specification	IEC 60068-2-70:1995-12
Result	Test passed

Polarization and coding

Specification	IEC 60512-13-5:2006-02
Result	Test passed

Visual inspection

Specification	IEC 60512-1-1:2002-02
Result	Test passed

Dimension check

Specification	IEC 60512-1-2:2002-02
Result	Test passed

Environmental and real-life conditions

Durability test

Specification	IEC 60512-9-1:2010-03
---------------	-----------------------

ISPC 16/ 2-ST-10,16 - PCB connector



1748545

<https://www.phoenixcontact.com/us/products/1748545>

Impulse withstand voltage at sea level	9.8 kV
Contact resistance R ₁	0.35 mΩ
Contact resistance R ₂	0.34 mΩ
Insertion/withdrawal cycles	50
Insulation resistance, neighboring positions	> 5 MΩ

Climatic test

Specification	ISO 6988:1985-02
Corrosive stress	0.2 dm ³ SO ₂ on 300 dm ³ /40 °C/1 cycle
Thermal stress	100 °C/168 h
Power-frequency withstand voltage	4.26 kV

Vibration test

Specification	IEC 60068-2-6:2007-12
Frequency	10 - 150 - 10 Hz
Sweep speed	1 octave/min
Amplitude	0.35 mm (10 Hz ... 60.1 Hz)
Acceleration	5g (60.1 Hz ... 150 Hz)
Test duration per axis	2.5 h
Test directions	X-, Y- and Z-axis

Ambient conditions

Ambient temperature (storage/transport)	-40 °C ... 70 °C
Relative humidity (storage/transport)	30 % ... 70 %
Ambient temperature (assembly)	-5 °C ... 100 °C
Ambient temperature (operation)	-40 °C ... 100 °C (dependent on the derating curve)

Electrical tests

Thermal test | Test group C

Specification	IEC 60512-5-1:2002-02
Tested number of positions	9

Insulation resistance

Specification	IEC 60512-3-1:2002-02
Insulation resistance, neighboring positions	> 5 MΩ

Temperature cycles

Specification	IEC 60999-1:1999-11
Result	Test passed

Air clearances and creepage distances |

Specification	IEC 60664-1:2007-04
Insulating material group	I
Comparative tracking index (IEC 60112)	CTI 600
Rated insulation voltage (III/3)	1000 V
Rated surge voltage (III/3)	8 kV

ISPC 16/ 2-ST-10,16 - PCB connector



1748545

<https://www.phoenixcontact.com/us/products/1748545>

minimum clearance value - non-homogenous field (III/3)	8 mm
minimum creepage distance (III/3)	12.5 mm
Rated insulation voltage (III/2)	1000 V
Rated surge voltage (III/2)	8 kV
minimum clearance value - non-homogenous field (III/2)	8 mm
minimum creepage distance (III/2)	8 mm
Rated insulation voltage (II/2)	1000 V
Rated surge voltage (II/2)	6 kV
minimum clearance value - non-homogenous field (II/2)	5.5 mm
minimum creepage distance (II/2)	5.5 mm

Packaging specifications

Type of packaging	packed in cardboard
-------------------	---------------------

Drawings

Diagram

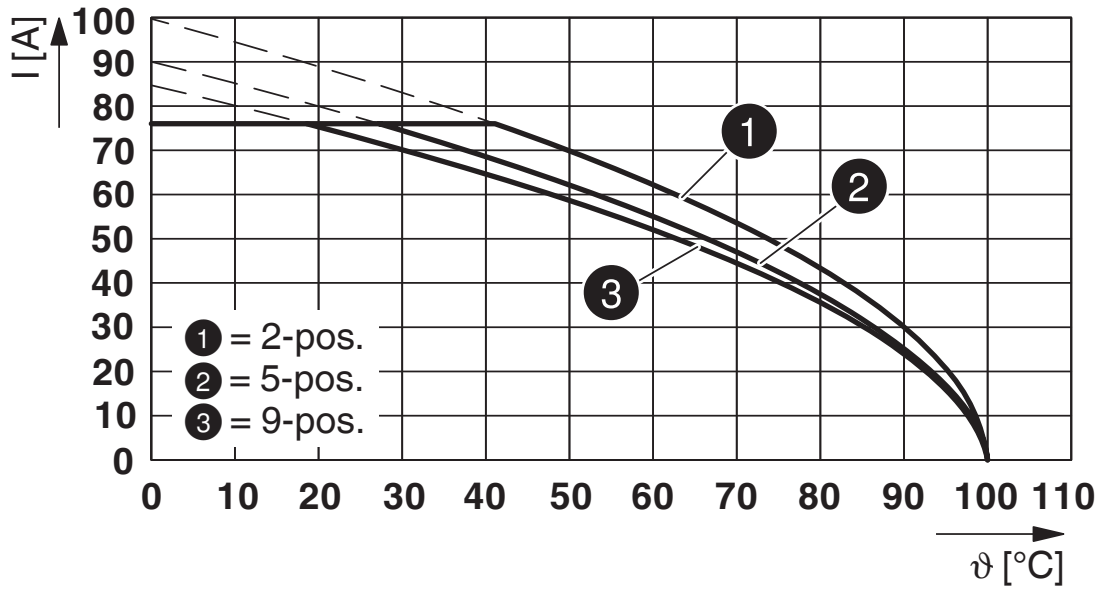

Type: ISPC 16/...-ST-10,16 with DFK-IPC 16/...-ST-10,16

Diagram

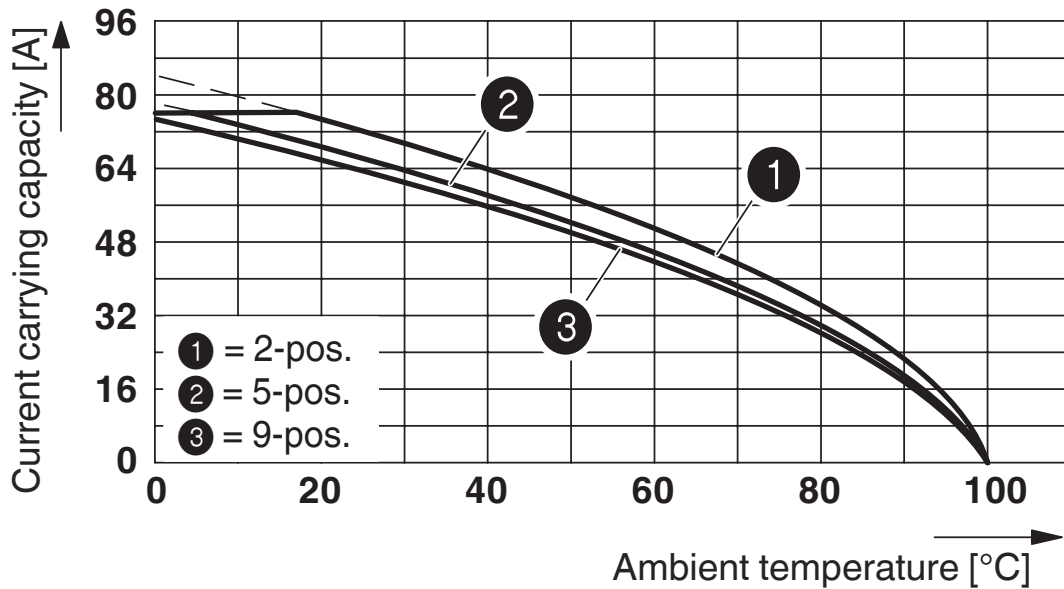

Derating curve for: ISPC 16/...-ST-10,16 with IPCV 16/...-G-10,16

1748545

<https://www.phoenixcontact.com/us/products/1748545>

Diagram

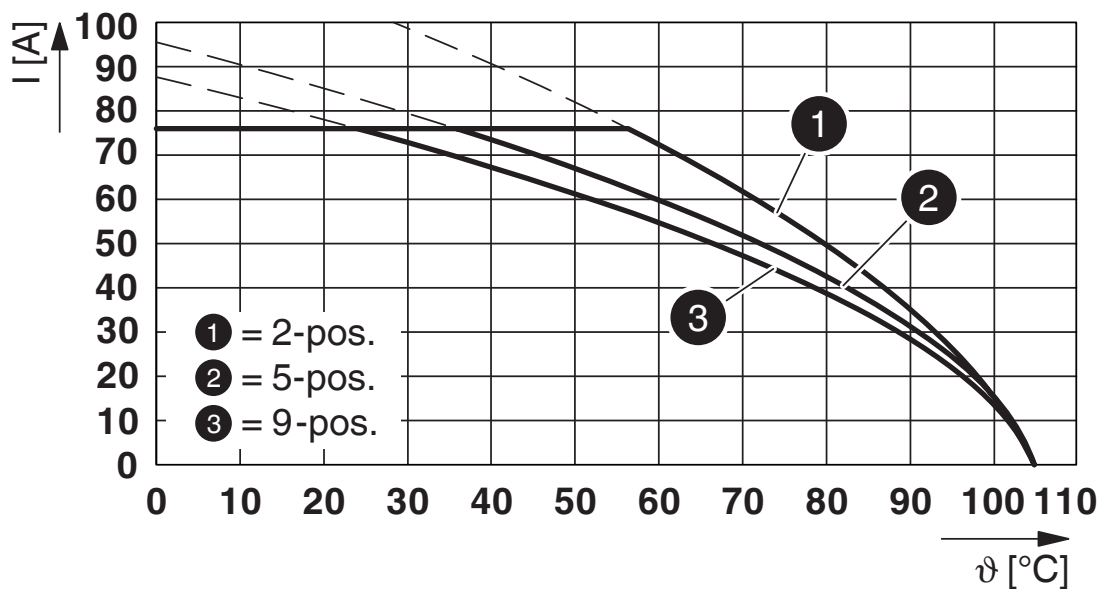

Type: SPC 16/...-ST-10,16 with ISPC 16/...-ST-10,16

Diagram

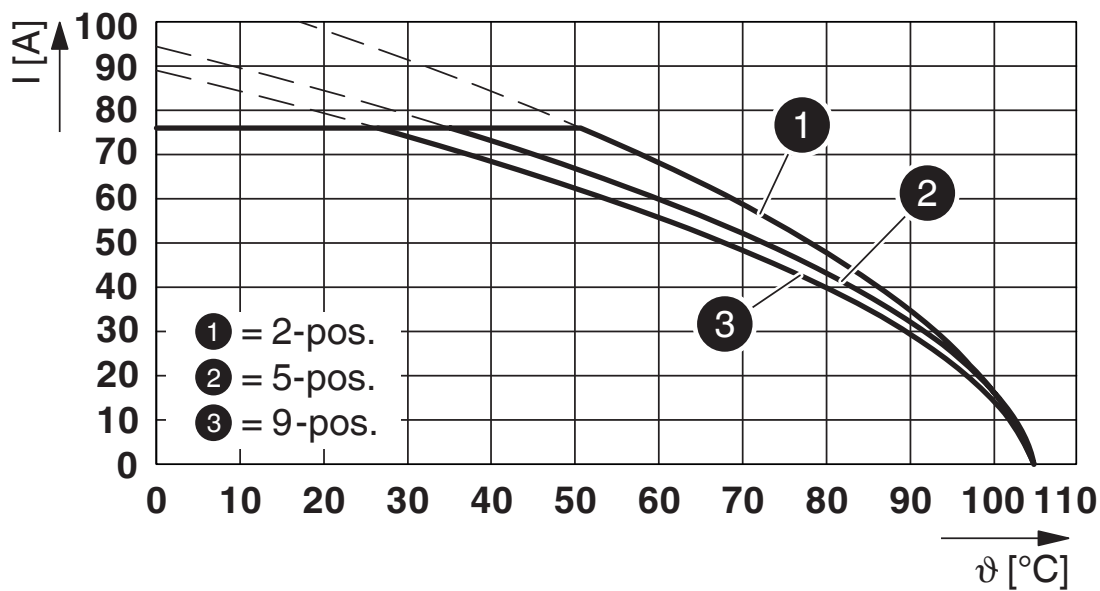

Type: PC 16/...-ST-10,16 with ISPC 16/...-ST-10,16

1748545

<https://www.phoenixcontact.com/us/products/1748545>

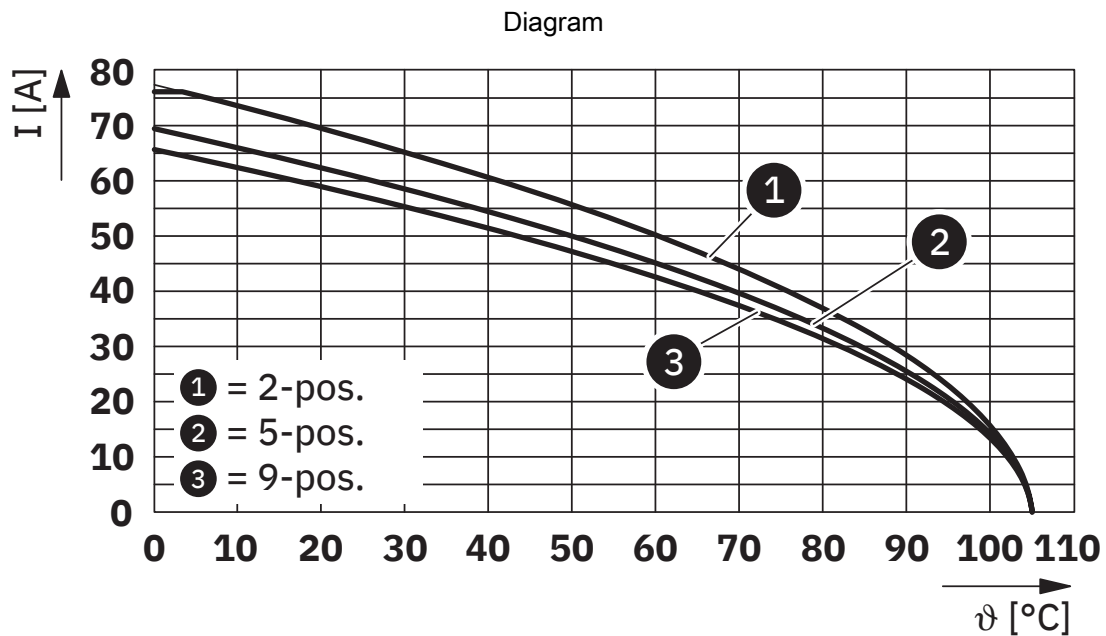

Type: ISPC 16/...-ST-10,16 with IPC 16/...-G-10,16

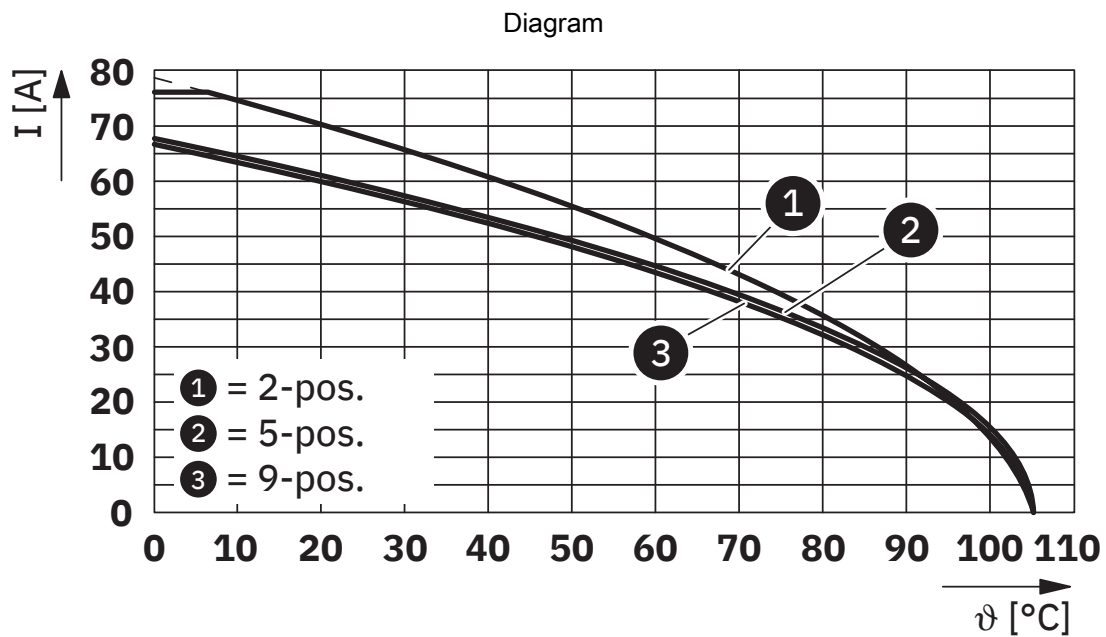

Type: ISPC 16/...-ST-10,16 with IPC 16/...-GU-10,16

ISPC 16/ 2-ST-10,16 - PCB connector



1748545

<https://www.phoenixcontact.com/us/products/1748545>

Approvals

To download certificates, visit the product detail page: <https://www.phoenixcontact.com/us/products/1748545>

 cULus Recognized Approval ID: E60425-20040202				
	Nominal voltage U_N	Nominal current I_N	Cross section AWG	Cross section mm^2
B	600 V	66 A	20 - 4	-
C	600 V	66 A	20 - 4	-

 VDE approval of drawings Approval ID: 40055586				
	Nominal voltage U_N	Nominal current I_N	Cross section AWG	Cross section mm^2
keine	1000 V	76 A	-	0.75 - 16

ISPC 16/ 2-ST-10,16 - PCB connector



1748545

<https://www.phoenixcontact.com/us/products/1748545>

Classifications

ECLASS

ECLASS-13.0	27460202
ECLASS-15.0	27460202

ETIM

ETIM 10.0	EC002638
-----------	----------

UNSPSC

UNSPSC 21.0	39121400
-------------	----------

ISPC 16/ 2-ST-10,16 - PCB connector



1748545

<https://www.phoenixcontact.com/us/products/1748545>

Environmental product compliance

EU RoHS

Fulfills EU RoHS substance requirements	Yes, No exemptions
---	--------------------

China RoHS

Environment friendly use period (EFUP)	EFUP-E
	No hazardous substances above the limits

EU REACH SVHC

REACH candidate substance (CAS No.)	No substance above 0.1 wt%
-------------------------------------	----------------------------

EF3.1 Climate Change

CO2e kg	0.104 kg CO2e
---------	---------------

Phoenix Contact 2026 © - all rights reserved
<https://www.phoenixcontact.com>

Phoenix Contact USA
586 Fulling Mill Road
Middletown, PA 17057, United States
(+717) 944-1300
info@phoenixcon.com