

# PST 1,0/ 7-H-3,5 - Pin strip

1737064

<https://www.phoenixcontact.com/us/products/1737064>

Please be informed that the data shown in this PDF document is generated from our online catalog. Please find the complete data in the user documentation. Our general terms of use for downloads are valid.



The figure shows a 10-position version of the product

Pin strip, nominal cross section: 1.5 mm<sup>2</sup>, color: black, nominal current: 8 A (depends on the plug used), rated voltage (III/2): 250 V, contact surface: Sn, contact connection type: Pin, number of potentials: 7, number of rows: 1, number of positions: 7, number of connections: 7, product range: PST 1,0/..-H, pitch: 3.5 mm, mounting: THR soldering / wave soldering, pin layout: Linear pinning, solder pin [P]: 6.6 mm, number of solder pins per potential: 1, plug-in system: COMBICON PST 1,0, locking: without, mounting method: without, type of packaging: packed in cardboard, The maximum current depends on the plug used. The lower of the two current values apply for plug and pin strip. The pin strip is made of highly temperature resistant plastic and is thus suitable for the reflow process.

## Your advantages

- Suitable for wave and reflow soldering processes
- Optimum pin geometry for all COMBICON pin strip connectors

## Commercial data

Item number	1737064
Packing unit	50 pc
Minimum order quantity	50 pc
Sales key	AA02
Product key	AABTKB
GTIN	4046356183475
Weight per piece (including packing)	1.006 g
Weight per piece (excluding packing)	0.99 g
Customs tariff number	85366930
Country of origin	SK

# PST 1,0/ 7-H-3,5 - Pin strip



1737064

<https://www.phoenixcontact.com/us/products/1737064>

## Technical data

### Product properties

Product type	Pin strip
Product family	PST 1,0/..-H
Product line	COMBICON Connectors S
Type	Pin strip
Number of positions	7
Pitch	3.5 mm
Number of connections	7
Number of rows	1
Number of potentials	7
Mounting type	without
Pin layout	Linear pinning
Solder pins per potential	1

### Electrical properties

#### Properties

Nominal current $I_N$	8 A (depends on the plug used)
Nominal voltage $U_N$	250 V
Rated voltage (III/3)	160 V
Rated surge voltage (III/3)	2.5 kV
Rated voltage (III/2)	250 V
Rated surge voltage (III/2)	2.5 kV
Rated voltage (II/2)	250 V
Rated surge voltage (II/2)	2.5 kV

### Mounting

Mounting type	THR soldering / wave soldering
Pin layout	Linear pinning

### Material specifications

#### Material data - contact

Note	WEEE/RoHS-compliant, free of whiskers according to IEC 60068-2-82/JEDEC JESD 201
Contact material	Cu alloy
Surface characteristics	Tin-plated
Metal surface contact area (top layer)	Tin (3 $\mu\text{m}$ - 5 $\mu\text{m}$ Sn)
Metal surface contact area (middle layer)	Nickel (1 $\mu\text{m}$ - 3 $\mu\text{m}$ Ni)
Metal surface soldering area (top layer)	Tin (3 $\mu\text{m}$ - 5 $\mu\text{m}$ Sn)
Metal surface soldering area (middle layer)	Nickel (1 $\mu\text{m}$ - 3 $\mu\text{m}$ Ni)

#### Material data - housing

# PST 1,0/ 7-H-3,5 - Pin strip

1737064

<https://www.phoenixcontact.com/us/products/1737064>

Color (Housing)	black (9005)
Insulating material	PA
Insulating material group	IIIa
CTI according to IEC 60112	250
Flammability rating according to UL 94	V0
Glow wire flammability index GWFI according to EN 60695-2-12	850
Glow wire ignition temperature GWIT according to EN 60695-2-13	775
Temperature for the ball pressure test according to EN 60695-10-2	125 °C

## Dimensions

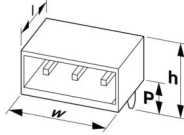
Dimensional drawing	
Pitch	3.5 mm
Width [w]	24.5 mm
Height [h]	9.4 mm
Length [l]	10.5 mm
Installed height	2.8 mm
Solder pin length [P]	6.6 mm
Pin dimensions	ø 1 mm

## PCB design

Hole diameter	1.2 mm
---------------	--------

## Electrical tests

### Air clearances and creepage distances |

Specification	IEC 60664-1:2007-04
Insulating material group	IIIa
Comparative tracking index (IEC 60112)	CTI 250
Rated insulation voltage (III/3)	160 V
Rated surge voltage (III/3)	2.5 kV
minimum clearance value - non-homogenous field (III/3)	1.5 mm
minimum creepage distance (III/3)	2.5 mm
Rated insulation voltage (III/2)	250 V
Rated surge voltage (III/2)	2.5 kV
minimum clearance value - non-homogenous field (III/2)	1.5 mm
minimum creepage distance (III/2)	2.5 mm
Rated insulation voltage (II/2)	250 V
Rated surge voltage (II/2)	2.5 kV
minimum clearance value - non-homogenous field (II/2)	1.5 mm

# PST 1,0/ 7-H-3,5 - Pin strip



1737064

<https://www.phoenixcontact.com/us/products/1737064>

minimum creepage distance (II/2)	2.5 mm
----------------------------------	--------

## Environmental and real-life conditions

### Ambient conditions

Ambient temperature (storage/transport)	-40 °C ... 70 °C
Relative humidity (storage/transport)	30 % ... 70 %
Ambient temperature (assembly)	-5 °C ... 100 °C
Ambient temperature (operation)	-40 °C ... 100 °C (dependent on the derating curve)

### Ambient conditions

Ambient temperature (operation)	-40 °C ... 100 °C (dependent on the derating curve)
Ambient temperature (storage/transport)	-40 °C ... 70 °C
Relative humidity (storage/transport)	30 % ... 70 %
Ambient temperature (assembly)	-5 °C ... 100 °C

## Packaging specifications

Type of packaging	packed in cardboard
-------------------	---------------------

# PST 1,0/ 7-H-3,5 - Pin strip

1737064

<https://www.phoenixcontact.com/us/products/1737064>

## Drawings

Dimensional drawing

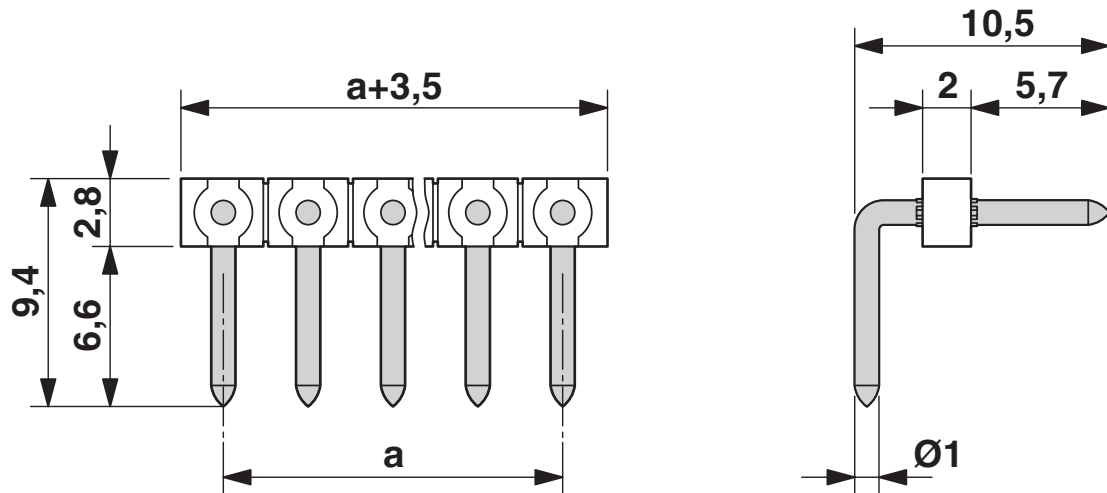

Drilling plan/solder pad geometry



# PST 1,0/ 7-H-3,5 - Pin strip

1737064

<https://www.phoenixcontact.com/us/products/1737064>



## Approvals

To download certificates, visit the product detail page: <https://www.phoenixcontact.com/us/products/1737064>

 <b>cULus Recognized</b> Approval ID: E60425-20030211				
	Nominal voltage $U_N$	Nominal current $I_N$	Cross section AWG	Cross section $\text{mm}^2$
B				
	300 V	10 A	-	-

# PST 1,0/ 7-H-3,5 - Pin strip

1737064

<https://www.phoenixcontact.com/us/products/1737064>



## Classifications

### ECLASS

ECLASS-13.0	27460201
ECLASS-15.0	27460201

### ETIM

ETIM 10.0	EC002637
-----------	----------

### UNSPSC

UNSPSC 21.0	39121400
-------------	----------

# PST 1,0/ 7-H-3,5 - Pin strip



1737064

<https://www.phoenixcontact.com/us/products/1737064>

## Environmental product compliance

### EU RoHS

Fulfills EU RoHS substance requirements	Yes, No exemptions
---	--------------------

### China RoHS

Environment friendly use period (EFUP)	EFUP-E
	No hazardous substances above the limits

### EU REACH SVHC

REACH candidate substance (CAS No.)	No substance above 0.1 wt%
-------------------------------------	----------------------------

Phoenix Contact 2026 © - all rights reserved  
<https://www.phoenixcontact.com>

Phoenix Contact USA  
586 Fulling Mill Road  
Middletown, PA 17057, United States  
(+717) 944-1300  
[info@phoenixcon.com](mailto:info@phoenixcon.com)