

# MKDSP 1,5/ 6-5,08 - PCB terminal block

1730162

<https://www.phoenixcontact.com/us/products/1730162>

Please be informed that the data shown in this PDF document is generated from our online catalog. Please find the complete data in the user documentation. Our general terms of use for downloads are valid.



PCB terminal block, nominal current: 17.5 A, rated voltage (III/2): 400 V, nominal cross section: 1.5 mm<sup>2</sup>, number of potentials: 6, number of rows: 1, number of positions per row: 6, product range: MKDSP 1,5, pitch: 5.08 mm, connection method: Screw connection with tension sleeve, screw head form: L Slotted, mounting: Wave soldering, conductor/PCB connection direction: 0 °, color: green, Pin layout: Linear pinning, Solder pin [P]: 3.5 mm, number of solder pins per potential: 1, type of packaging: packed in cardboard

## Your advantages

- Well-known connection principle allows worldwide use
- Low temperature rise, thanks to maximum contact force
- Allows connection of two conductors
- Quick and convenient testing using integrated test option
- The latching on the side enables various numbers of positions to be combined

## Commercial data

Item number	1730162
Packing unit	50 pc
Minimum order quantity	50 pc
Sales key	AA12
Product key	AALFGP
GTIN	4017918026264
Weight per piece (including packing)	8.67 g
Weight per piece (excluding packing)	8.21 g
Customs tariff number	85369010
Country of origin	DE

# MKDSP 1,5/ 6-5,08 - PCB terminal block



1730162

<https://www.phoenixcontact.com/us/products/1730162>

## Technical data

### Product properties

Product type	PCB terminal block
Product family	MKDSP 1,5
Product line	COMBICON Terminals S
Type	PC termination block
Number of positions	6
Pitch	5.08 mm
Number of connections	6
Number of rows	1
Number of potentials	6
Pin layout	Linear pinning
Solder pins per potential	1

### Electrical properties

#### Properties

Nominal current $I_N$	17.5 A
Nominal voltage $U_N$	400 V
Rated voltage (III/3)	250 V
Rated surge voltage (III/3)	4 kV
Rated voltage (III/2)	400 V
Rated surge voltage (III/2)	4 kV
Rated voltage (II/2)	630 V
Rated surge voltage (II/2)	4 kV

### Connection data

#### Connection technology

Type	PC termination block
Nominal cross section	1.5 mm <sup>2</sup>

#### Conductor connection

Connection method	Screw connection with tension sleeve
Conductor cross-section rigid	0.14 mm <sup>2</sup> ... 2.5 mm <sup>2</sup>
Conductor cross-section flexible	0.14 mm <sup>2</sup> ... 1.5 mm <sup>2</sup>
Conductor cross-section AWG	26 ... 14
Conductor cross-section, flexible, with ferrule, without plastic sleeve	0.25 mm <sup>2</sup> ... 1.5 mm <sup>2</sup>
Conductor cross-section, flexible, with ferrule, with plastic sleeve	0.25 mm <sup>2</sup> ... 1.5 mm <sup>2</sup>
2 conductors with same cross section, rigid	0.14 mm <sup>2</sup> ... 1 mm <sup>2</sup>
2 conductors with same cross section, flexible	0.14 mm <sup>2</sup> ... 0.75 mm <sup>2</sup>
2 conductors with same cross section, flexible, with ferrule without plastic sleeve	0.25 mm <sup>2</sup> ... 0.5 mm <sup>2</sup>

# MKDSP 1,5/ 6-5,08 - PCB terminal block

1730162

<https://www.phoenixcontact.com/us/products/1730162>

2 conductors with the same cross section, flexible, with TWIN ferrule with plastic sleeve	0.5 mm <sup>2</sup> ... 1 mm <sup>2</sup>
Stripping length	7 mm
Drive form screw head	Slotted (L)
Tightening torque	0.5 Nm ... 0.6 Nm

## Mounting

Mounting type	Wave soldering
Pin layout	Linear pinning

## Material specifications

### Material data - contact

Note	WEEE/RoHS-compliant, free of whiskers according to IEC 60068-2-82/JEDEC JESD 201
Contact material	Cu alloy
Surface characteristics	Tin-plated
Metal surface terminal point (top layer)	Tin (4 µm - 8 µm Sn)
Metal surface terminal point (middle layer)	Nickel (1.5 µm - 4 µm Ni)
Metal surface soldering area (top layer)	Tin (4 µm - 8 µm Sn)
Metal surface soldering area (middle layer)	Nickel (1.5 µm - 4 µm Ni)

### Material data - housing

Color (Housing)	green (6021)
Insulating material	PA
Insulating material group	I
CTI according to IEC 60112	600
Flammability rating according to UL 94	V2

## Notes

Note on application	For safe conductor connection, always adhere to a defined tightening torque. Particularly in the case of PCB terminal blocks with two or three positions, the individual solder pin for each contact point cannot compensate for this. That is why the terminal blocks must be supported during conductor connection (held with one hand, support on the housing).
---------------------	--

## Dimensions

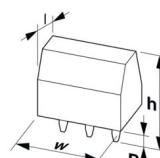
Dimensional drawing	
Pitch	5.08 mm
Width [w]	30.48 mm
Height [h]	17.3 mm
Length [l]	11.15 mm

# MKDSP 1,5/ 6-5,08 - PCB terminal block



1730162

<https://www.phoenixcontact.com/us/products/1730162>

Installed height	13.8 mm
Solder pin length [P]	3.5 mm
Pin dimensions	0.9 x 0.9 mm

## PCB design

Hole diameter	1.3 mm
---------------	--------

## Mechanical tests

### Test for conductor damage and slackening

Specification	IEC 60999-1:1999-11
Result	Test passed

### Pull-out test

Specification	IEC 60999-1:1999-11
Conductor cross-section/conductor type/tractive force setpoint/actual value	0.14 mm <sup>2</sup> / solid / > 10 N
	0.14 mm <sup>2</sup> / flexible / > 10 N
	2.5 mm <sup>2</sup> / solid / > 50 N
	1.5 mm <sup>2</sup> / flexible / > 40 N

## Electrical tests

### Temperature-rise test

Specification	IEC 60947-7-4:2019-01
Requirement temperature-rise test	The sum of ambient temperature and temperature rise of the PCB terminal block shall not exceed the upper limiting temperature.

### Short-time withstand current

Specification	IEC 60947-7-4:2019-01
---------------	-----------------------

### Insulation resistance

Specification	IEC 60512-3-1:2002-02
Insulation resistance, neighboring positions	> 5 MΩ

### Air clearances and creepage distances |

Specification	IEC 60947-1:2007-06 + A1:2010-12 + A2:2014-09
Insulating material group	I
Comparative tracking index (IEC 60112)	CTI 600
Rated insulation voltage (III/3)	250 V
Rated surge voltage (III/3)	4 kV
minimum clearance value - non-homogenous field (III/3)	3 mm
minimum creepage distance (III/3)	3.2 mm
Note on connection cross section	With connected conductor 2.5 mm <sup>2</sup> (solid).
Rated insulation voltage (III/2)	400 V
Rated surge voltage (III/2)	4 kV
minimum clearance value - non-homogenous field (III/2)	3 mm
minimum creepage distance (III/2)	3 mm

# MKDSP 1,5/ 6-5,08 - PCB terminal block



1730162

<https://www.phoenixcontact.com/us/products/1730162>

Rated insulation voltage (II/2)	630 V
Rated surge voltage (II/2)	4 kV
minimum clearance value - non-homogenous field (II/2)	3 mm
minimum creepage distance (II/2)	3.2 mm

## Environmental and real-life conditions

### Vibration test

Specification	IEC 60068-2-6:2007-12
Frequency	10 - 150 - 10 Hz
Sweep speed	1 octave/min
Amplitude	0.35 mm (10 Hz ... 60.1 Hz)
Acceleration	5g (60.1 Hz ... 150 Hz)
Test duration per axis	2.5 h
Test directions	X-, Y- and Z-axis

### Glow-wire test

Specification	IEC 60695-2-10:2013-04
Temperature	850 °C
Time of exposure	5 s

### Aging

Specification	IEC 60947-7-4:2019-01
---------------	-----------------------

### Ambient conditions

Ambient temperature (storage/transport)	-40 °C ... 70 °C
Relative humidity (storage/transport)	30 % ... 70 %
Ambient temperature (assembly)	-5 °C ... 100 °C
Ambient temperature (operation)	-40 °C ... 105 °C (Depending on the current carrying capacity/derating curve)

## Packaging specifications

Type of packaging	packed in cardboard
-------------------	---------------------

# MKDSP 1,5/ 6-5,08 - PCB terminal block

1730162

<https://www.phoenixcontact.com/us/products/1730162>

## Drawings

Dimensional drawing



Diagram



Type: MKDSP 1,5/...-5,08

# MKDSP 1,5/ 6-5,08 - PCB terminal block

1730162

<https://www.phoenixcontact.com/us/products/1730162>



Drilling plan/solder pad geometry



# MKDSP 1,5/ 6-5,08 - PCB terminal block



1730162

<https://www.phoenixcontact.com/us/products/1730162>

## Approvals

To download certificates, visit the product detail page: <https://www.phoenixcontact.com/us/products/1730162>

 <b>CSA</b> Approval ID: 13631				
	Nominal voltage $U_N$	Nominal current $I_N$	Cross section AWG	Cross section $\text{mm}^2$
B				
	300 V	10 A	28 - 14	-
D				
	300 V	10 A	28 - 14	-

 <b>cULus Recognized</b> Approval ID: E60425-19770427				
	Nominal voltage $U_N$	Nominal current $I_N$	Cross section AWG	Cross section $\text{mm}^2$
B				
	300 V	10 A	30 - 14	-
D				
	300 V	10 A	30 - 14	-

 <b>VDE approval of drawings</b> Approval ID: 40055535				
	Nominal voltage $U_N$	Nominal current $I_N$	Cross section AWG	Cross section $\text{mm}^2$
keine				
	400 V	22 A	-	0.2 - 2.5

# MKDSP 1,5/ 6-5,08 - PCB terminal block



1730162

<https://www.phoenixcontact.com/us/products/1730162>

## Classifications

### ECLASS

ECLASS-13.0	27460101
ECLASS-15.0	27460101

### ETIM

ETIM 10.0	EC002643
-----------	----------

### UNSPSC

UNSPSC 21.0	39121400
-------------	----------

# MKDSP 1,5/ 6-5,08 - PCB terminal block



1730162

<https://www.phoenixcontact.com/us/products/1730162>

## Environmental product compliance

### EU RoHS

Fulfills EU RoHS substance requirements	Yes, No exemptions
---	--------------------

### China RoHS

Environment friendly use period (EFUP)	EFUP-E
	No hazardous substances above the limits

### EU REACH SVHC

REACH candidate substance (CAS No.)	No substance above 0.1 wt%
-------------------------------------	----------------------------

### EF3.1 Climate Change

CO2e kg	0.047 kg CO2e
---------	---------------

Phoenix Contact 2026 © - all rights reserved  
<https://www.phoenixcontact.com>

Phoenix Contact USA  
586 Fulling Mill Road  
Middletown, PA 17057, United States  
(+717) 944-1300  
[info@phoenixcon.com](mailto:info@phoenixcon.com)