

PTDA 1,5/16-PH-3,5 - PCB connector



1725289

<https://www.phoenixcontact.com/us/products/1725289>

Please be informed that the data shown in this PDF document is generated from our online catalog. Please find the complete data in the user documentation. Our general terms of use for downloads are valid.



PCB connector, nominal cross section: 1.5 mm², color: green, nominal current: 8 A, rated voltage (III/2): 240 V, contact surface: Sn, contact connection type: Socket, number of potentials: 16, number of rows: 1, number of positions: 16, number of connections: 32, product range: PTDA 1,5/..-PH, pitch: 3.5 mm, connection method: Push-in spring connection, conductor/PCB connection direction: 45 °, pin layout: Linear double pinning, plug-in system: COMBICON PST 1,0, locking: without, mounting method: without, type of packaging: packed in cardboard



Your advantages

- Time saving push-in connection, tools not required
- Defined contact force ensures that contact remains stable over the long term
- Potentials can be easily looped through – ideal for BUS applications
- Quick and convenient testing using integrated test option
- Rounded type for individual device design

Commercial data

Item number	1725289
Packing unit	50 pc
Minimum order quantity	50 pc
Sales key	AA02
Product key	AABFPA
GTIN	4046356129244
Weight per piece (including packing)	20.122 g
Weight per piece (excluding packing)	19.305 g
Customs tariff number	85366990
Country of origin	PL

PTDA 1,5/16-PH-3,5 - PCB connector



1725289

<https://www.phoenixcontact.com/us/products/1725289>

Technical data

Product properties

Product type	PCB connector
Product family	PTDA 1,5/..-PH
Product line	COMBICON Connectors S
Type	Plug for pin strip
Number of positions	16
Pitch	3.5 mm
Number of connections	32
Number of rows	1
Number of potentials	16
Mounting type	without
Pin layout	Linear double pinning

Electrical properties

Properties

Nominal current I_N	8 A
Nominal voltage U_N	240 V
Contact resistance	1.8 m Ω
Rated voltage (III/3)	160 V
Rated surge voltage (III/3)	2.5 kV
Rated voltage (III/2)	240 V
Rated surge voltage (III/2)	2.5 kV
Rated voltage (II/2)	400 V
Rated surge voltage (II/2)	2.5 kV

Connection data

Connection technology

Type	Plug for pin strip
Connector system	COMBICON PST 1,0
Nominal cross section	1.5 mm ²
Contact connection type	Socket

Interlock

Locking type	without
Mounting type	without

Conductor connection

Connection method	Push-in spring connection
Conductor/PCB connection direction	45 °
Conductor cross-section rigid	0.2 mm ² ... 1.5 mm ²
Conductor cross-section flexible	0.2 mm ² ... 1.5 mm ²

PTDA 1,5/16-PH-3,5 - PCB connector

1725289

<https://www.phoenixcontact.com/us/products/1725289>

Conductor cross-section AWG	24 ... 16
Conductor cross-section, flexible, with ferrule, without plastic sleeve	0.5 mm ² ... 1.5 mm ²
Conductor cross-section, flexible, with ferrule, with plastic sleeve	0.5 mm ² ... 0.5 mm ²
2 conductors with the same cross section, flexible, with TWIN ferrule with plastic sleeve	0.5 mm ² ... 0.5 mm ²
Stripping length	10 mm

Material specifications

Material data - contact

Note	WEEE/RoHS-compliant, free of whiskers according to IEC 60068-2-82/JEDEC JESD 201
Contact material	Cu alloy
Surface characteristics	hot-dip tin-plated
Metal surface terminal point (top layer)	Tin (4 µm - 8 µm Sn)
Metal surface contact area (top layer)	Tin (4 µm - 8 µm Sn)

Material data - housing

Color (Housing)	green (6021)
Insulating material	PA
Insulating material group	I
CTI according to IEC 60112	600
Flammability rating according to UL 94	V0
Glow wire flammability index GWFI according to EN 60695-2-12	850
Glow wire ignition temperature GWIT according to EN 60695-2-13	775
Temperature for the ball pressure test according to EN 60695-10-2	125 °C

Dimensions

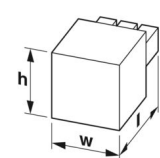
Dimensional drawing	
Pitch	3.5 mm
	3.5 mm
Width [w]	57.4 mm
Height [h]	16 mm
Length [l]	20 mm

Mounting

Pin layout	Linear double pinning
------------	-----------------------

Mechanical tests

PTDA 1,5/16-PH-3,5 - PCB connector



1725289

<https://www.phoenixcontact.com/us/products/1725289>

Conductor connection

Specification	IEC 60999-1:1999-11
Result	Test passed

Test for conductor damage and slackening

Specification	IEC 60999-1:1999-11
Result	Test passed

Repeated connection and disconnection

Specification	IEC 60999-1:1999-11
Result	Test passed

Pull-out test

Specification	IEC 60999-1:1999-11
Conductor cross-section/conductor type/tractive force setpoint/actual value	0.2 mm ² / solid / > 10 N
	0.2 mm ² / flexible / > 10 N
	1.5 mm ² / solid / > 40 N
	1.5 mm ² / flexible / > 40 N

Insertion and withdrawal forces

Specification	IEC 60512-13-2:2006-02
Result	Test passed
No. of cycles	10
Insertion strength per pos. approx.	6 N
Withdraw strength per pos. approx.	5 N

Resistance of inscriptions

Specification	IEC 60068-2-70:1995-12
Result	Test passed

Visual inspection

Specification	IEC 60512-1-1:2002-02
Result	Test passed

Dimension check

Specification	IEC 60512-1-2:2002-02
Result	Test passed

Environmental and real-life conditions

Durability test

Specification	IEC 60512-5:1992-08
Impulse withstand voltage at sea level	2.95 kV
Contact resistance R ₁	1.8 mΩ
Contact resistance R ₂	1.9 mΩ
Insertion/withdrawal cycles	10

Climatic test

PTDA 1,5/16-PH-3,5 - PCB connector



1725289

<https://www.phoenixcontact.com/us/products/1725289>

Specification	ISO 6988:1985-02
Corrosive stress	0.2 dm ³ SO ₂ on 300 dm ³ /40 °C/1 cycle
Thermal stress	100 °C/168 h
Power-frequency withstand voltage	1.39 kV

Vibration test

Specification	IEC 60068-2-6:1995-03
Frequency	10 - 150 - 10 Hz
Sweep speed	1 octave/min
Amplitude	0.35 mm (10 Hz ... 60.1 Hz)
Acceleration	5g (60.1 Hz ... 150 Hz)
Test duration per axis	2.5 h
Test directions	X-, Y- and Z-axis

Ambient conditions

Ambient temperature (storage/transport)	-40 °C ... 70 °C
Relative humidity (storage/transport)	30 % ... 70 %
Ambient temperature (assembly)	-5 °C ... 100 °C
Ambient temperature (operation)	-40 °C ... 100 °C (dependent on the derating curve)

Electrical tests

Thermal test | Test group C

Specification	IEC 60512-5-1:2002-02
Tested number of positions	16

Insulation resistance

Specification	IEC 60512-3-1:2002-02
Insulation resistance, neighboring positions	10 ¹² Ω

Temperature cycles

Specification	IEC 60999-1:1999-11
Result	Test passed

Air clearances and creepage distances |

Specification	IEC 60664-1:2007-04
Insulating material group	I
Comparative tracking index (IEC 60112)	CTI 600
Rated insulation voltage (III/3)	160 V
Rated surge voltage (III/3)	2.5 kV
minimum clearance value - non-homogenous field (III/3)	1.5 mm
minimum creepage distance (III/3)	2 mm
Rated insulation voltage (III/2)	240 V
Rated surge voltage (III/2)	2.5 kV
minimum clearance value - non-homogenous field (III/2)	1.5 mm
minimum creepage distance (III/2)	1.5 mm
Rated insulation voltage (II/2)	400 V

PTDA 1,5/16-PH-3,5 - PCB connector



1725289

<https://www.phoenixcontact.com/us/products/1725289>

Rated surge voltage (II/2)	2.5 kV
minimum clearance value - non-homogenous field (II/2)	1.5 mm
minimum creepage distance (II/2)	2 mm

Packaging specifications

Type of packaging	packed in cardboard
-------------------	---------------------

PTDA 1,5/16-PH-3,5 - PCB connector

1725289

<https://www.phoenixcontact.com/us/products/1725289>

Drawings

Dimensional drawing

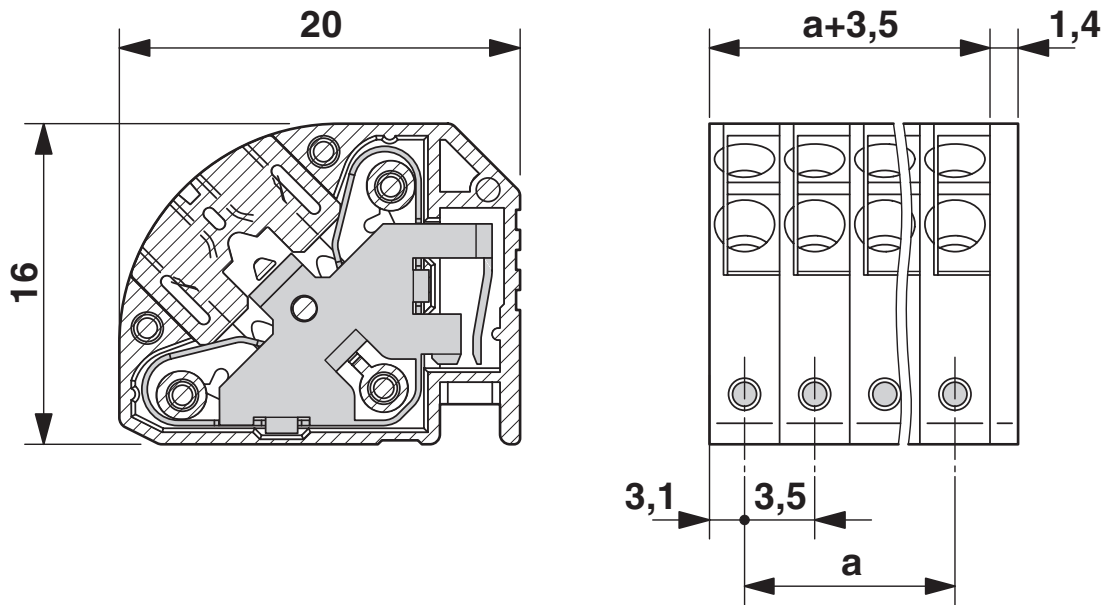

Diagram

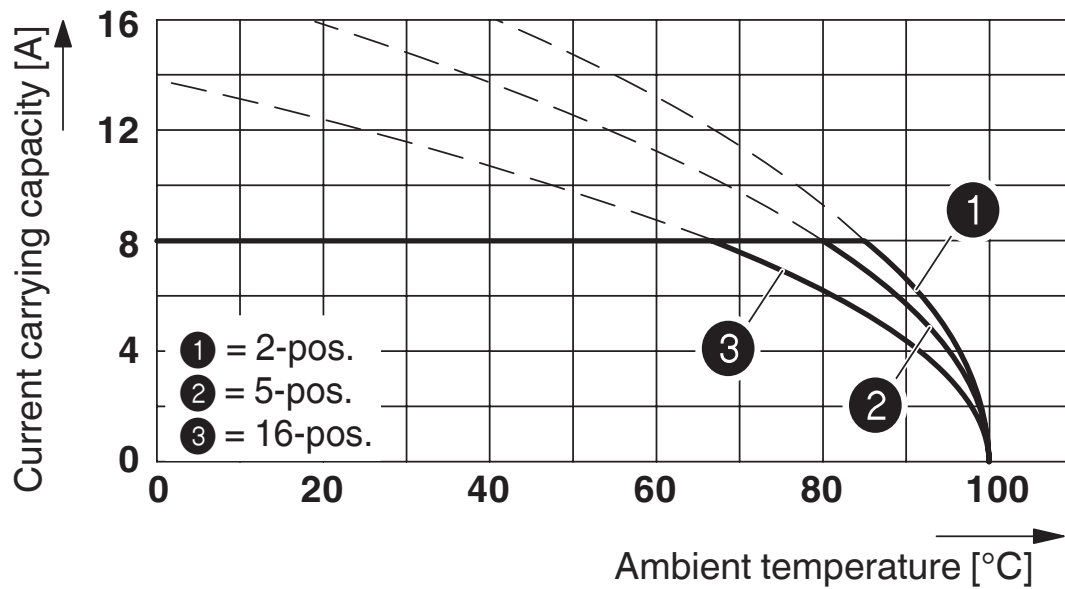

Derating curve for: PTDA 1,5/..-PH-3,5 with PST 1,0/..-3,5

PTDA 1,5/16-PH-3,5 - PCB connector



1725289

<https://www.phoenixcontact.com/us/products/1725289>

Approvals

To download certificates, visit the product detail page: <https://www.phoenixcontact.com/us/products/1725289>

 cULus Recognized Approval ID: E60425-20030211		Nominal voltage U_N	Nominal current I_N	Cross section AWG	Cross section mm^2
B					
with pitch spacer	300 V	10 A	24 - 16	-	
Standard	150 V	10 A	24 - 16	-	
D					
with pitch spacer	300 V	10 A	24 - 16	-	

PTDA 1,5/16-PH-3,5 - PCB connector



1725289

<https://www.phoenixcontact.com/us/products/1725289>

Classifications

ECLASS

ECLASS-13.0	27460202
ECLASS-15.0	27460202

ETIM

ETIM 10.0	EC002638
-----------	----------

UNSPSC

UNSPSC 21.0	39121400
-------------	----------

PTDA 1,5/16-PH-3,5 - PCB connector



1725289

<https://www.phoenixcontact.com/us/products/1725289>

Environmental product compliance

EU RoHS

Fulfills EU RoHS substance requirements	Yes, No exemptions
---	--------------------

China RoHS

Environment friendly use period (EFUP)	EFUP-E
	No hazardous substances above the limits

EU REACH SVHC

REACH candidate substance (CAS No.)	No substance above 0.1 wt%
-------------------------------------	----------------------------

EF3.1 Climate Change

CO2e kg	0.183 kg CO2e
---------	---------------

Phoenix Contact 2026 © - all rights reserved
<https://www.phoenixcontact.com>

Phoenix Contact USA
586 Fulling Mill Road
Middletown, PA 17057, United States
(+717) 944-1300
info@phoenixcon.com