

QC 1,5/12-ST - PCB connector

1718067

<https://www.phoenixcontact.com/us/products/1718067>

Please be informed that the data shown in this PDF document is generated from our online catalog. Please find the complete data in the user documentation. Our general terms of use for downloads are valid.



The figure shows a 10-position version of the product

PCB connector, nominal cross section: 1.5 mm², color: green, nominal current: 12 A, rated voltage (III/2): 630 V, contact surface: Sn, contact connection type: Socket, number of potentials: 12, number of rows: 1, number of positions: 12, number of connections: 12, product range: QC 1,5/..-ST, pitch: 5 mm, connection method: Displacement connection, conductor/PCB connection direction: 0 °, locking clip: - Locking clip, plug-in system: COMBICON MSTB 2,5, locking: without, mounting method: without, type of packaging: packed in cardboard

Your advantages

- Connection without conductor pretreatment for huge time savings
- Can be combined with the MSTB 2,5 range

Commercial data

Item number	1718067
Packing unit	50 pc
Minimum order quantity	50 pc
Note	Made to order (non-returnable)
Sales key	AA03
Product key	AACQCA
GTIN	4046356140331
Weight per piece (including packing)	35.08 g
Weight per piece (excluding packing)	32.188 g
Customs tariff number	85366990
Country of origin	CN

QC 1,5/12-ST - PCB connector



1718067

<https://www.phoenixcontact.com/us/products/1718067>

Technical data

Product properties

Product type	PCB connector
Product family	QC 1,5/...-ST
Product line	COMBICON Connectors M
Type	Standard
Number of positions	12
Pitch	5 mm
Number of connections	12
Number of rows	1
Number of potentials	12
Mounting type	without

Electrical properties

Properties

Nominal current I_N	12 A
Nominal voltage U_N	630 V
Rated voltage (III/3)	500 V
Rated surge voltage (III/3)	6 kV
Rated voltage (III/2)	630 V
Rated surge voltage (III/2)	6 kV
Rated voltage (II/2)	1000 V
Rated surge voltage (II/2)	6 kV

Connection data

Connection technology

Type	Standard
Connector system	COMBICON MSTB 2,5
Nominal cross section	1.5 mm ²
Contact connection type	Socket

Interlock

Locking type	without
Mounting type	without

Conductor connection

Connection method	Displacement connection
Conductor/PCB connection direction	0 °
Conductor cross-section rigid	0.2 mm ² ... 1.5 mm ²
Conductor cross-section flexible	0.2 mm ² ... 1.5 mm ²
Conductor cross-section AWG	24 ... 16

QC 1,5/12-ST - PCB connector

1718067

<https://www.phoenixcontact.com/us/products/1718067>

Material specifications

Material data - contact

Note	WEEE/RoHS-compliant, free of whiskers according to IEC 60068-2-82/JEDEC JESD 201
Contact material	Cu alloy
Surface characteristics	hot-dip tin-plated
Metal surface terminal point (top layer)	Tin (4 µm - 8 µm Sn)
Metal surface contact area (top layer)	Tin (4 µm - 8 µm Sn)

Material data - housing

Color (Housing)	green (6021)
Insulating material	PA
Insulating material group	I
CTI according to IEC 60112	600
Flammability rating according to UL 94	V0
Glow wire flammability index GWFI according to EN 60695-2-12	850
Glow wire ignition temperature GWIT according to EN 60695-2-13	775
Temperature for the ball pressure test according to EN 60695-10-2	125 °C

Material data – actuating element

Color (Actuating element)	orange (2003)
Insulating material	PA
Insulating material group	I
CTI according to IEC 60112	600
Flammability rating according to UL 94	V0
Glow wire flammability index GWFI according to EN 60695-2-12	850
Glow wire ignition temperature GWIT according to EN 60695-2-13	775
Temperature for the ball pressure test according to EN 60695-10-2	125 °C

Dimensions

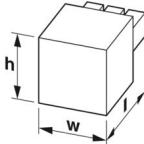
Dimensional drawing	
Pitch	5 mm
Width [w]	61.4 mm
Height [h]	19.6 mm
Length [l]	36.9 mm

Notes

QC 1,5/12-ST - PCB connector



1718067

<https://www.phoenixcontact.com/us/products/1718067>

Notes on operation	In accordance with IEC 61984, COMBICON connectors have no switching power (COC). During designated use, they must not be plugged in or disconnected when carrying voltage or under load.
--------------------	--

Environmental and real-life conditions

Ambient conditions

Ambient temperature (storage/transport)	-40 °C ... 70 °C
Relative humidity (storage/transport)	30 % ... 70 %
Ambient temperature (assembly)	-5 °C ... 100 °C
Ambient temperature (operation)	-40 °C ... 100 °C (dependent on the derating curve)

Electrical tests

Air clearances and creepage distances |

Specification	IEC 60664-1:2007-04
Insulating material group	I
Comparative tracking index (IEC 60112)	CTI 600
Rated insulation voltage (III/3)	500 V
Rated surge voltage (III/3)	6 kV
minimum clearance value - non-homogenous field (III/3)	5.5 mm
minimum creepage distance (III/3)	6.3 mm
Rated insulation voltage (III/2)	630 V
Rated surge voltage (III/2)	6 kV
minimum clearance value - non-homogenous field (III/2)	5.5 mm
minimum creepage distance (III/2)	5.5 mm
Rated insulation voltage (II/2)	1000 V
Rated surge voltage (II/2)	6 kV
minimum clearance value - non-homogenous field (II/2)	5.5 mm
minimum creepage distance (II/2)	5.5 mm

Packaging specifications

Type of packaging	packed in cardboard
-------------------	---------------------

QC 1,5/12-ST - PCB connector



1718067

<https://www.phoenixcontact.com/us/products/1718067>

Approvals

To download certificates, visit the product detail page: <https://www.phoenixcontact.com/us/products/1718067>

 cULus Recognized Approval ID: E60425-19931011				
	Nominal voltage U_N	Nominal current I_N	Cross section AWG	Cross section mm^2
B	300 V	10 A	24 - 16	-
D	300 V	10 A	24 - 16	-

QC 1,5/12-ST - PCB connector



1718067

<https://www.phoenixcontact.com/us/products/1718067>

Classifications

ECLASS

ECLASS-13.0	27460202
ECLASS-15.0	27460202

ETIM

ETIM 10.0	EC002638
-----------	----------

UNSPSC

UNSPSC 21.0	39121400
-------------	----------

QC 1,5/12-ST - PCB connector



1718067

<https://www.phoenixcontact.com/us/products/1718067>

Environmental product compliance

EU RoHS

Fulfills EU RoHS substance requirements	Yes, No exemptions
---	--------------------

China RoHS

Environment friendly use period (EFUP)	EFUP-E
	No hazardous substances above the limits

EU REACH SVHC

REACH candidate substance (CAS No.)	No substance above 0.1 wt%
-------------------------------------	----------------------------

EF3.1 Climate Change

CO2e kg	0.439 kg CO2e
---------	---------------

Phoenix Contact 2026 © - all rights reserved
<https://www.phoenixcontact.com>

Phoenix Contact USA
586 Fulling Mill Road
Middletown, PA 17057, United States
(+717) 944-1300
info@phoenixcon.com