

TVFKC 1,5/ 3-ST CP1,2BDL-N - PCB connector



1710980

<https://www.phoenixcontact.com/us/products/1710980>

Please be informed that the data shown in this PDF document is generated from our online catalog. Please find the complete data in the user documentation. Our general terms of use for downloads are valid.



The figure shows a 10-position version of the product

PCB TWIN plug, nominal cross section: 1.5 mm², color: green, nominal current: 10 A, rated voltage (III/2): 320 V, contact surface: Sn, contact connection type: Socket, number of potentials: 3, number of rows: 1, number of positions: 3, number of connections: 6, product range: TVFKC 1,5/..-ST, pitch: 5 mm, connection method: Push-in spring connection, conductor/PCB connection direction: 0 °, locking clip: - Locking clip, plug-in system: COMBICON MSTB 2,5, locking: without, mounting method: without, type of packaging: packed in cardboard

Your advantages

- Time saving push-in connection, tools not required
- Potentials can be easily looped through – ideal for BUS applications
- Intuitive operation due to color-coded actuating push button
- Can be combined with the MSTB 2,5 range
- Quick and convenient testing using integrated test option

Commercial data

| | |
|--------------------------------------|---------------|
| Item number | 1710980 |
| Packing unit | 50 pc |
| Minimum order quantity | 50 pc |
| Product key | AACFNA |
| GTIN | 4055626196961 |
| Weight per piece (including packing) | 4.71 g |
| Weight per piece (excluding packing) | 4.404 g |
| Country of origin | GR |

TVFKC 1,5/ 3-ST CP1,2BDL-N - PCB connector



1710980

<https://www.phoenixcontact.com/us/products/1710980>

Technical data

Product properties

| | |
|-----------------------|-----------------------|
| Product type | PCB TWIN plug |
| Product family | TVFKC 1,5/...-ST |
| Product line | COMBICON Connectors M |
| Number of positions | 3 |
| Pitch | 5 mm |
| Number of connections | 6 |
| Number of rows | 1 |
| Number of potentials | 3 |

Electrical properties

Properties

| | |
|-----------------------------|--------|
| Nominal current I_N | 10 A |
| Nominal voltage U_N | 320 V |
| Contact resistance | 1.3 mΩ |
| Rated voltage (III/3) | 250 V |
| Rated surge voltage (III/3) | 4 kV |
| Rated voltage (III/2) | 320 V |
| Rated surge voltage (III/2) | 4 kV |
| Rated voltage (II/2) | 630 V |
| Rated surge voltage (II/2) | 4 kV |

Connection data

Connection technology

| | |
|-------------------------|---------------------|
| Type | Standard |
| Connector system | COMBICON MSTB 2,5 |
| Nominal cross section | 1.5 mm ² |
| Contact connection type | Socket |

Interlock

| | |
|---------------|---------|
| Locking type | without |
| Mounting type | without |

Conductor connection

| | |
|---|--|
| Connection method | Push-in spring connection |
| Conductor/PCB connection direction | 0 ° |
| Conductor cross-section rigid | 0.2 mm ² ... 1.5 mm ² |
| Conductor cross-section flexible | 0.2 mm ² ... 1.5 mm ² |
| Conductor cross-section AWG | 24 ... 16 |
| Conductor cross-section, flexible, with ferrule, without plastic sleeve | 0.25 mm ² ... 1.5 mm ² (only together with CRIMPFOX 6) |
| Conductor cross-section, flexible, with ferrule, with plastic sleeve | 0.25 mm ² ... 1.5 mm ² (only together with CRIMPFOX 6) |

TVFKC 1,5/ 3-ST CP1,2BDL-N - PCB connector



1710980

<https://www.phoenixcontact.com/us/products/1710980>

| | |
|------------------------------------|--------------------------|
| Cylindrical gauge a x b / diameter | 2.4 mm x 1.5 mm / 1.9 mm |
| Stripping length | 8 mm |

Specifications for ferrules without insulating collar

| | |
|---------------------------|--------------------|
| recommended crimping tool | 1212034 CRIMPFOX 6 |
|---------------------------|--------------------|

Specifications for ferrules with insulating collar

| | |
|---------------------------|--------------------|
| recommended crimping tool | 1212034 CRIMPFOX 6 |
|---------------------------|--------------------|

Material specifications

Material data - contact

| | |
|--|--|
| Note | WEEE/RoHS-compliant, free of whiskers according to IEC 60068-2-82/JEDEC JESD 201 |
| Contact material | Cu alloy |
| Surface characteristics | hot-dip tin-plated |
| Metal surface terminal point (top layer) | Tin (4 µm - 8 µm Sn) |
| Metal surface contact area (top layer) | Tin (4 µm - 8 µm Sn) |

Material data - housing

| | |
|---|--------------|
| Color (Housing) | green (6021) |
| Insulating material | PA |
| Insulating material group | I |
| CTI according to IEC 60112 | 600 |
| Flammability rating according to UL 94 | V0 |
| Glow wire flammability index GWFI according to EN 60695-2-12 | 850 |
| Glow wire ignition temperature GWIT according to EN 60695-2-13 | 775 |
| Temperature for the ball pressure test according to EN 60695-10-2 | 125 °C |

Material data – actuating element

| | |
|--|---------------|
| Color (Actuating element) | orange (2003) |
| Insulating material | PA |
| Insulating material group | I |
| CTI according to IEC 60112 | 600 |
| Flammability rating according to UL 94 | V0 |

Dimensions

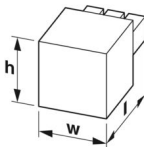
| | |
|---------------------|--|
| Dimensional drawing |  |
| Pitch | 5 mm |
| Width [w] | 15 mm |
| Height [h] | 15 mm |

TVFKC 1,5/ 3-ST CP1,2BDL-N - PCB connector



1710980

<https://www.phoenixcontact.com/us/products/1710980>

| | |
|------------|---------|
| Length [l] | 23.3 mm |
|------------|---------|

Notes

| | |
|--------------------|--|
| Notes on operation | In accordance with IEC 61984, COMBICON connectors have no switching power (COC). During designated use, they must not be plugged in or disconnected when carrying voltage or under load. |
|--------------------|--|

Mechanical tests

Conductor connection

| | |
|---------------|---------------------|
| Specification | IEC 60999-1:1999-11 |
| Result | Test passed |

Test for conductor damage and slackening

| | |
|---------------|---------------------|
| Specification | IEC 60999-1:1999-11 |
| Result | Test passed |

Repeated connection and disconnection

| | |
|---------------|---------------------|
| Specification | IEC 60999-1:1999-11 |
| Result | Test passed |

Pull-out test

| | |
|---|---|
| Specification | IEC 60999-1:1999-11 |
| Conductor cross-section/conductor type/tractive force setpoint/actual value | 0.2 mm ² / solid / > 10 N |
| | 0.2 mm ² / flexible / > 10 N |
| | 1.5 mm ² / solid / > 40 N |
| | 1.5 mm ² / flexible / > 40 N |

Insertion and withdrawal forces

| | |
|-------------------------------------|------------------------|
| Specification | IEC 60512-13-2:2006-02 |
| Result | Test passed |
| No. of cycles | 25 |
| Insertion strength per pos. approx. | 8 N |
| Withdraw strength per pos. approx. | 6 N |

Resistance of inscriptions

| | |
|---------------|------------------------|
| Specification | IEC 60068-2-70:1995-12 |
| Result | Test passed |

Polarization and coding

| | |
|---------------|------------------------|
| Specification | IEC 60512-13-5:2006-02 |
| Result | Test passed |

Visual inspection

| | |
|---------------|-----------------------|
| Specification | IEC 60512-1-1:2002-02 |
| Result | Test passed |

Dimension check

| | |
|---------------|-----------------------|
| Specification | IEC 60512-1-2:2002-02 |
|---------------|-----------------------|

TVFKC 1,5/ 3-ST CP1,2BDL-N - PCB connector



1710980

<https://www.phoenixcontact.com/us/products/1710980>

| | |
|--------|-------------|
| Result | Test passed |
|--------|-------------|

Environmental and real-life conditions

Durability test

| | |
|--|-----------------------|
| Specification | IEC 60512-9-1:2010-03 |
| Impulse withstand voltage at sea level | 4.8 kV |
| Contact resistance R ₁ | 1.3 mΩ |
| Contact resistance R ₂ | 1.4 mΩ |
| Insertion/withdrawal cycles | 25 |
| Insulation resistance, neighboring positions | > 5 MΩ |

Climatic test

| | |
|-----------------------------------|---|
| Specification | ISO 6988:1985-02 |
| Corrosive stress | 0.2 dm ³ SO ₂ on 300 dm ³ /40 °C/1 cycle |
| Thermal stress | 105 °C/168 h |
| Power-frequency withstand voltage | 2.21 kV |

Vibration test

| | |
|------------------------|-----------------------------|
| Specification | IEC 60068-2-6:2007-12 |
| Frequency | 10 - 150 - 10 Hz |
| Sweep speed | 1 octave/min |
| Amplitude | 0.35 mm (10 Hz ... 60.1 Hz) |
| Acceleration | 5g (60.1 Hz ... 150 Hz) |
| Test duration per axis | 2.5 h |
| Test directions | X-, Y- and Z-axis |

Ambient conditions

| | |
|---|---|
| Ambient temperature (storage/transport) | -40 °C ... 70 °C |
| Relative humidity (storage/transport) | 30 % ... 70 % |
| Ambient temperature (assembly) | -5 °C ... 100 °C |
| Ambient temperature (operation) | -40 °C ... 105 °C (dependent on the derating curve) |

Ambient conditions

| | |
|---|---|
| Ambient temperature (operation) | -40 °C ... 105 °C (dependent on the derating curve) |
| Ambient temperature (storage/transport) | -40 °C ... 70 °C |
| Relative humidity (storage/transport) | 30 % ... 70 % |
| Ambient temperature (assembly) | -5 °C ... 100 °C |

Electrical tests

Thermal test | Test group C

| | |
|----------------------------|-----------------------|
| Specification | IEC 60512-5-1:2002-02 |
| Tested number of positions | 10 |

Insulation resistance

| | |
|---------------|-----------------------|
| Specification | IEC 60512-3-1:2002-02 |
|---------------|-----------------------|

TVFKC 1,5/ 3-ST CP1,2BDL-N - PCB connector



1710980

<https://www.phoenixcontact.com/us/products/1710980>

| | |
|--|--------|
| Insulation resistance, neighboring positions | > 5 MΩ |
|--|--------|

Air clearances and creepage distances |

| | |
|--|---------------------|
| Specification | IEC 60664-1:2007-04 |
| Insulating material group | I |
| Comparative tracking index (IEC 60112) | CTI 600 |
| Rated insulation voltage (III/3) | 250 V |
| Rated surge voltage (III/3) | 4 kV |
| minimum clearance value - non-homogenous field (III/3) | 3 mm |
| minimum creepage distance (III/3) | 3.2 mm |
| Rated insulation voltage (III/2) | 320 V |
| Rated surge voltage (III/2) | 4 kV |
| minimum clearance value - non-homogenous field (III/2) | 3 mm |
| minimum creepage distance (III/2) | 3 mm |
| Rated insulation voltage (II/2) | 630 V |
| Rated surge voltage (II/2) | 4 kV |
| minimum clearance value - non-homogenous field (II/2) | 3 mm |
| minimum creepage distance (II/2) | 3.2 mm |

Packaging specifications

| | |
|-------------------|---------------------|
| Type of packaging | packed in cardboard |
|-------------------|---------------------|

Drawings

Diagram



Type: TVFKC 1,5/...-ST with MSTB 2,5/...-G

Diagram



Type: TVFKC 1,5/...-ST with MSTBO 2,5/...-G1(L/R)

Diagram



Type: TVFKC 1,5/...-ST with MSTBA 2,5/...-G

Diagram



Type: TVFKC 1,5/...-ST with MSTBV 2,5/...-G

TVFKC 1,5/ 3-ST CP1,2BDL-N - PCB connector



1710980

<https://www.phoenixcontact.com/us/products/1710980>

Diagram



Type: TVFKC 1,5/...-ST with MSTBVA 2,5/...-G

TVFKC 1,5/ 3-ST CP1,2BDL-N - PCB connector



1710980

<https://www.phoenixcontact.com/us/products/1710980>

Approvals

To download certificates, visit the product detail page: <https://www.phoenixcontact.com/us/products/1710980>

|  cULus Recognized Approval ID: E60425-19931011 | | Nominal voltage U_N | Nominal current I_N | Cross section AWG | Cross section mm^2 |
|---|--|-----------------------|-----------------------|-------------------|-----------------------------|
| B | | | | | |
| Only rigid conductors | | 300 V | 10 A | 24 - 16 | - |
| Standard | | 300 V | 8 A | 24 - 16 | - |
| D | | | | | |
| Only rigid conductors | | 300 V | 10 A | 24 - 16 | - |
| Alternative 1 | | 300 V | 8 A | 24 - 16 | - |

TVFKC 1,5/ 3-ST CP1,2BDL-N - PCB connector



1710980

<https://www.phoenixcontact.com/us/products/1710980>

Classifications

ECLASS

| | |
|-------------|----------|
| ECLASS-13.0 | 27460202 |
| ECLASS-15.0 | 27460202 |

ETIM

| | |
|-----------|----------|
| ETIM 10.0 | EC002638 |
|-----------|----------|

UNSPSC

| | |
|-------------|----------|
| UNSPSC 21.0 | 39121400 |
|-------------|----------|

TVFKC 1,5/ 3-ST CP1,2BDL-N - PCB connector



1710980

<https://www.phoenixcontact.com/us/products/1710980>

Environmental product compliance

EU RoHS

| | |
|---|--------------------|
| Fulfills EU RoHS substance requirements | Yes, No exemptions |
|---|--------------------|

China RoHS

| | |
|--|--|
| Environment friendly use period (EFUP) | EFUP-E |
| | No hazardous substances above the limits |

EU REACH SVHC

| | |
|-------------------------------------|----------------------------|
| REACH candidate substance (CAS No.) | No substance above 0.1 wt% |
|-------------------------------------|----------------------------|

EF3.1 Climate Change

| | |
|---------|---------------|
| CO2e kg | 0.073 kg CO2e |
|---------|---------------|

Phoenix Contact 2026 © - all rights reserved
<https://www.phoenixcontact.com>

Phoenix Contact USA
586 Fulling Mill Road
Middletown, PA 17057, United States
(+717) 944-1300
info@phoenixcon.com