

# MKDSD 1,5/ 8-3,81 - PCB terminal block

1705605

<https://www.phoenixcontact.com/us/products/1705605>

Please be informed that the data shown in this PDF document is generated from our online catalog. Please find the complete data in the user documentation. Our general terms of use for downloads are valid.



PCB terminal block, nominal current: 8 A, rated voltage (III/2): 320 V, nominal cross section: 1.5 mm<sup>2</sup>, number of potentials: 8, number of rows: 1, number of positions per row: 8, product range: MKDSD 1,5, pitch: 3.81 mm, connection method: Screw connection with tension sleeve, screw head form: L Slotted, mounting: Wave soldering, conductor/PCB connection direction: 0 °, color: green, Pin layout: Linear pinning, Solder pin [P]: 2.7 mm, number of solder pins per potential: 2, type of packaging: packed in cardboard

## Your advantages

- Well-known connection principle allows worldwide use
- Low temperature rise, thanks to maximum contact force
- Allows connection of two conductors
- Two solder pins reduce the mechanical strain on the soldering spots
- The latching on the side enables various numbers of positions to be combined

## Commercial data

Item number	1705605
Packing unit	50 pc
Minimum order quantity	50 pc
Sales key	AA12
Product key	AALFGL
GTIN	4017918144531
Weight per piece (including packing)	6.376 g
Weight per piece (excluding packing)	6.212 g
Customs tariff number	85369010
Country of origin	BG

# MKDSD 1,5/ 8-3,81 - PCB terminal block



1705605

<https://www.phoenixcontact.com/us/products/1705605>

## Technical data

### Product properties

Product type	PCB terminal block
Product family	MKDSD 1,5
Product line	COMBICON Terminals S
Type	PC termination block
Number of positions	8
Pitch	3.81 mm
Number of connections	8
Number of rows	1
Number of potentials	8
Pin layout	Linear pinning
Solder pins per potential	2

### Electrical properties

#### Properties

Nominal current $I_N$	8 A
Nominal voltage $U_N$	320 V
Rated voltage (III/3)	200 V
Rated surge voltage (III/3)	4 kV
Rated voltage (III/2)	320 V
Rated surge voltage (III/2)	4 kV
Rated voltage (II/2)	500 V
Rated surge voltage (II/2)	4 kV

### Connection data

#### Connection technology

Type	PC termination block
Nominal cross section	1.5 mm <sup>2</sup>

#### Conductor connection

Connection method	Screw connection with tension sleeve
Conductor cross-section rigid	0.14 mm <sup>2</sup> ... 1.5 mm <sup>2</sup>
Conductor cross-section flexible	0.14 mm <sup>2</sup> ... 1.5 mm <sup>2</sup>
Conductor cross-section AWG	26 ... 16
Conductor cross-section, flexible, with ferrule, without plastic sleeve	0.25 mm <sup>2</sup> ... 1.5 mm <sup>2</sup>
Conductor cross-section, flexible, with ferrule, with plastic sleeve	0.25 mm <sup>2</sup> ... 0.5 mm <sup>2</sup>
2 conductors with same cross section, rigid	0.14 mm <sup>2</sup> ... 0.5 mm <sup>2</sup>
2 conductors with same cross section, flexible	0.14 mm <sup>2</sup> ... 0.5 mm <sup>2</sup>
2 conductors with same cross section, flexible, with ferrule without plastic sleeve	0.25 mm <sup>2</sup> ... 0.34 mm <sup>2</sup>

# MKDSD 1,5/ 8-3,81 - PCB terminal block

1705605

<https://www.phoenixcontact.com/us/products/1705605>

2 conductors with the same cross section, flexible, with TWIN ferrule with plastic sleeve	0.5 mm <sup>2</sup> ... 0.5 mm <sup>2</sup>
Stripping length	7 mm
Drive form screw head	Slotted (L)
Tightening torque	0.22 Nm ... 0.25 Nm

## Mounting

Mounting type	Wave soldering
Pin layout	Linear pinning

## Material specifications

### Material data - contact

Note	WEEE/RoHS-compliant, free of whiskers according to IEC 60068-2-82/JEDEC JESD 201
Contact material	Cu alloy
Surface characteristics	hot-dip tin-plated
Metal surface terminal point (top layer)	Tin (5 µm - 7 µm Sn)
Metal surface soldering area (top layer)	Tin (5 µm - 7 µm Sn)

### Material data - housing

Color (Housing)	green (6021)
Insulating material	PA
Insulating material group	I
CTI according to IEC 60112	600
Flammability rating according to UL 94	V0
Glow wire flammability index GWFI according to EN 60695-2-12	850
Glow wire ignition temperature GWIT according to EN 60695-2-13	775
Temperature for the ball pressure test according to EN 60695-10-2	125 °C

## Dimensions

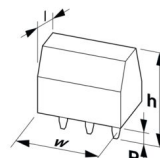
Dimensional drawing	
Pitch	3.81 mm
Width [w]	31.57 mm
Height [h]	15.3 mm
Length [l]	9.3 mm
Installed height	12.6 mm
Solder pin length [P]	2.7 mm
Pin dimensions	0.5 x 0.8 mm

# MKDSD 1,5/ 8-3,81 - PCB terminal block



1705605

<https://www.phoenixcontact.com/us/products/1705605>

## PCB design

Hole diameter	1.1 mm
---------------	--------

## Electrical tests

### Air clearances and creepage distances |

Specification	IEC 60664-1:2007-04
Insulating material group	I
Comparative tracking index (IEC 60112)	CTI 600
Rated insulation voltage (III/3)	200 V
Rated surge voltage (III/3)	4 kV
minimum clearance value - non-homogenous field (III/3)	1.5 mm
minimum creepage distance (III/3)	2.5 mm
Rated insulation voltage (III/2)	320 V
Rated surge voltage (III/2)	4 kV
minimum clearance value - non-homogenous field (III/2)	1.5 mm
minimum creepage distance (III/2)	1.5 mm
Rated insulation voltage (II/2)	500 V
Rated surge voltage (II/2)	4 kV
minimum clearance value - non-homogenous field (II/2)	1.5 mm
minimum creepage distance (II/2)	2 mm

## Environmental and real-life conditions

### Ambient conditions

Ambient temperature (storage/transport)	-40 °C ... 70 °C
Relative humidity (storage/transport)	30 % ... 70 %
Ambient temperature (assembly)	-5 °C ... 100 °C
Ambient temperature (operation)	-40 °C ... 100 °C (Depending on the current carrying capacity/derating curve)

## Packaging specifications

Type of packaging	packed in cardboard
-------------------	---------------------

# MKDSD 1,5/ 8-3,81 - PCB terminal block

1705605

<https://www.phoenixcontact.com/us/products/1705605>

## Drawings

Dimensional drawing



Drilling plan/solder pad geometry



# MKDSD 1,5/ 8-3,81 - PCB terminal block





1705605

<https://www.phoenixcontact.com/us/products/1705605>

## Approvals

To download certificates, visit the product detail page: <https://www.phoenixcontact.com/us/products/1705605>

 <b>cULus Recognized</b> Approval ID: E60425-19770427				
	Nominal voltage $U_N$	Nominal current $I_N$	Cross section AWG	Cross section $\text{mm}^2$
B	300 V	10 A	30 - 14	-
D	300 V	10 A	30 - 14	-

 <b>VDE approval of drawings</b> Approval ID: 40055535				
	Nominal voltage $U_N$	Nominal current $I_N$	Cross section AWG	Cross section $\text{mm}^2$
keine	320 V	12 A	-	0.2 - 1.5

# MKDSD 1,5/ 8-3,81 - PCB terminal block



1705605

<https://www.phoenixcontact.com/us/products/1705605>

## Classifications

### ECLASS

ECLASS-13.0	27460101
ECLASS-15.0	27460101

### ETIM

ETIM 10.0	EC002643
-----------	----------

### UNSPSC

UNSPSC 21.0	39121400
-------------	----------

# MKDSD 1,5/ 8-3,81 - PCB terminal block



1705605

<https://www.phoenixcontact.com/us/products/1705605>

## Environmental product compliance

### EU RoHS

Fulfills EU RoHS substance requirements	Yes, No exemptions
---	--------------------

### China RoHS

Environment friendly use period (EFUP)	EFUP-E
	No hazardous substances above the limits

### EU REACH SVHC

REACH candidate substance (CAS No.)	No substance above 0.1 wt%
-------------------------------------	----------------------------

### EF3.1 Climate Change

CO2e kg	0.153 kg CO2e
---------	---------------

Phoenix Contact 2026 © - all rights reserved  
<https://www.phoenixcontact.com>

Phoenix Contact USA  
586 Fulling Mill Road  
Middletown, PA 17057, United States  
(+717) 944-1300  
[info@phoenixcon.com](mailto:info@phoenixcon.com)