

PC 16/ 3-ST-10,16 BD:L1-L3 - PCB connector



1704741

<https://www.phoenixcontact.com/us/products/1704741>

Please be informed that the data shown in this PDF document is generated from our online catalog. Please find the complete data in the user documentation. Our general terms of use for downloads are valid.

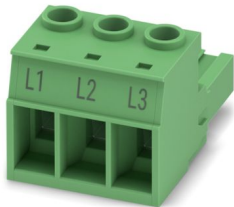

PCB connector, nominal cross section: 16 mm², color: green, nominal current: 76 A, rated voltage (III/2): 1000 V, contact surface: Ag, contact connection type: Socket, number of potentials: 3, number of rows: 1, number of positions: 3, number of connections: 3, product range: PC 16/...-ST, pitch: 10.16 mm, connection method: Screw connection with tension sleeve, screw head form: L Slotted, conductor/PCB connection direction: 0 °, locking clip: - without locking clip, plug-in system: COMBICON PC 16, locking: without, mounting method: without, type of packaging: packed in cardboard

Your advantages

- Well-known connection principle allows worldwide use
- Low temperature rise, thanks to maximum contact force
- Allows connection of two conductors
- Integrated double steel spring provides additional safety in the event of temperature and power fluctuations
- Integrated protective guide prevents incorrect insertion of the conductor underneath the tension sleeve

Commercial data

Item number	1704741
Packing unit	25 pc
Minimum order quantity	25 pc
Note	Made to order (non-returnable)
Product key	AAEAAA
GTIN	4017918995263
Weight per piece (including packing)	28.33 g
Weight per piece (excluding packing)	27.054 g
Country of origin	PL

PC 16/ 3-ST-10,16 BD:L1-L3 - PCB connector



1704741

<https://www.phoenixcontact.com/us/products/1704741>

Technical data

Product properties

Product type	PCB connector
Product family	PC 16/...-ST
Product line	COMBICON Connectors XL
Number of positions	3
Pitch	10.16 mm
Number of connections	3
Number of rows	1
Number of potentials	3
Mounting type	without

Electrical properties

Properties

Nominal current I_N	76 A
Nominal voltage U_N	1000 V
Contact resistance	0.22 mΩ
Rated voltage (III/3)	1000 V
Rated surge voltage (III/3)	8 kV
Rated voltage (III/2)	1000 V
Rated surge voltage (III/2)	8 kV
Rated voltage (II/2)	1000 V
Rated surge voltage (II/2)	6 kV

Connection data

Connection technology

Type	Standard
Connector system	COMBICON PC 16
Nominal cross section	16 mm ²
Contact connection type	Socket

Interlock

Locking type	without
Mounting type	without

Conductor connection

Connection method	Screw connection with tension sleeve
Conductor/PCB connection direction	0 °
Conductor cross-section rigid	0.75 mm ² ... 16 mm ²
Conductor cross-section flexible	0.75 mm ² ... 16 mm ²
Conductor cross-section AWG	18 ... 6
Conductor cross-section, flexible, with ferrule, without plastic sleeve	0.5 mm ² ... 16 mm ² (Only in connection with CRIMPFOX 16 S)

PC 16/ 3-ST-10,16 BD:L1-L3 - PCB connector



1704741

<https://www.phoenixcontact.com/us/products/1704741>

Conductor cross-section, flexible, with ferrule, with plastic sleeve	0.5 mm ² ... 10 mm ² (Only in connection with CRIMPFOX 16 S)
2 conductors with same cross section, rigid	0.75 mm ² ... 6 mm ²
2 conductors with same cross section, flexible	0.75 mm ² ... 6 mm ²
2 conductors with same cross section, flexible, with ferrule without plastic sleeve	0.5 mm ² ... 4 mm ²
2 conductors with the same cross section, flexible, with TWIN ferrule with plastic sleeve	0.5 mm ² ... 6 mm ²
Cylindrical gauge a x b / diameter	- / 5.4 mm
Stripping length	12 mm
Drive form screw head	Slotted (L)
Tightening torque	1.7 Nm ... 1.8 Nm

Material specifications

Material data - contact

Note	WEEE/RoHS-compliant, free of whiskers according to IEC 60068-2-82/JEDEC JESD 201
Contact material	Cu alloy
Surface characteristics	Selective coating
Metal surface terminal point (top layer)	Tin (4 µm - 8 µm Sn)
Metal surface terminal point (middle layer)	Nickel flash (Ni flash)
Metal surface contact area (top layer)	Silver (2 µm - 4 µm Ag)
Metal surface contact area (middle layer)	Nickel flash (Ni flash)

Material data - housing

Color (Housing)	green (6021)
Insulating material	PA
Insulating material group	I
CTI according to IEC 60112	600
Flammability rating according to UL 94	V0
Glow wire flammability index GWFI according to EN 60695-2-12	850
Glow wire ignition temperature GWIT according to EN 60695-2-13	775
Temperature for the ball pressure test according to EN 60695-10-2	125 °C

Dimensions

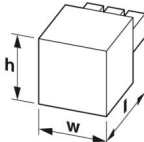
Dimensional drawing	
Pitch	10.16 mm
Width [w]	30.32 mm
Height [h]	27.8 mm
Length [l]	41.5 mm

PC 16/ 3-ST-10,16 BD:L1-L3 - PCB connector



1704741

<https://www.phoenixcontact.com/us/products/1704741>

Notes

Notes on operation	In accordance with IEC 61984, COMBICON connectors have no switching power (COC). During designated use, they must not be plugged in or disconnected when carrying voltage or under load.
--------------------	--

Mechanical tests

Test for conductor damage and slackening

Specification	IEC 60999-1:1999-11
Result	Test passed

Pull-out test

Specification	IEC 60999-1:1999-11
Conductor cross-section/conductor type/tractive force setpoint/actual value	0.75 mm ² / solid / > 30 N
	0.75 mm ² / flexible / > 30 N
	16 mm ² / solid / > 100 N
	16 mm ² / flexible / > 100 N

Insertion and withdrawal forces

Specification	IEC 60512-13-2:2006-02
Result	Test passed
No. of cycles	50
Insertion strength per pos. approx.	17 N
Withdraw strength per pos. approx.	17 N

Torque test

Specification	IEC 60999-1:1999-11
---------------	---------------------

Resistance of inscriptions

Specification	IEC 60068-2-70:1995-12
Result	Test passed

Polarization and coding

Specification	IEC 60512-13-5:2006-02
Result	Test passed

Visual inspection

Specification	IEC 60512-1-1:2002-02
Result	Test passed

Dimension check

Specification	IEC 60512-1-2:2002-02
Result	Test passed

Environmental and real-life conditions

Durability test

Specification	IEC 60512-9-1:2010-03
---------------	-----------------------

PC 16/ 3-ST-10,16 BD:L1-L3 - PCB connector



1704741

<https://www.phoenixcontact.com/us/products/1704741>

Impulse withstand voltage at sea level	9.8 kV
Contact resistance R ₁	0.22 mΩ
Contact resistance R ₂	0.24 mΩ
Insertion/withdrawal cycles	50
Insulation resistance, neighboring positions	> 5 MΩ

Climatic test

Specification	ISO 6988:1985-02
Corrosive stress	0.2 dm ³ SO ₂ on 300 dm ³ /40 °C/1 cycle
Thermal stress	100 °C/168 h
Power-frequency withstand voltage	4.26 kV

Vibration test

Specification	IEC 60068-2-6:2007-12
Frequency	10 - 150 - 10 Hz
Sweep speed	1 octave/min
Amplitude	0.35 mm (10 Hz ... 60.1 Hz)
Acceleration	5g (60.1 Hz ... 150 Hz)
Test duration per axis	2.5 h
Test directions	X-, Y- and Z-axis

Ambient conditions

Ambient temperature (storage/transport)	-40 °C ... 70 °C
Relative humidity (storage/transport)	30 % ... 70 %
Ambient temperature (assembly)	-5 °C ... 100 °C
Ambient temperature (operation)	-40 °C ... 100 °C (dependent on the derating curve)

Electrical tests

Thermal test | Test group C

Specification	IEC 60512-5-1:2002-02
Tested number of positions	9

Insulation resistance

Specification	IEC 60512-3-1:2002-02
Insulation resistance, neighboring positions	> 5 MΩ

Air clearances and creepage distances |

Specification	IEC 60664-1:2007-04
Insulating material group	I
Comparative tracking index (IEC 60112)	CTI 600
Rated insulation voltage (III/3)	1000 V
Rated surge voltage (III/3)	8 kV
minimum clearance value - non-homogenous field (III/3)	8 mm
minimum creepage distance (III/3)	12.5 mm
Rated insulation voltage (III/2)	1000 V
Rated surge voltage (III/2)	8 kV

PC 16/ 3-ST-10,16 BD:L1-L3 - PCB connector



1704741

<https://www.phoenixcontact.com/us/products/1704741>

minimum clearance value - non-homogenous field (III/2)	8 mm
minimum creepage distance (III/2)	8 mm
Rated insulation voltage (II/2)	1000 V
Rated surge voltage (II/2)	6 kV
minimum clearance value - non-homogenous field (II/2)	5.5 mm
minimum creepage distance (II/2)	5.5 mm

Packaging specifications

Type of packaging	packed in cardboard
-------------------	---------------------

Drawings

Diagram

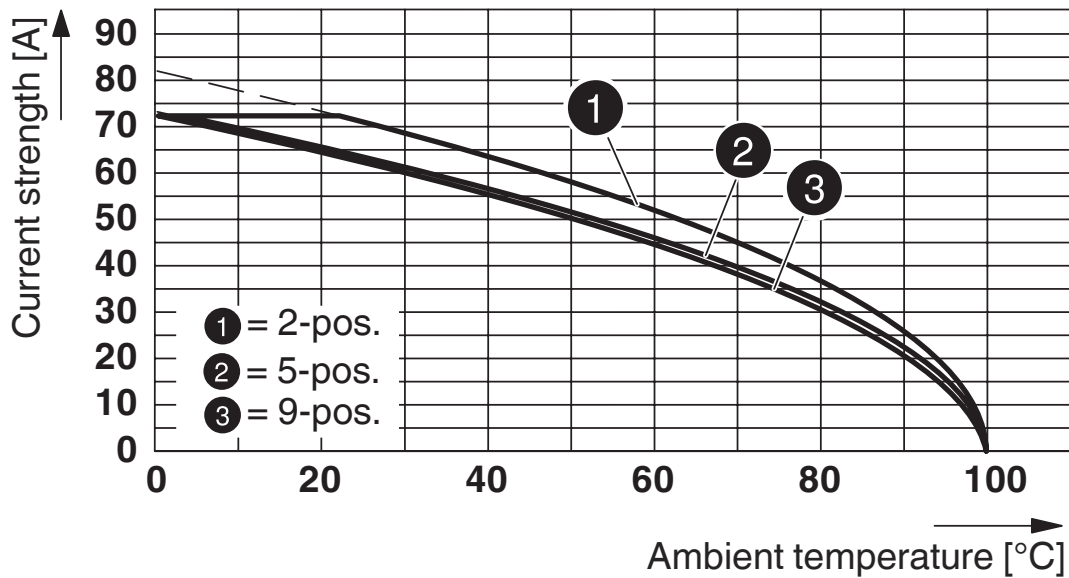

Type: PC 16/...-ST-10,16 with PC 6-16/...-G1-10,16

Diagram

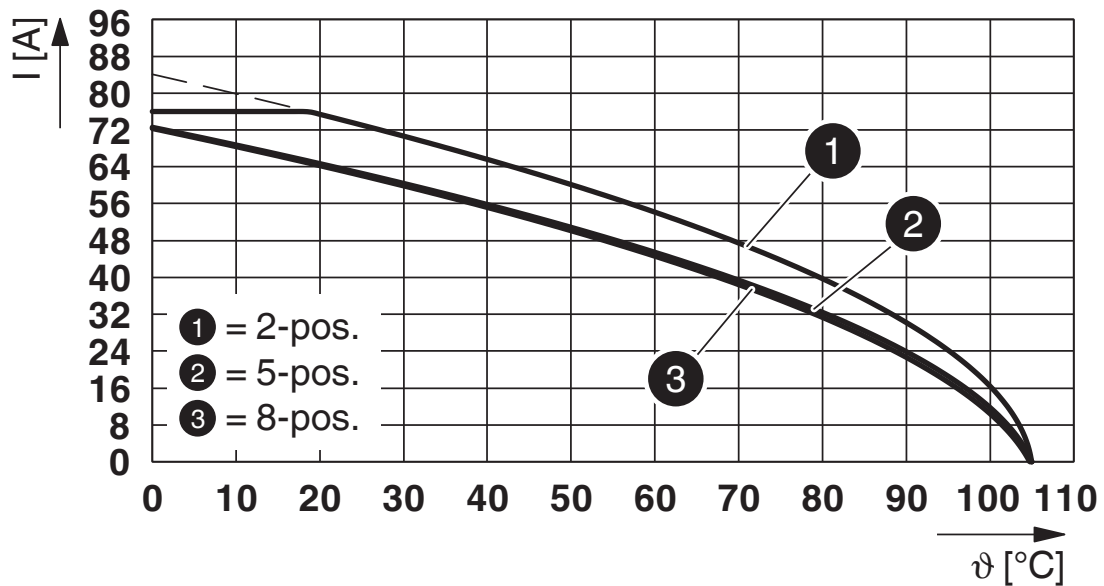

Type: PC 16/...-ST-10,16 with PC 6-16/...-G-10,16

1704741

<https://www.phoenixcontact.com/us/products/1704741>

Diagram



Type: PC 16/...-ST-10,16 with PCV 6-16/...-G-10,16

Diagram

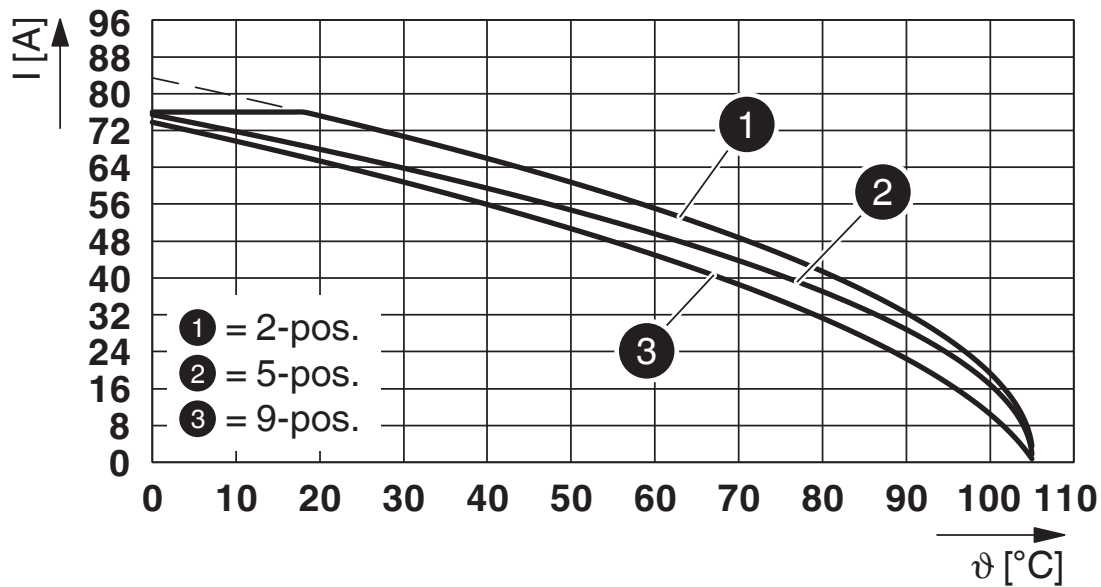

Type: PC 16/...-ST-10,16 with PCV 6-16/...-G1-10,16

1704741

<https://www.phoenixcontact.com/us/products/1704741>



Type: PC 16/...-ST-10,16 with industrial PC 16/...-ST-10,16

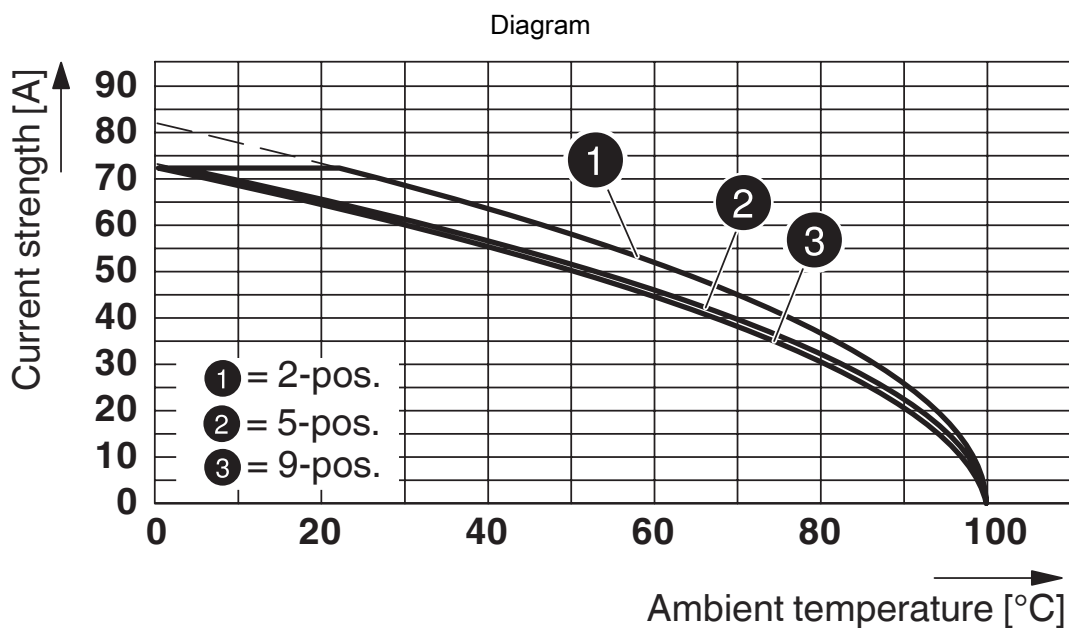

Type: PC 16/...-ST-10,16 with PC 6-16/...-G1-10,16 HT BK R...

1704741

<https://www.phoenixcontact.com/us/products/1704741>



Type: PC 16/...-ST-10,16 with DFK-PC 6-16/...-G-10,16

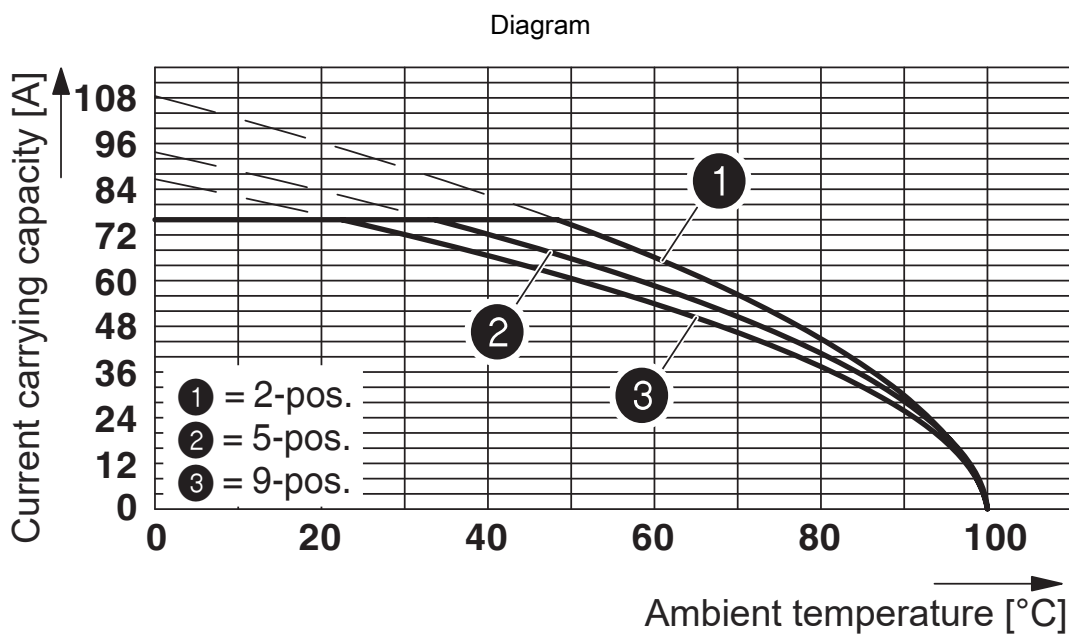

Derating curve for: PC 16/...-ST-10.16 with DFK-PC 16/...-ST-10.16

PC 16/ 3-ST-10,16 BD:L1-L3 - PCB connector



1704741

<https://www.phoenixcontact.com/us/products/1704741>

Diagram



Type: PC 16/...-ST-10,16 with ISPC 16/...-ST-10,16

PC 16/ 3-ST-10,16 BD:L1-L3 - PCB connector



1704741

<https://www.phoenixcontact.com/us/products/1704741>

Approvals

To download certificates, visit the product detail page: <https://www.phoenixcontact.com/us/products/1704741>

 cULus Recognized Approval ID: E60425-20040202				
	Nominal voltage U_N	Nominal current I_N	Cross section AWG	Cross section mm^2
B	600 V	55 A	20 - 6	-
C	600 V	55 A	20 - 6	-

 VDE approval of drawings Approval ID: 40055586				
	Nominal voltage U_N	Nominal current I_N	Cross section AWG	Cross section mm^2
keine	1000 V	76 A	-	0.75 - 16

PC 16/ 3-ST-10,16 BD:L1-L3 - PCB connector



1704741

<https://www.phoenixcontact.com/us/products/1704741>

Classifications

ECLASS

ECLASS-13.0	27460202
ECLASS-15.0	27460202

ETIM

ETIM 10.0	EC002638
-----------	----------

UNSPSC

UNSPSC 21.0	39121400
-------------	----------

PC 16/ 3-ST-10,16 BD:L1-L3 - PCB connector



1704741

<https://www.phoenixcontact.com/us/products/1704741>

Environmental product compliance

EU RoHS

Fulfills EU RoHS substance requirements	Yes, No exemptions
---	--------------------

China RoHS

Environment friendly use period (EFUP)	EFUP-E
	No hazardous substances above the limits

EU REACH SVHC

REACH candidate substance (CAS No.)	No substance above 0.1 wt%
-------------------------------------	----------------------------

Phoenix Contact 2026 © - all rights reserved
<https://www.phoenixcontact.com>

Phoenix Contact USA
586 Fulling Mill Road
Middletown, PA 17057, United States
(+717) 944-1300
info@phoenixcon.com