

HC-B 24-TMB-SD-IP65 - Protective cover



1690969

<https://www.phoenixcontact.com/us/products/1690969>

Please be informed that the data shown in this PDF document is generated from our online catalog. Please find the complete data in the user documentation. Our general terms of use for downloads are valid.



HEAVYCON ADVANCE IP65 protective cover B24, with bayonet locking, with retaining cord, diameter of retaining cord eyelet 3 mm

Commercial data

Item number	1690969
Packing unit	1 pc
Note	Made to order (non-returnable)
Sales key	BF66
Product key	AF7AZC
GTIN	4017918980375
Weight per piece (including packing)	86.9 g
Weight per piece (excluding packing)	82.19 g
Customs tariff number	85389099
Country of origin	DE

HC-B 24-TMB-SD-IP65 - Protective cover

1690969

<https://www.phoenixcontact.com/us/products/1690969>

Technical data

Product properties

Product type	Protective cover
Housing type	Protective cover
Type	B24
Seal present	yes

Dimensions

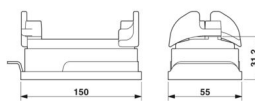
Dimensional drawing	
Width	55 mm
Height	31.2 mm
Length	150 mm
Diameter	3.5 mm

Material specifications

Material Protective cover	PA
Flammability rating according to UL 94	V0
Seal material	NBR
Material, protective cover	PA
Locking latch material	High-grade steel, handle: PA-GF

Mechanical properties

Mechanical data

Locking type	Screw
--------------	-------

Environmental and real-life conditions

Ambient conditions

Degree of protection	IP65
Ambient temperature (operation)	-20 °C ... 100 °C

HC-B 24-TMB-SD-IP65 - Protective cover



1690969

<https://www.phoenixcontact.com/us/products/1690969>

Drawings

Dimensional drawing

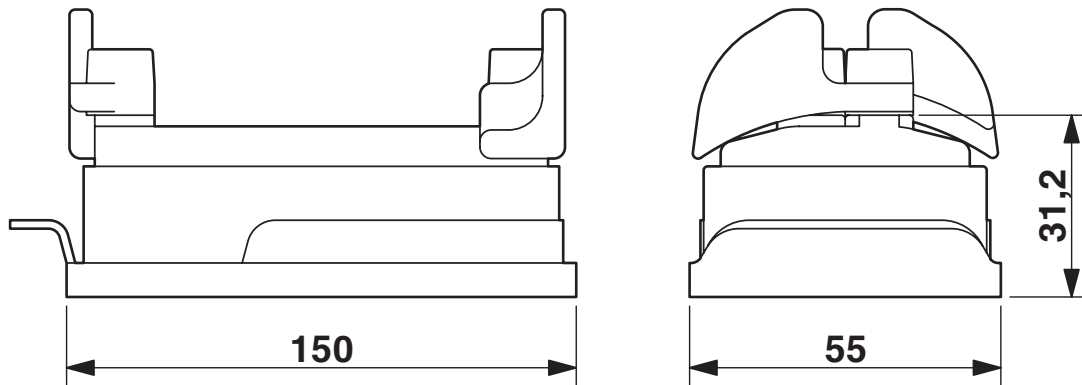

Dimensional drawing

HC-B 24-TMB-SD-IP65 - Protective cover



1690969

<https://www.phoenixcontact.com/us/products/1690969>

Classifications

ECLASS

ECLASS-13.0	27440208
ECLASS-15.0	27440208

UNSPSC

UNSPSC 21.0	39121400
-------------	----------

HC-B 24-TMB-SD-IP65 - Protective cover



1690969

<https://www.phoenixcontact.com/us/products/1690969>

Environmental product compliance

EU RoHS

Fulfills EU RoHS substance requirements	Yes, No exemptions
---	--------------------

China RoHS

Environment friendly use period (EFUP)	EFUP-E
	No hazardous substances above the limits

EU REACH SVHC

REACH candidate substance (CAS No.)	No substance above 0.1 wt%
-------------------------------------	----------------------------

Phoenix Contact 2026 © - all rights reserved
<https://www.phoenixcontact.com>

Phoenix Contact USA
586 Fulling Mill Road
Middletown, PA 17057, United States
(+717) 944-1300
info@phoenixcon.com