

# SAC-3P-M12Y/2X1,5-PUR/M12FS - Sensor/actuator cable



1682553

<https://www.phoenixcontact.com/us/products/1682553>

Please be informed that the data shown in this PDF document is generated from our online catalog. Please find the complete data in the user documentation. Our general terms of use for downloads are valid.



Sensor/actuator cable, 3-position, PUR halogen-free, black-gray RAL 7021, Plug straight M12, coding: A, on Socket straight M12, coding: A and Socket straight M12, coding: A, cable length: 1.5 m

As shown in the illustration but with a yellow conductor

## Commercial data

Item number	1682553
Packing unit	5 pc
Minimum order quantity	5 pc
Note	Made to order (non-returnable)
Sales key	BF03
Product key	AF1COA
GTIN	4017918379384
Weight per piece (including packing)	107 g
Weight per piece (excluding packing)	106.31 g
Customs tariff number	85444290
Country of origin	PL

# SAC-3P-M12Y/2X1,5-PUR/M12FS - Sensor/actuator cable



1682553

<https://www.phoenixcontact.com/us/products/1682553>

## Technical data

### Product properties

Product type	Distributor with cable
Number of positions	3
No. of cable outlets	2
Shielded	no
Coding	A

### Insulation characteristics

Overvoltage category	II
Degree of pollution	3

### Material specifications

Flammability rating according to UL 94	HB
Seal material	NBR
Material of grip body	TPU, hardly inflammable, self-extinguishing
Contact material	CuSn
Contact surface material	Ni/Au
Contact carrier material	TPU GF
Material for screw connection	Zinc die-cast, nickel-plated

### Electrical properties

Insulation resistance	$\geq 10 \text{ G}\Omega$
Nominal voltage $U_N$	48 V AC
	60 V DC
Nominal current $I_N$	4 A

### Mechanical properties

#### Mechanical data

Insertion/withdrawal cycles	$\geq 100$
-----------------------------	------------

### Signaling

Status display	no
Status display present	no

### Connector

#### Connection 1

Type	Plug straight M12
Coding type	A

#### Connection 2

Type	Socket straight M12
Coding type	A

# SAC-3P-M12Y/2X1,5-PUR/M12FS - Sensor/actuator cable

1682553

<https://www.phoenixcontact.com/us/products/1682553>

## Connection 3

Type	Socket straight M12
Coding type	A

## Cable/line

Cable length	1.5 m
--------------	-------

## PUR halogen-free black [PUR]

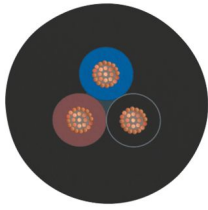
Dimensional drawing	
Cable weight	23 kg/km
UL AWM Style	20549
Number of positions	3
Shielded	no
Cable type	PUR halogen-free black [PUR]
Conductor structure signal line	42x 0.10 mm
AWG signal line	22
Conductor cross-section	3x 0.34 mm <sup>2</sup> (Signal line)
Wire diameter incl. insulation	1.27 mm ±0.02 mm (Signal line)
External cable diameter	3.85 mm ±0.15 mm
Outer sheath, material	PUR
External sheath, color	black-gray RAL 7021
Conductor material	Bare Cu litz wires
Material wire insulation	PP
Single wire, color	brown, blue, black
Thickness, insulation	≥ 0.21 mm (Core insulation) approx. 0.50 mm (Outer cable sheath)
Overall twist	3 wires, twisted
Max. conductor resistance	max. 58 Ω/km (at 20 °C)
Insulation resistance	≥ 100 GΩ*km (at 20 °C)
Nominal voltage, cable	≤ 300 V
Test voltage	≥ 3000 V
Smallest bending radius, fixed installation	19 mm
Smallest bending radius, movable installation	38 mm
Dynamic load capacity (bending)	Max. bending cycles: 10000000, Bending radius: 38 mm, Bending radius: 10 x D, Traversing path: 10 m, Traversing rate: 3 m/s, Acceleration: 10 m/s <sup>2</sup>
Dynamic load capacity (torsion)	Torsion: ±180 °/m, Torsion cycles: ≥5000000, Torsional frequency: 35 cycles/min.

# SAC-3P-M12Y/2X1,5-PUR/M12FS - Sensor/actuator cable



1682553

<https://www.phoenixcontact.com/us/products/1682553>

Halogen-free	in accordance with DIN VDE 0472 part 815
Flame resistance	in accordance with UL 758/1581 FT2
	DIN EN 60332-2-2 (20 s)
Resistance to oil	in accordance with DIN EN 60811-2-1
Other resistance	Highly resistant to acids, alkaline solutions and solvents
	hydrolysis and microbe resistant
	partly UV-resistant (in accordance with DIN EN ISO 4892-2-A)
Special properties	Flexible cable conduit capable
	Silicone-free
	Free of substances which would hinder coating with paint or varnish
Ambient temperature (operation)	-40 °C ... 80 °C (cable, fixed installation)
	-25 °C ... 80 °C (Cable, flexible installation)

## Environmental and real-life conditions

### Ambient conditions

Degree of protection	IP65
	IP67
	IP68
Ambient temperature (operation)	-25 °C ... 90 °C (Plug / socket)
	-40 °C ... 80 °C (cable, fixed installation)
	-5 °C ... 80 °C (Cable, flexible installation)

# SAC-3P-M12Y/2X1,5-PUR/M12FS - Sensor/actuator cable



1682553

<https://www.phoenixcontact.com/us/products/1682553>

## Drawings

Dimensional drawing



Plug M12 x 1, Y distributor

Dimensional drawing



M12 x 1 socket, straight

# SAC-3P-M12Y/2X1,5-PUR/M12FS - Sensor/actuator cable

1682553

<https://www.phoenixcontact.com/us/products/1682553>

Dimensional drawing



M12 x 1 socket, straight

Schematic diagram

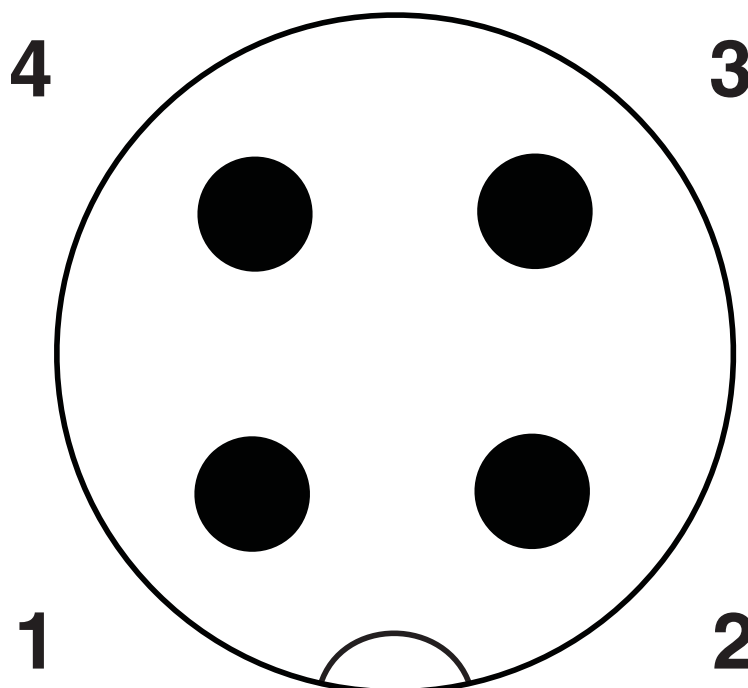

Pin assignment M12 plug, 4-pos., A-coded, view plug side

# SAC-3P-M12Y/2X1,5-PUR/M12FS - Sensor/actuator cable

1682553

<https://www.phoenixcontact.com/us/products/1682553>

Schematic diagram

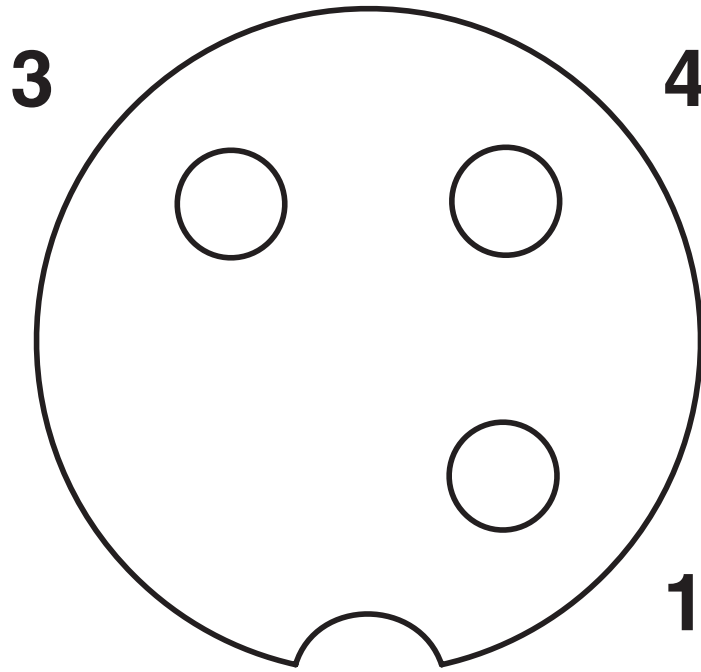

Pin assignment M12 socket, 3-pos., A-coded, view female side

Schematic diagram

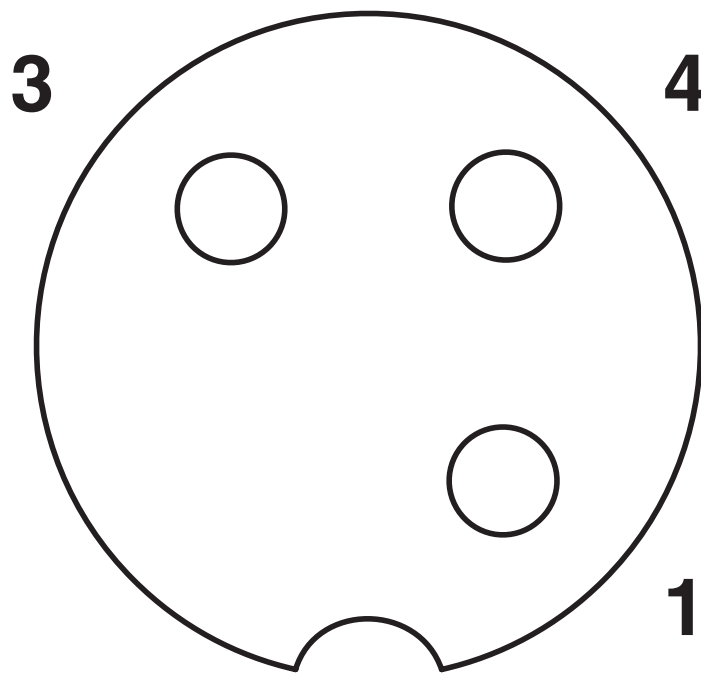

Pin assignment M12 socket, 3-pos., A-coded, view female side

# SAC-3P-M12Y/2X1,5-PUR/M12FS - Sensor/actuator cable



1682553

<https://www.phoenixcontact.com/us/products/1682553>

Circuit diagram

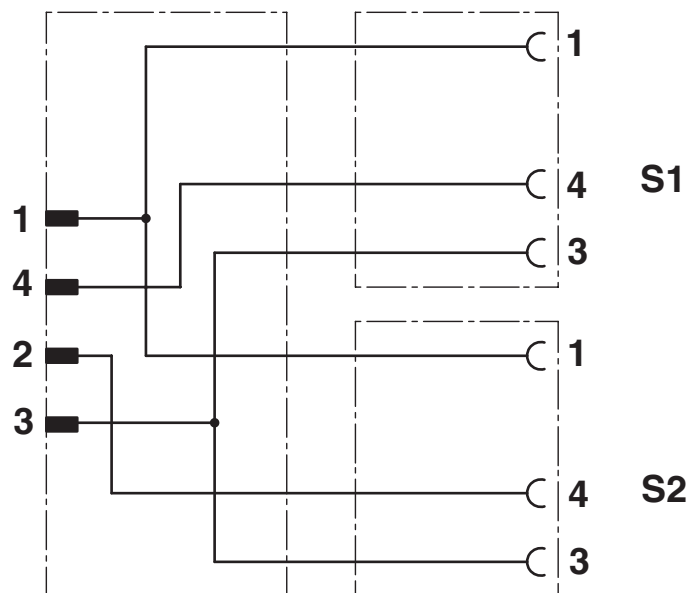

# SAC-3P-M12Y/2X1,5-PUR/M12FS - Sensor/actuator cable





1682553

<https://www.phoenixcontact.com/us/products/1682553>

## Approvals

To download certificates, visit the product detail page: <https://www.phoenixcontact.com/us/products/1682553>

 <b>UL Listed</b> Approval ID: FILE E 221474				
	Nominal voltage $U_N$	Nominal current $I_N$	Cross section AWG	Cross section $\text{mm}^2$
keine				
	300 V	4 A	-	-

 <b>cUL Listed</b> Approval ID: FILE E 221474				
	Nominal voltage $U_N$	Nominal current $I_N$	Cross section AWG	Cross section $\text{mm}^2$
keine				
	300 V	4 A	-	-

 <b>EAC-RoHS</b> Approval ID: RU D-DE.HB35.B.00387	
--	--

# SAC-3P-M12Y/2X1,5-PUR/M12FS - Sensor/actuator cable



1682553

<https://www.phoenixcontact.com/us/products/1682553>

## Classifications

### ECLASS

ECLASS-13.0	27060313
ECLASS-15.0	27060313

### ETIM

ETIM 10.0	EC001855
-----------	----------

### UNSPSC

UNSPSC 21.0	26121600
-------------	----------

# SAC-3P-M12Y/2X1,5-PUR/M12FS - Sensor/actuator cable



1682553

<https://www.phoenixcontact.com/us/products/1682553>

## Environmental product compliance

### EU RoHS

Fulfills EU RoHS substance requirements	Yes, No exemptions
---	--------------------

### China RoHS

Environment friendly use period (EFUP)	EFUP-E
	No hazardous substances above the limits

### EU REACH SVHC

REACH candidate substance (CAS No.)	No substance above 0.1 wt%
-------------------------------------	----------------------------

Phoenix Contact 2026 © - all rights reserved  
<https://www.phoenixcontact.com>

Phoenix Contact USA  
586 Fulling Mill Road  
Middletown, PA 17057, United States  
(+717) 944-1300  
[info@phoenixcon.com](mailto:info@phoenixcon.com)