

SAC-3P-M 8MS/0,6-PUR/M12FR - Sensor/actuator cable



1682359

<https://www.phoenixcontact.com/us/products/1682359>

Please be informed that the data shown in this PDF document is generated from our online catalog. Please find the complete data in the user documentation. Our general terms of use for downloads are valid.



Sensor/actuator cable, 3-position, PUR halogen-free, black-gray RAL 7021, Plug straight M8, coding: A, on Socket angled M12, coding: A, cable length: 0.6 m

Your advantages

- Easy and safe: 100 % electrically tested plug-in components

Commercial data

| | |
|--------------------------------------|---------------|
| Item number | 1682359 |
| Packing unit | 1 pc |
| Minimum order quantity | 1 pc |
| Sales key | BF03 |
| Product key | AF1CBA |
| GTIN | 4017918159016 |
| Weight per piece (including packing) | 25.8 g |
| Weight per piece (excluding packing) | 25.8 g |
| Customs tariff number | 85444290 |
| Country of origin | DE |

SAC-3P-M 8MS/0,6-PUR/M12FR - Sensor/actuator cable



1682359

<https://www.phoenixcontact.com/us/products/1682359>

Technical data

Product properties

| | |
|----------------------|-----------------------|
| Product type | Sensor/actuator cable |
| Application | Standard |
| Number of positions | 3 |
| No. of cable outlets | 1 |
| Shielded | no |
| Coding | A |

Insulation characteristics

| | |
|----------------------|----|
| Overvoltage category | II |
| Degree of pollution | 3 |

Material specifications

| | |
|--|---|
| Flammability rating according to UL 94 | HB |
| Seal material | NBR |
| Material of grip body | TPU, hardly inflammable, self-extinguishing |
| Contact material | CuSn |
| Contact surface material | Ni/Au |
| Contact carrier material | TPU GF |
| Material for screw connection | Zinc die-cast, nickel-plated |

Electrical properties

| | |
|-----------------------|----------------------------|
| Insulation resistance | $\geq 100 \text{ M}\Omega$ |
| Nominal voltage U_N | 48 V AC |
| | 60 V DC |
| Nominal current I_N | 4 A |

Mechanical properties

Mechanical data

| | |
|-----------------------------|------------|
| Insertion/withdrawal cycles | ≥ 100 |
|-----------------------------|------------|

Signaling

| | |
|------------------------|----|
| Status display | no |
| Status display present | no |

Connection data

Conductor connection

| | |
|-------------------|------------------------|
| Tightening torque | 0.4 Nm (M12 connector) |
| | 0.2 Nm (M8 connectors) |

Connector

SAC-3P-M 8MS/0,6-PUR/M12FR - Sensor/actuator cable



1682359

<https://www.phoenixcontact.com/us/products/1682359>

Connection 1

| | |
|---------------------|------------------|
| Type | Plug straight M8 |
| Number of positions | 3 |
| Coding type | A |

Connection 2

| | |
|---------------------|-------------------|
| Type | Socket angled M12 |
| Number of positions | 3 |
| Coding type | A |

Cable/line

| | |
|--------------|-------|
| Cable length | 0.6 m |
|--------------|-------|

PUR halogen-free black [PUR]

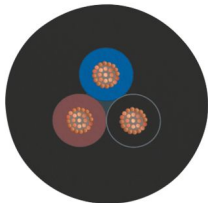
| | |
|---------------------------------|---|
| Dimensional drawing |  |
| Cable weight | 18 kg/km |
| UL AWM Style | 20549 / 10493 (80°C/300 V) |
| Number of positions | 3 |
| Shielded | no |
| Cable type | PUR halogen-free black [PUR] |
| Conductor structure signal line | 32x 0.10 mm |
| AWG signal line | 24 |
| Conductor cross-section | 3x 0.25 mm ² (Signal line) |
| Wire diameter incl. insulation | 1.17 mm ±0.02 mm |
| External cable diameter | 3.60 mm ±0.15 mm |
| Outer sheath, material | PUR |
| External sheath, color | black-gray RAL 7021 |
| Conductor material | Bare Cu litz wires |
| Material wire insulation | PP |
| Single wire, color | brown, blue, black |
| Thickness, insulation | ≥ 0.21 mm (Core insulation) |
| Thickness, outer sheath | approx. 0.50 mm |
| Overall twist | 3 wires, twisted |
| Length of twist, overall twist | 40 mm |
| Max. conductor resistance | ≤ 78 Ω/km (at 20 °C) |
| Insulation resistance | ≥ 100 GΩ*km (at 20 °C) |
| Nominal voltage, cable | ≤ 300 V |

SAC-3P-M 8MS/0,6-PUR/M12FR - Sensor/actuator cable



1682359

<https://www.phoenixcontact.com/us/products/1682359>

| | |
|---|---|
| Test voltage | ≥ 3000 V |
| Smallest bending radius, fixed installation | 18 mm |
| Smallest bending radius, movable installation | 36 mm |
| Dynamic load capacity (bending) | Max. bending cycles: 10000000, Bending radius: 44 mm, Traversing path: 10 m, Traversing rate: 3 m/s, Acceleration: 10 m/s ² |
| Dynamic load capacity (torsion) | Torsion: ±180 °/m, Torsion cycles: ≥5000000, Torsional frequency: 35 cycles/min. |
| Halogen-free | in accordance with DIN VDE 0472 part 815 |
| Flame resistance | in accordance with UL 758/1581 FT2 DIN EN 60332-2-2 (20 s) |
| Resistance to oil | in accordance with DIN EN 60811-2-1 |
| Other resistance | hydrolysis and microbe resistant Highly resistant to acids, alkaline solutions and solvents Resistant to salt water partly UV-resistant (in accordance with DIN EN ISO 4892-2-A) |
| Special properties | Flexible cable conduit capable Silicone-free Free of substances which would hinder coating with paint or varnish |
| Ambient temperature (operation) | -40 °C ... 80 °C (cable, fixed installation) -25 °C ... 80 °C (Cable, flexible installation) |

Environmental and real-life conditions

Ambient conditions

| | |
|---|----------------------------------|
| Degree of protection | IP65 IP67 IP68 |
| Ambient temperature (operation) (male connector/female connector) | -25 °C ... 90 °C (Plug / socket) |

Standards and regulations

| | |
|--------------------------|-----------------|
| Standard designation | M12 connector |
| Standards/specifications | IEC 61076-2-101 |
| Standard designation | M8 connector |
| Standards/specifications | IEC 61076-2-104 |

SAC-3P-M 8MS/0,6-PUR/M12FR - Sensor/actuator cable

1682359

<https://www.phoenixcontact.com/us/products/1682359>

Drawings

Dimensional drawing

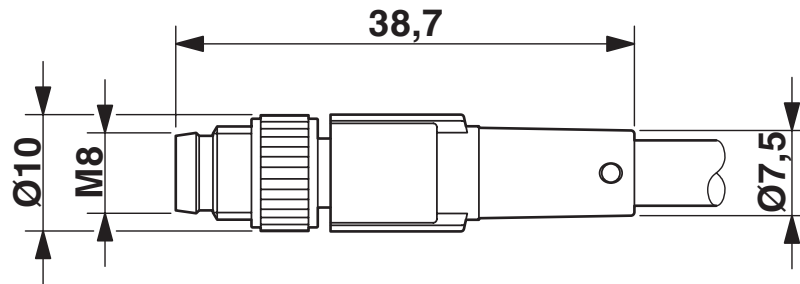

M8 x 1 male plug, straight version

Dimensional drawing

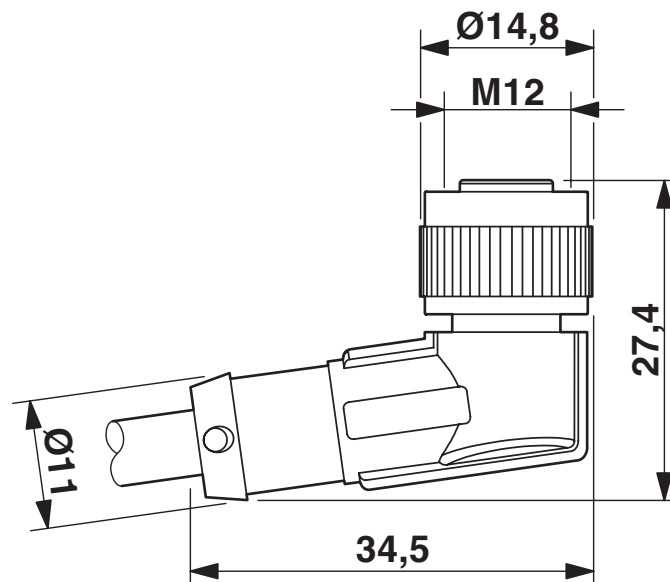

M12 x 1 socket, angled

SAC-3P-M 8MS/0,6-PUR/M12FR - Sensor/actuator cable

1682359

<https://www.phoenixcontact.com/us/products/1682359>

Schematic diagram

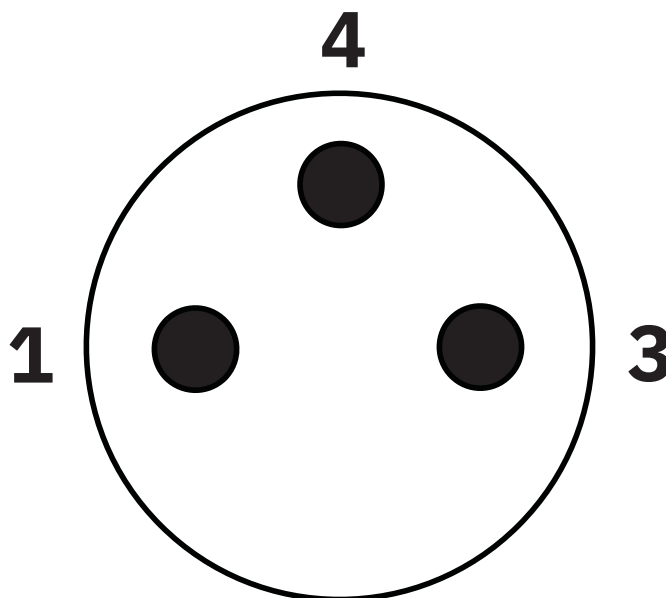

Pin assignment M8 plug, 3-pos., view male side

Schematic diagram

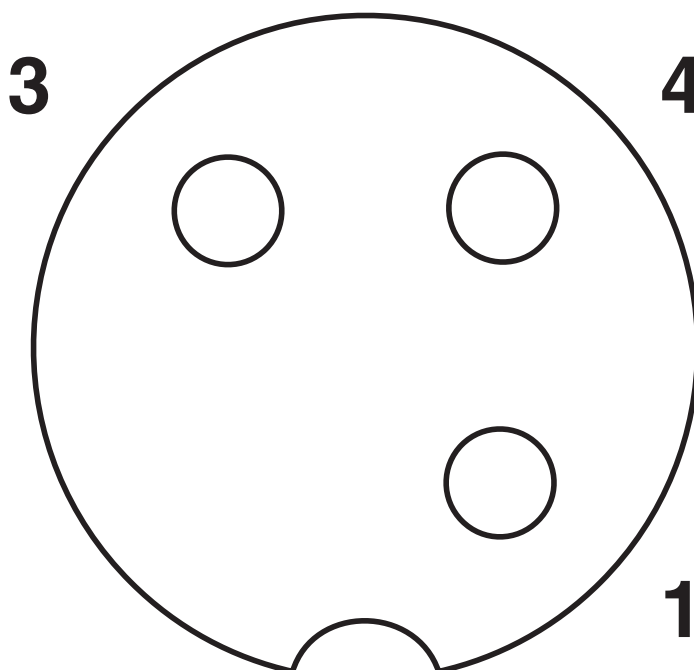

Pin assignment M12 socket, 3-pos., A-coded, view female side

SAC-3P-M 8MS/0,6-PUR/M12FR - Sensor/actuator cable



1682359

<https://www.phoenixcontact.com/us/products/1682359>

Circuit diagram

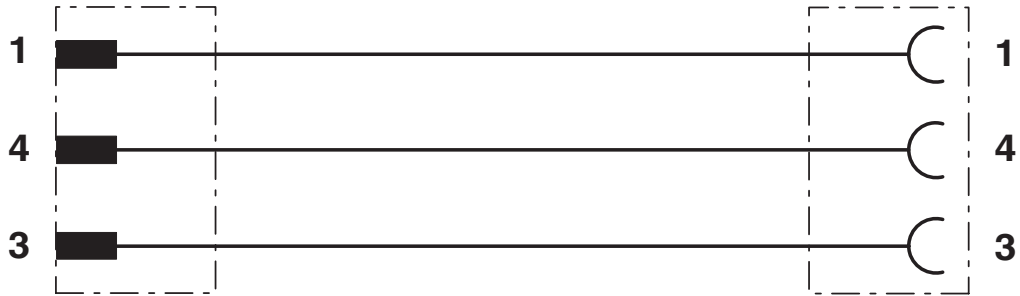

Contact assignment of M8 plugs / M12 sockets

SAC-3P-M 8MS/0,6-PUR/M12FR - Sensor/actuator cable





1682359

<https://www.phoenixcontact.com/us/products/1682359>

Approvals

To download certificates, visit the product detail page: <https://www.phoenixcontact.com/us/products/1682359>

|  UL Listed Approval ID: FILE E 221474 | | | | |
|--|-----------------------|-----------------------|-------------------|-----------------------------|
| | Nominal voltage U_N | Nominal current I_N | Cross section AWG | Cross section mm^2 |
| keine | | | | |
| | 60 V | 4 A | - | - |

|  cUL Listed Approval ID: FILE E 221474 | | | | |
|---|-----------------------|-----------------------|-------------------|-----------------------------|
| | Nominal voltage U_N | Nominal current I_N | Cross section AWG | Cross section mm^2 |
| keine | | | | |
| | 60 V | 4 A | - | - |

|  EAC-RoHS Approval ID: RU D-DE.HB35.B.00387 | |
|--|--|
|--|--|

SAC-3P-M 8MS/0,6-PUR/M12FR - Sensor/actuator cable



1682359

<https://www.phoenixcontact.com/us/products/1682359>

Classifications

ECLASS

| | |
|-------------|----------|
| ECLASS-13.0 | 27060311 |
| ECLASS-15.0 | 27060311 |

ETIM

| | |
|-----------|----------|
| ETIM 10.0 | EC001855 |
|-----------|----------|

UNSPSC

| | |
|-------------|----------|
| UNSPSC 21.0 | 26121600 |
|-------------|----------|

SAC-3P-M 8MS/0,6-PUR/M12FR - Sensor/actuator cable



1682359

<https://www.phoenixcontact.com/us/products/1682359>

Environmental product compliance

EU RoHS

| | |
|---|--------------------|
| Fulfills EU RoHS substance requirements | Yes, No exemptions |
|---|--------------------|

China RoHS

| | |
|--|--|
| Environment friendly use period (EFUP) | EFUP-E |
| | No hazardous substances above the limits |

EU REACH SVHC

| | |
|-------------------------------------|----------------------------|
| REACH candidate substance (CAS No.) | No substance above 0.1 wt% |
|-------------------------------------|----------------------------|

Phoenix Contact 2026 © - all rights reserved
<https://www.phoenixcontact.com>

Phoenix Contact USA
586 Fulling Mill Road
Middletown, PA 17057, United States
(+717) 944-1300
info@phoenixcon.com