

SAC-3P-M12MR/3,0-PUR/M12FR B - Sensor/actuator cable



1668661

<https://www.phoenixcontact.com/us/products/1668661>

Please be informed that the data shown in this PDF document is generated from our online catalog. Please find the complete data in the user documentation. Our general terms of use for downloads are valid.



Sensor/actuator cable, 3-position, PUR halogen-free, black-gray RAL 7021, Plug angled M12, coding: A, on Socket angled M12, coding: A, PIN 2+4 bridged, cable length: 3 m

Your advantages

- Easy and safe: 100 % electrically tested plug-in components
- Efficient integration of bridging functions directly in the connector

Commercial data

Item number	1668661
Packing unit	1 pc
Minimum order quantity	1 pc
Sales key	BF03
Product key	AF1CBA
GTIN	4017918137021
Weight per piece (including packing)	83.1 g
Weight per piece (excluding packing)	83.1 g
Customs tariff number	85444290
Country of origin	PL

SAC-3P-M12MR/3,0-PUR/M12FR B - Sensor/actuator cable



1668661

<https://www.phoenixcontact.com/us/products/1668661>

Technical data

Product properties

Product type	Sensor/actuator cable
Application	Standard
Number of positions	3
No. of cable outlets	1
Shielded	no
Coding	A

Insulation characteristics

Overvoltage category	II
Degree of pollution	3

Material specifications

Flammability rating according to UL 94	HB
Seal material	NBR
Material of grip body	TPU, hardly inflammable, self-extinguishing
Contact material	CuSn
Contact surface material	Ni/Au
Contact carrier material	TPU GF
Material for screw connection	Zinc die-cast, nickel-plated

Electrical properties

Insulation resistance	$\geq 100 \text{ M}\Omega$
Nominal voltage U_N	250 V AC
	250 V DC
Nominal current I_N	4 A

Mechanical properties

Mechanical data

Insertion/withdrawal cycles	≥ 100
-----------------------------	------------

Signaling

Status display	no
Status display present	no

Connection data

Conductor connection

Tightening torque	0.4 Nm (M12 connector)
-------------------	------------------------

Connector

Connection 1

SAC-3P-M12MR/3,0-PUR/M12FR B - Sensor/actuator cable



1668661

<https://www.phoenixcontact.com/us/products/1668661>

Type	Plug angled M12
Coding type	A

Connection 2

Type	Socket angled M12
Coding type	A

Cable/line

Cable length	3 m
--------------	-----

PUR halogen-free black [PUR]

Dimensional drawing	
Cable weight	23 kg/km
UL AWM Style	20549
Number of positions	3
Shielded	no
Cable type	PUR halogen-free black [PUR]
Conductor structure signal line	42x 0.10 mm
AWG signal line	22
Conductor cross-section	3x 0.34 mm ² (Signal line)
Wire diameter incl. insulation	1.27 mm ±0.02 mm (Signal line)
External cable diameter	3.85 mm ±0.15 mm
Outer sheath, material	PUR
External sheath, color	black-gray RAL 7021
Conductor material	Bare Cu litz wires
Material wire insulation	PP
Single wire, color	brown, blue, black
Thickness, insulation	≥ 0.21 mm (Core insulation) approx. 0.50 mm (Outer cable sheath)
Overall twist	3 wires, twisted
Max. conductor resistance	max. 58 Ω/km (at 20 °C)
Insulation resistance	≥ 100 GΩ*km (at 20 °C)
Nominal voltage, cable	≤ 300 V
Test voltage	≥ 3000 V
Smallest bending radius, fixed installation	19 mm
Smallest bending radius, movable installation	38 mm
Dynamic load capacity (bending)	Max. bending cycles: 10000000, Bending radius: 38 mm, Bending radius: 10 x D, Traversing path: 10 m, Traversing rate: 3

SAC-3P-M12MR/3,0-PUR/M12FR B - Sensor/actuator cable



1668661

<https://www.phoenixcontact.com/us/products/1668661>

	m/s, Acceleration: 10 m/s ²
Dynamic load capacity (torsion)	Torsion: ±180 °/m, Torsion cycles: ≥5000000, Torsional frequency: 35 cycles/min.
Halogen-free	in accordance with DIN VDE 0472 part 815
Flame resistance	in accordance with UL 758/1581 FT2 DIN EN 60332-2-2 (20 s)
Resistance to oil	in accordance with DIN EN 60811-2-1
Other resistance	Highly resistant to acids, alkaline solutions and solvents hydrolysis and microbe resistant partly UV-resistant (in accordance with DIN EN ISO 4892-2-A)
Special properties	Flexible cable conduit capable Silicone-free Free of substances which would hinder coating with paint or varnish
Ambient temperature (operation)	-40 °C ... 80 °C (cable, fixed installation) -25 °C ... 80 °C (Cable, flexible installation)

Environmental and real-life conditions

Ambient conditions

Degree of protection	IP65 IP67 IP68
Ambient temperature (operation) (male connector/female connector)	-25 °C ... 90 °C (Plug / socket)
Ambient temperature (operation) (Cable, fixed installation)	-40 °C ... 80 °C (cable, fixed installation)
Ambient temperature (operation) (Cable, flexible installation)	-5 °C ... 80 °C (Cable, flexible installation)

Standards and regulations

Standard designation	M12 connector
Standards/specifications	IEC 61076-2-101

SAC-3P-M12MR/3,0-PUR/M12FR B - Sensor/actuator cable

1668661

<https://www.phoenixcontact.com/us/products/1668661>

Drawings

Dimensional drawing



M12 x 1 male plug, angled

Dimensional drawing



M12 x 1 socket, angled

SAC-3P-M12MR/3,0-PUR/M12FR B - Sensor/actuator cable

1668661

<https://www.phoenixcontact.com/us/products/1668661>

Schematic diagram



Pin assignment M12 plug, 3-pos., A-coded, view male side

Schematic diagram

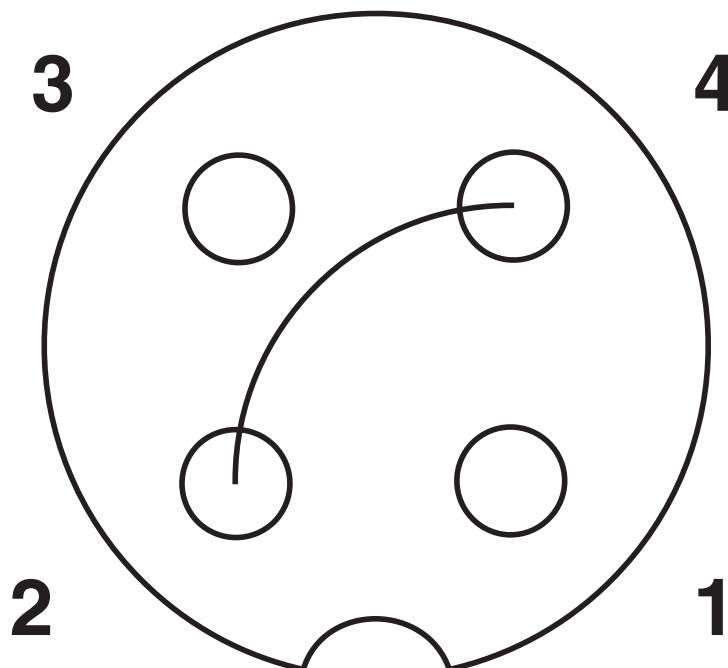

Pin assignment M12 socket, 3-pos., PIN 2+4 bridged, A-coded, view female side

SAC-3P-M12MR/3,0-PUR/M12FR B - Sensor/actuator cable

1668661

<https://www.phoenixcontact.com/us/products/1668661>

Schematic diagram

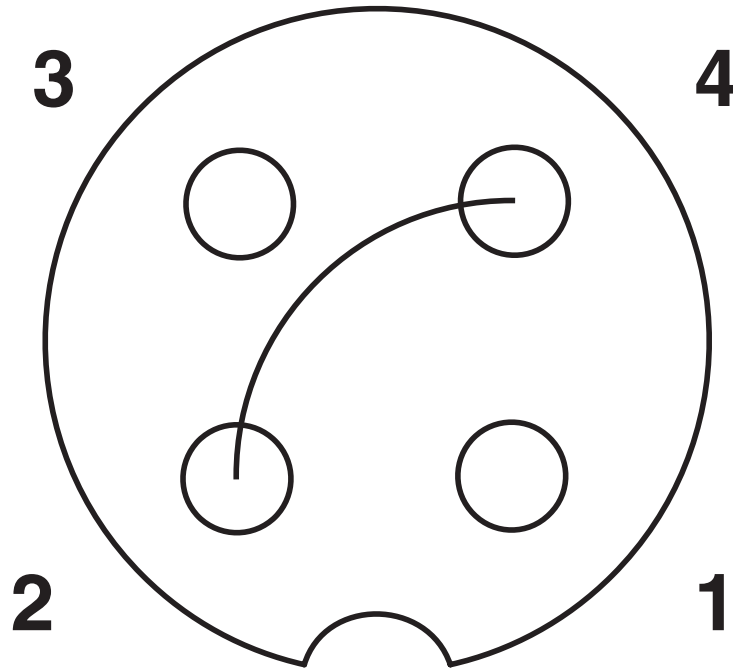

Pin assignment M12 socket, 3-pos., PIN 2+4 bridged, A-coded, view female side

Schematic diagram

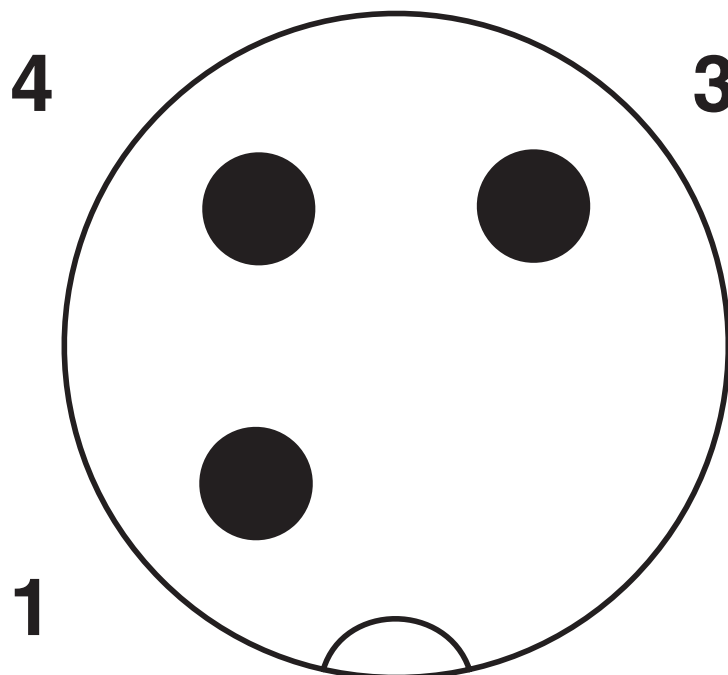

Pin assignment M12, 3-pos.

SAC-3P-M12MR/3,0-PUR/M12FR B - Sensor/actuator cable



1668661

<https://www.phoenixcontact.com/us/products/1668661>

Circuit diagram

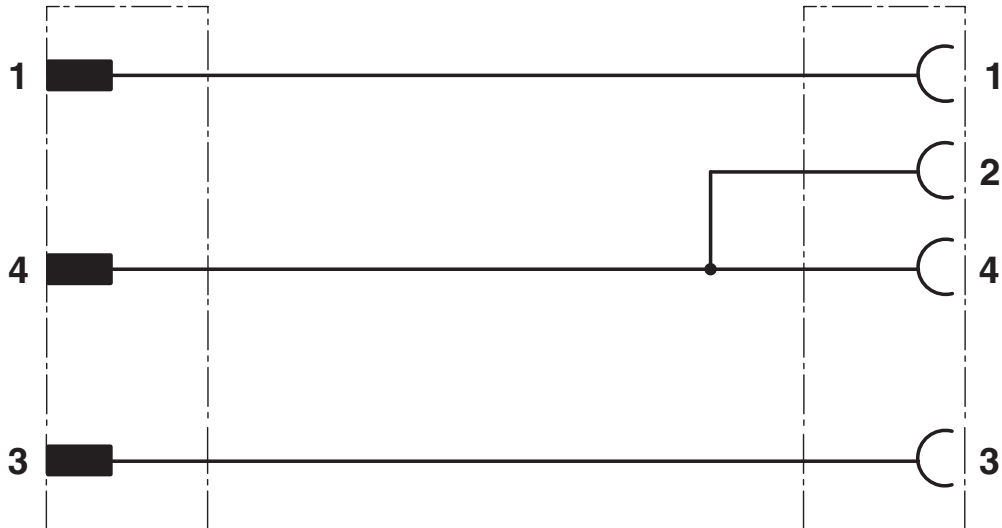

Contact assignment of M12 plugs / sockets bridged

SAC-3P-M12MR/3,0-PUR/M12FR B - Sensor/actuator cable



1668661

<https://www.phoenixcontact.com/us/products/1668661>

Approvals

To download certificates, visit the product detail page: <https://www.phoenixcontact.com/us/products/1668661>

 UL Listed Approval ID: FILE E 221474				
	Nominal voltage U_N	Nominal current I_N	Cross section AWG	Cross section mm^2
keine				
	300 V	4 A	-	-

 cUL Listed Approval ID: FILE E 221474				
	Nominal voltage U_N	Nominal current I_N	Cross section AWG	Cross section mm^2
keine				
	300 V	4 A	-	-

 EAC-RoHS Approval ID: RU D-DE.HB35.B.00387	
--	--

SAC-3P-M12MR/3,0-PUR/M12FR B - Sensor/actuator cable



1668661

<https://www.phoenixcontact.com/us/products/1668661>

Classifications

ECLASS

ECLASS-13.0	27060311
ECLASS-15.0	27060311

ETIM

ETIM 10.0	EC001855
-----------	----------

UNSPSC

UNSPSC 21.0	26121600
-------------	----------

SAC-3P-M12MR/3,0-PUR/M12FR B - Sensor/actuator cable



1668661

<https://www.phoenixcontact.com/us/products/1668661>

Environmental product compliance

EU RoHS

Fulfills EU RoHS substance requirements	Yes, No exemptions
---	--------------------

China RoHS

Environment friendly use period (EFUP)	EFUP-E
	No hazardous substances above the limits

EU REACH SVHC

REACH candidate substance (CAS No.)	No substance above 0.1 wt%
-------------------------------------	----------------------------

EF3.1 Climate Change

CO2e kg	0.999 kg CO2e
---------	---------------

Phoenix Contact 2026 © - all rights reserved
<https://www.phoenixcontact.com>

Phoenix Contact USA
586 Fulling Mill Road
Middletown, PA 17057, United States
(+717) 944-1300
info@phoenixcon.com