

# CK1,6-ED-0,50BU AG - Crimp contact



1663404

<https://www.phoenixcontact.com/us/products/1663404>

Please be informed that the data shown in this PDF document is generated from our online catalog. Please find the complete data in the user documentation. Our general terms of use for downloads are valid.



Crimp contact, series: HC-M-12, Socket, turned, contact diameter: 1.6 mm, rated current: 10 A, connection cross section: 0.5 mm<sup>2</sup> ... 0.5 mm<sup>2</sup>, AWG 20...20, contact material: Cu alloy

## Commercial data

Item number	1663404
Packing unit	100 pc
Minimum order quantity	100 pc
Sales key	BF65
Product key	AF7AIA
GTIN	4017918123215
Weight per piece (including packing)	0.733 g
Weight per piece (excluding packing)	0.692 g
Customs tariff number	85366990
Country of origin	DE

# CK1,6-ED-0,50BU AG - Crimp contact



1663404

<https://www.phoenixcontact.com/us/products/1663404>

## Technical data

### Product properties

Product type	Crimp contact
Series	HC-M-12
	HC-M-EMV
	HC-D
	HC-DD
	VC-D
	HC-M-03/04
	HC-M-17
	HC-K
	HC-Q
	HC-COM
	HC-M-42
	HC-M-08-MBIT
Contact material type	turned

### Connection data

#### Connection technology

Contact connection type	Socket
Connection method	Crimp connection

#### Conductor connection

Stripping length	8 mm
Connection cross section	0.5 mm <sup>2</sup> ... 0.5 mm <sup>2</sup>
Connection cross section AWG	20 ... 20

### Material specifications

Material Contact	Cu alloy
Material Contact surface	Ag

### Dimensions

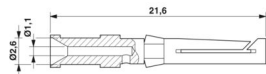
Dimensional drawing	
Diameter (Contact diameter)	1.6 mm

### Electrical properties

Rated current	10 A (Take into account the derating of the contact insert used. The rated current corresponds to the maximum possible connection cross-section.)
---------------	---

### Mechanical properties

# CK1,6-ED-0,50BU AG - Crimp contact



1663404

<https://www.phoenixcontact.com/us/products/1663404>

## Mechanical data

Insertion/withdrawal cycles

≥ 500

## Environmental and real-life conditions

### Ambient conditions

Ambient temperature (operation)

-40 °C ... 125 °C

# CK1,6-ED-0,50BU AG - Crimp contact



1663404

<https://www.phoenixcontact.com/us/products/1663404>

## Drawings

Dimensional drawing

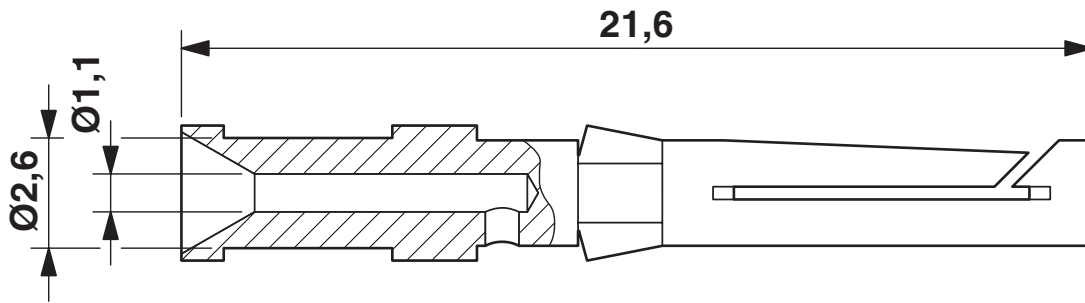

Dimensional drawing

# CK1,6-ED-0,50BU AG - Crimp contact



1663404

<https://www.phoenixcontact.com/us/products/1663404>

## Approvals

To download certificates, visit the product detail page: <https://www.phoenixcontact.com/us/products/1663404>



**EAC**

Approval ID: RU C-DE.AI30.B.01102

# CK1,6-ED-0,50BU AG - Crimp contact



1663404

<https://www.phoenixcontact.com/us/products/1663404>

## Classifications

### ECLASS

ECLASS-13.0	27440204
ECLASS-15.0	27440204

### ETIM

ETIM 10.0	EC000796
-----------	----------

### UNSPSC

UNSPSC 21.0	39121500
-------------	----------

# CK1,6-ED-0,50BU AG - Crimp contact



1663404

<https://www.phoenixcontact.com/us/products/1663404>

## Environmental product compliance

### EU RoHS

Fulfills EU RoHS substance requirements	Yes, No exemptions
---	--------------------

### China RoHS

Environment friendly use period (EFUP)	EFUP-E
	No hazardous substances above the limits

### EU REACH SVHC

REACH candidate substance (CAS No.)	No substance above 0.1 wt%
-------------------------------------	----------------------------

### EF3.1 Climate Change

CO2e kg	0.035 kg CO2e
---------	---------------

Phoenix Contact 2026 © - all rights reserved  
<https://www.phoenixcontact.com>

Phoenix Contact USA  
586 Fulling Mill Road  
Middletown, PA 17057, United States  
(+717) 944-1300  
[info@phoenixcon.com](mailto:info@phoenixcon.com)