

VS-ADP16-VS25GS-BU/BU - Adapter plate



1652473

<https://www.phoenixcontact.com/us/products/1652473>

Please be informed that the data shown in this PDF document is generated from our online catalog. Please find the complete data in the user documentation. Our general terms of use for downloads are valid.

Adapter plate, size B16, reinforced, including panel mounting frame with DSUB 25 protective cover and gender changer contact insert socket/socket



Commercial data

Item number	1652473
Packing unit	1 pc
Note	Made to order (non-returnable)
Sales key	NULL
Product key	ABNMAY
GTIN	4017918969806
Weight per piece (including packing)	72.9 g
Weight per piece (excluding packing)	50 g
Customs tariff number	85366990
Country of origin	DE

VS-ADP16-VS25GS-BU/BU - Adapter plate



1652473

<https://www.phoenixcontact.com/us/products/1652473>

Technical data

Product properties

Product type	Adapter plate
Type	B16

Material specifications

Material	PA
Flammability rating according to UL 94	HB
Seal material	TPE

Environmental and real-life conditions

Ambient conditions

Degree of protection	IP54
Ambient temperature (operation)	-20 °C ... 80 °C

VS-ADP16-VS25GS-BU/BU - Adapter plate

1652473

<https://www.phoenixcontact.com/us/products/1652473>

Drawings

Dimensional drawing

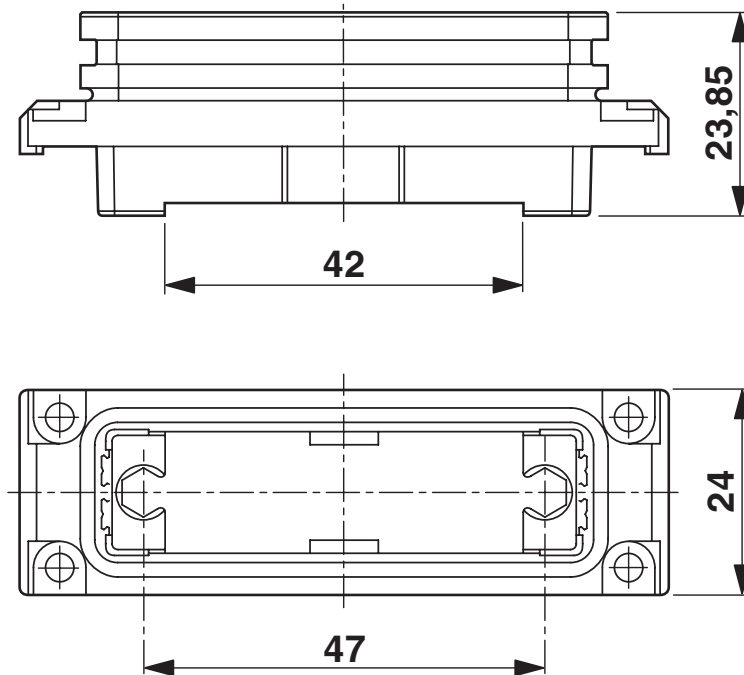

Adapter plate

Dimensional drawing

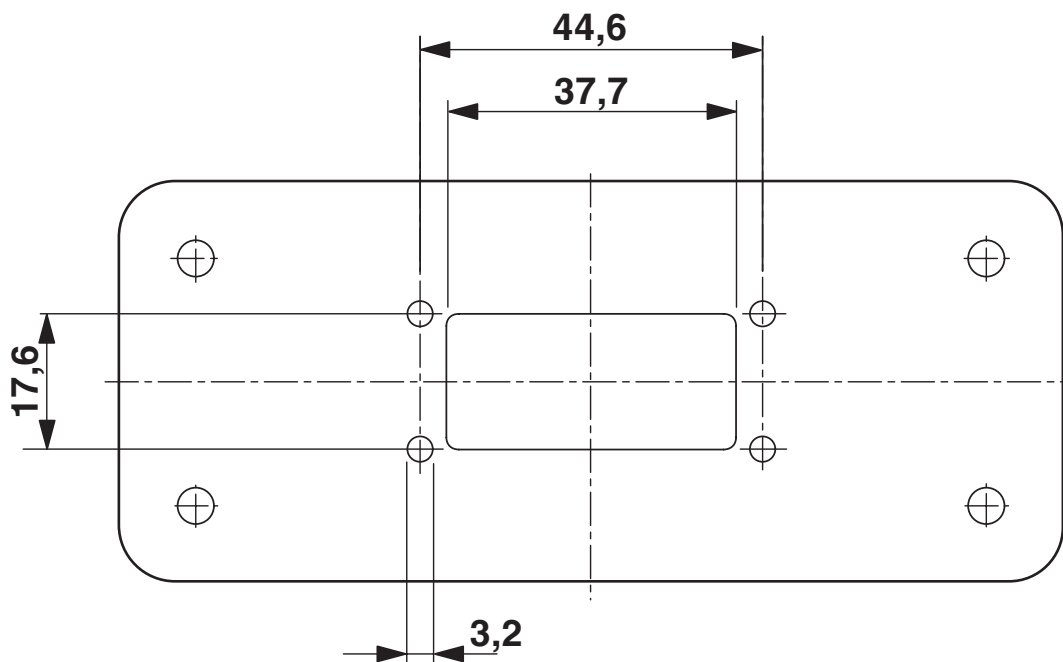

Mounting cutout

VS-ADP16-VS25GS-BU/BU - Adapter plate



1652473

<https://www.phoenixcontact.com/us/products/1652473>

Phoenix Contact 2026 © - all rights reserved

<https://www.phoenixcontact.com>

Phoenix Contact USA
586 Fulling Mill Road
Middletown, PA 17057, United States
(+717) 944-1300
info@phoenixcon.com