

HC-B 10-SFQD-52/O2M20 - Housing



1646492

<https://www.phoenixcontact.com/us/products/1646492>

Please be informed that the data shown in this PDF document is generated from our online catalog. Please find the complete data in the user documentation. Our general terms of use for downloads are valid.



HEAVYCON box mounting base B10, for double locking latch, height 52 mm, with supports 2xM20, with cover

Commercial data

Item number	1646492
Packing unit	1 pc
Note	Made to order (non-returnable)
Sales key	BF55
Product key	AF7AAC
GTIN	4017918985028
Weight per piece (including packing)	250.5 g
Weight per piece (excluding packing)	250.5 g
Customs tariff number	85389099
Country of origin	DE

HC-B 10-SFQD-52/O2M20 - Housing

1646492

<https://www.phoenixcontact.com/us/products/1646492>

Technical data

Product properties

Product type	Housing with locking latch
Housing type	Surface mounting housing
Application	Standard
Type	B10
No. of cable outlets	2
Type of the screw connection	2x M20
Protective cover	yes
Shielded	no
Cable outlet	lateral
Pg screw connection	none

Dimensions

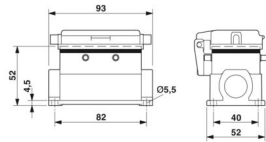
Dimensional drawing	
Width	52 mm
Height	52 mm
Length	93 mm

Material specifications

Seal material	NBR
Housing material	Die-cast aluminum
Housing surface material	Powder-coated, gray
Material, protective cover	PA

Mechanical properties

Mechanical data

Type of the screw connection	2x M20
Locking type	Pin

Environmental and real-life conditions

Ambient conditions

Degree of protection	IP65 (When plugged in)
Ambient temperature (operation)	-40 °C ... 125 °C

HC-B 10-SFQD-52/O2M20 - Housing

1646492

<https://www.phoenixcontact.com/us/products/1646492>



Drawings

Dimensional drawing

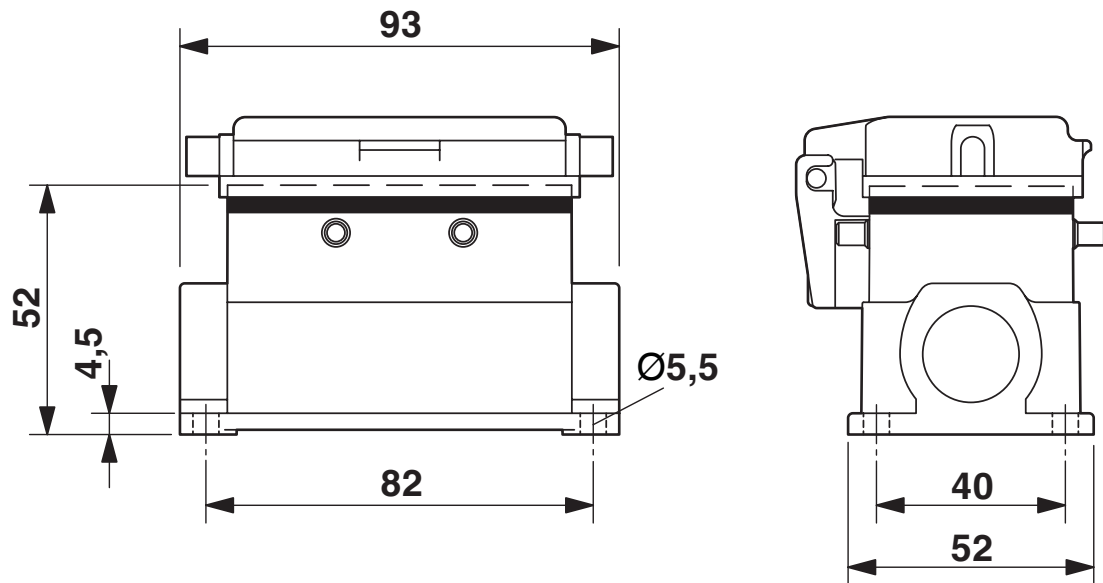

Dimensional drawing

HC-B 10-SFQD-52/O2M20 - Housing



1646492

<https://www.phoenixcontact.com/us/products/1646492>

Classifications

ECLASS

ECLASS-13.0	27440202
ECLASS-15.0	27440202

UNSPSC

UNSPSC 21.0	31261501
-------------	----------

HC-B 10-SFQD-52/O2M20 - Housing



1646492

<https://www.phoenixcontact.com/us/products/1646492>

Environmental product compliance

EU RoHS

Fulfills EU RoHS substance requirements	Yes, No exemptions
---	--------------------

China RoHS

Environment friendly use period (EFUP)	EFUP-E
	No hazardous substances above the limits

EU REACH SVHC

REACH candidate substance (CAS No.)	No substance above 0.1 wt%
-------------------------------------	----------------------------

Phoenix Contact 2026 © - all rights reserved
<https://www.phoenixcontact.com>

Phoenix Contact USA
586 Fulling Mill Road
Middletown, PA 17057, United States
(+717) 944-1300
info@phoenixcon.com