

HC-WRV-M25 - Corrugated tube screw connection



1644902

<https://www.phoenixcontact.com/us/products/1644902>

Please be informed that the data shown in this PDF document is generated from our online catalog. Please find the complete data in the user documentation. Our general terms of use for downloads are valid.



Protective hose screw connection, for protective hose, for leading individual cables and wires into the housing of HEAVYCON industrial connectors, IP65, M25

Commercial data

Item number	1644902
Packing unit	1 pc
Note	Made to order (non-returnable)
Sales key	BF68
Product key	AF7DZX
GTIN	4017918911188
Weight per piece (including packing)	13.21 g
Weight per piece (excluding packing)	12.4 g
Customs tariff number	39174000
Country of origin	DE

HC-WRV-M25 - Corrugated tube screw connection



1644902

<https://www.phoenixcontact.com/us/products/1644902>

Technical data

Product properties

Product type	Protective hose screw connection
Type	Straight

Material specifications

Material	PA
Flammability rating according to UL 94	HB
Material for screw connection	PA

Cable/line

External cable diameter	28.5 mm
-------------------------	---------

Environmental and real-life conditions

Ambient conditions

Degree of protection	IP65
Ambient temperature (operation)	-40 °C ... 110 °C

HC-WRV-M25 - Corrugated tube screw connection

1644902

<https://www.phoenixcontact.com/us/products/1644902>

Drawings

Dimensional drawing

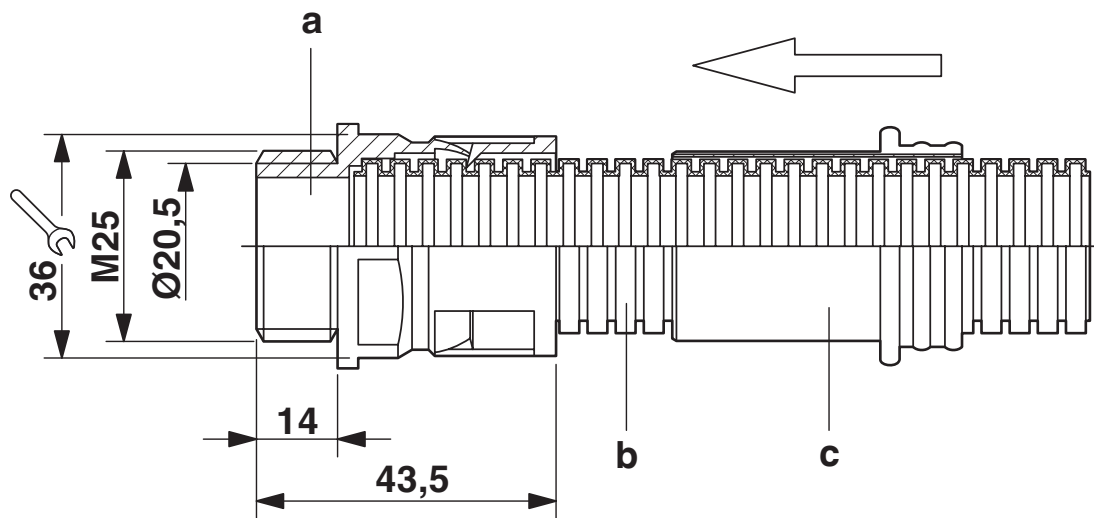

Assembly instructions for Pg 16 corrugated pipe

a = Corrugated screw connection

b = Corrugated pipe

c = N/C contact

Assembly instructions:

Cut the corrugated pipe in the groove to retain a round shape for insertion. The darker outer seal (not shown in the mounting diagram) is pulled inside out over the corrugated tube screw connection. The corrugated pipe is then inserted as far as possible into the corrugated tube screw connection until it audibly clicks into place. To open the screw connection, the yellow corrugated pipe N/C contact is firmly inserted between the locking clip and corrugated pipe, which is then removed.

HC-WRV-M25 - Corrugated tube screw connection



1644902

<https://www.phoenixcontact.com/us/products/1644902>

Environmental product compliance

EU RoHS

Fulfills EU RoHS substance requirements	Yes, No exemptions
---	--------------------

China RoHS

Environment friendly use period (EFUP)	EFUP-E
	No hazardous substances above the limits

EU REACH SVHC

REACH candidate substance (CAS No.)	No substance above 0.1 wt%
-------------------------------------	----------------------------

Phoenix Contact 2026 © - all rights reserved
<https://www.phoenixcontact.com>

Phoenix Contact USA
586 Fulling Mill Road
Middletown, PA 17057, United States
(+717) 944-1300
info@phoenixcon.com