

# M23-5ES198AW500S - Device connector front mounting



1628834

<https://www.phoenixcontact.com/us/products/1628834>

Please be informed that the data shown in this PDF document is generated from our online catalog. Please find the complete data in the user documentation. Our general terms of use for downloads are valid.



M23, Device connector front mounting, application: Power, series: M23 PRO, straight, shielded: yes, for standard and ONECLICK fast locking system, No. of pos.: 5+PE, contact connection type: Socket, Crimp connection, flange dimensions: 26 mm x 26 mm, coding: N, Item is lead-free in accordance with RoHS II without Exemption 6c (Pb < 0.1 %)

The figure shows the product with assembled crimp contacts. Please order crimp contacts separately.

## Your advantages

- Solutions with cross-manufacturer compatibility for standard and fast locking systems
- Modern, consistent design for highly convenient operation
- Crimping connection: vibration- and temperature-resistant assembly
- All housing can be fitted with pin or socket contacts
- Safe use in the field, thanks to high degree of protection

## Commercial data

Item number	1628834
Packing unit	1 pc
Minimum order quantity	1 pc
Sales key	AB30
Product key	ABRBBL
GTIN	4055626763385
Weight per piece (including packing)	52.1 g
Weight per piece (excluding packing)	35.869 g
Customs tariff number	85366990
Country of origin	DE

# M23-5ES198AW500S - Device connector front mounting



1628834

<https://www.phoenixcontact.com/us/products/1628834>

## Technical data

### Notes

Order information:	Order crimp contacts 6 x Ø 2 mm separately
Notes on operation	Please observe the derating curve.

### Safety note

Safety note	<p>WARNING: The connectors may not be plugged in or disconnected under load. Ignoring the warning or improper use may damage persons and/or property.</p>
	<ul style="list-style-type: none"> <li>• WARNING: Commission properly functioning products only. The products must be regularly inspected for damage. Decommission defective products immediately. Replace damaged products. Repairs are not possible.</li> </ul>
	<ul style="list-style-type: none"> <li>• WARNING: Only electrically qualified personnel may install and operate the product. They must observe the following safety notes. The qualified personnel must be familiar with the basics of electrical engineering. They must be able to recognize and prevent danger. The relevant symbol on the packaging indicates that only personnel familiar with electrical engineering are allowed to install and operate the product.</li> </ul>
	<ul style="list-style-type: none"> <li>• The products are suitable for applications in plant, controller, and electrical device engineering.</li> </ul>
	<ul style="list-style-type: none"> <li>• When operating the connectors in outdoor applications, they must be separately protected against environmental influences.</li> </ul>
	<ul style="list-style-type: none"> <li>• Assembled products may not be manipulated or improperly opened.</li> </ul>
	<ul style="list-style-type: none"> <li>• Only use mating connectors that are specified in the technical data of the standards listed (e.g. the ones listed in the product accessories online at <a href="https://www.phoenixcontact.com/products">phoenixcontact.com/products</a>).</li> </ul>
	<ul style="list-style-type: none"> <li>• When using the product in direct connection with third-party manufacturers, the user is responsible.</li> </ul>
	<ul style="list-style-type: none"> <li>• For operating voltages &gt; 50 V AC, conductive connector housings must be grounded</li> </ul>
	<ul style="list-style-type: none"> <li>• Ensure that the protective or functional ground has been properly connected.</li> </ul>
	<ul style="list-style-type: none"> <li>• VDE 0100/1.97 § 411.1.3.2 and DIN EN 60 204/11.98 § 14.1.3 are applicable when combining several circuits in a cable and/or connector</li> </ul>
	<ul style="list-style-type: none"> <li>• Only use tools recommended by Phoenix Contact</li> </ul>
	<ul style="list-style-type: none"> <li>• The installation notes/Design In documents online on the download page at <a href="https://www.phoenixcontact.com/products">phoenixcontact.com/products</a> must be observed for this product.</li> </ul>
	<ul style="list-style-type: none"> <li>• Operate the connector only when it is fully plugged in and interlocked.</li> </ul>
<ul style="list-style-type: none"> <li>• Ensure that when laying the cable, the tensile load on the connectors does not exceed the upper limit specified in the standards.</li> </ul>	
<ul style="list-style-type: none"> <li>• Observe the minimum bending radius of the cable. Lay the cable without twisting it.</li> </ul>	
<ul style="list-style-type: none"> <li>• The connector warms up in normal operation. Depending on the ambient conditions, the surface of the connector can continue to</li> </ul>	

# M23-5ES198AW500S - Device connector front mounting



1628834

<https://www.phoenixcontact.com/us/products/1628834>

warm up. In this case, the user is responsible for posting warnings (e.g. DIN EN ISO 13732-1:2008-12).

## Product properties

Product type	Circular connectors (device side)
Product family	M23 PRO

## Material specifications

Flammability rating according to UL 94	V0
--	----

## Connector

### Insulating body

Note	Order information: Order crimp contacts 6 x Ø 2 mm separately
Coding	N
Material (Insulating body)	PA 6.6
Insertion/withdrawal cycles	100
Connection method	Crimp connection
Contact switching type	Socket
Application	Power
Number of positions	6
Connection profile	5+PE
Installation height	3000 m
Number (Contact group 1)	6
Contact diameter (Contact group 1)	2 mm
Litz wires Min. cross section (Contact group 1)	0.25 mm <sup>2</sup>
Litz wires Max. cross section (Contact group 1)	4 mm <sup>2</sup>
Rated current Contact (Contact group 1)	30 A (for max. connection cross section)
Rated voltage Contact (Contact group 1)	630 V
Rated surge voltage	6 kV
Overvoltage category	III
Degree of pollution	3

### Housing

Type	Flange housing
Thread type	M23
Design	straight
Type of locking	for standard and ONECLICK fast locking system
Mounting type	Front mounting/square flange (4x Ø 3.2 mm)
Flange dimensions	26 mm x 26 mm
Housing material	GD-Zn
Degree of protection (plugged in)	IP66/IP68 (2 m / 24 h) IP69K

## Environmental and real-life conditions

### Ambient conditions

# M23-5ES198AW500S - Device connector front mounting



1628834

<https://www.phoenixcontact.com/us/products/1628834>

Degree of protection	IP68
Ambient temperature (operation)	-40 °C ... 105 °C (see to derating)
Altitude	2000 m
Permanent temperature	125 °C (DIN EN 60512-9-2 / 1000 h)

# M23-5ES198AW500S - Device connector front mounting

1628834

<https://www.phoenixcontact.com/us/products/1628834>

## Drawings

Dimensional drawing



Installation dimensions

# M23-5ES198AW500S - Device connector front mounting

1628834

<https://www.phoenixcontact.com/us/products/1628834>

Schematic diagram

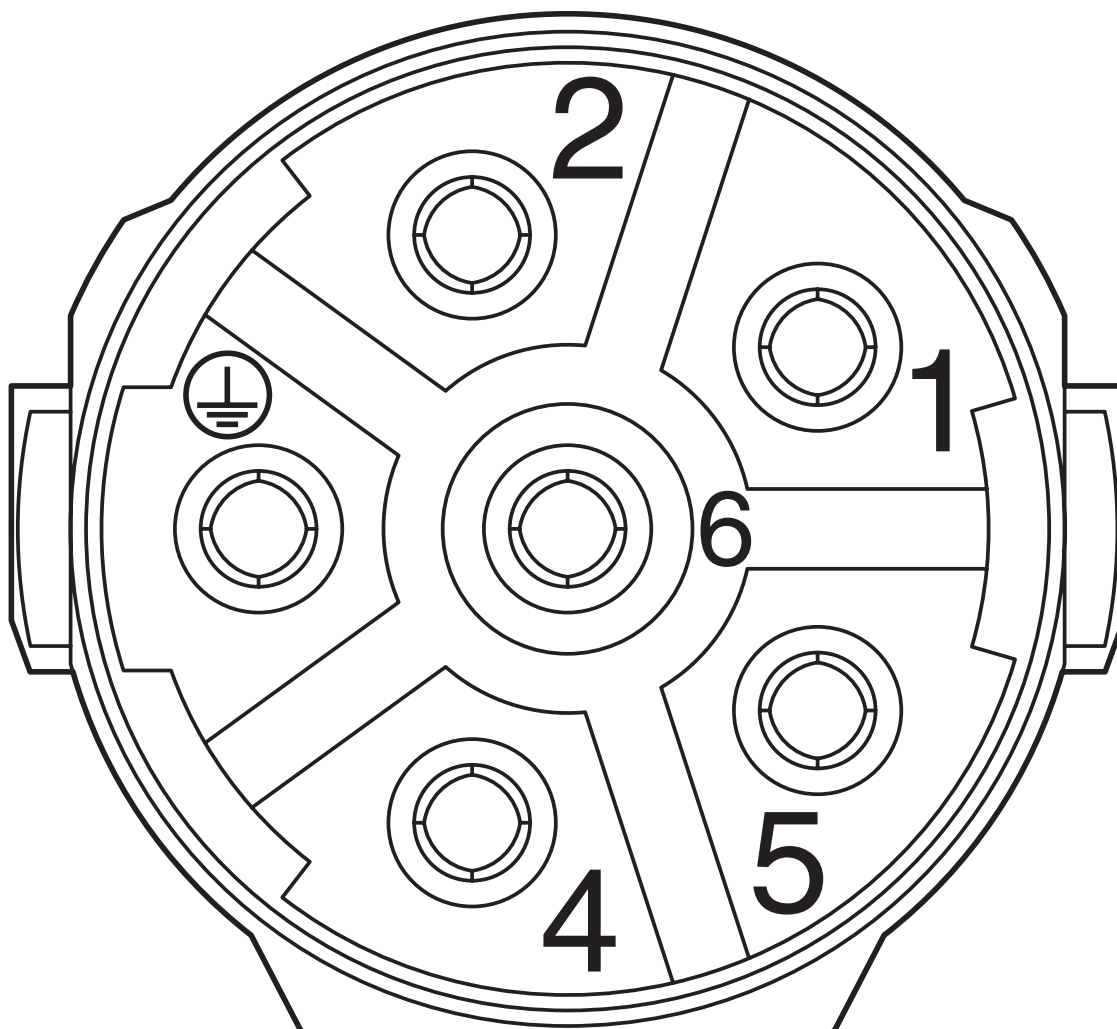

Connector pin assignment

# M23-5ES198AW500S - Device connector front mounting



1628834

<https://www.phoenixcontact.com/us/products/1628834>

Diagram



$I$  = current strength,  $\vartheta$  = ambient temperature, 3 x 30 A (curve 1), 3 x 24 A (curve 2)

# M23-5ES198AW500S - Device connector front mounting



1628834

<https://www.phoenixcontact.com/us/products/1628834>

## Approvals

To download certificates, visit the product detail page: <https://www.phoenixcontact.com/us/products/1628834>



**UL Listed**

Approval ID: E468743-20190627



**cUL Listed**

Approval ID: E468743-20190627

# M23-5ES198AW500S - Device connector front mounting



1628834

<https://www.phoenixcontact.com/us/products/1628834>

## Classifications

### ECLASS

ECLASS-13.0	27440109
ECLASS-15.0	27440109

### ETIM

ETIM 10.0	EC003569
-----------	----------

### UNSPSC

UNSPSC 21.0	39121400
-------------	----------

# M23-5ES198AW500S - Device connector front mounting



1628834

<https://www.phoenixcontact.com/us/products/1628834>

## Environmental product compliance

### EU RoHS

Fulfills EU RoHS substance requirements	Yes, No exemptions
---	--------------------

### China RoHS

Environment friendly use period (EFUP)	EFUP-E
	No hazardous substances above the limits

### EU REACH SVHC

REACH candidate substance (CAS No.)	No substance above 0.1 wt%
-------------------------------------	----------------------------

Phoenix Contact 2026 © - all rights reserved  
<https://www.phoenixcontact.com>

Phoenix Contact USA  
586 Fulling Mill Road  
Middletown, PA 17057, United States  
(+717) 944-1300  
[info@phoenixcon.com](mailto:info@phoenixcon.com)