

PV-C-M/F-PRO/F-1500/20-EU-SPR - Fuse plug



1623411

<https://www.phoenixcontact.com/us/products/1623411>

Please be informed that the data shown in this PDF document is generated from our online catalog. Please find the complete data in the user documentation. Our general terms of use for downloads are valid.



Fuse connector for protecting modules and devices in photovoltaic systems, black, SUNCLIX pin connector pattern, 1500 V/20 A, IP68 (24 h/2 m)

SUNCLIX fuse connector, in the version for 1500 V system voltage

Product description

SUNCLIX fuse connector for 1500 V system voltage, fuse-link nominal current of 20 A, EU version, version with spacer for better heat dissipation when bundling

Commercial data

Item number	1623411
Packing unit	1 pc
Note	Made to order (non-returnable)
Sales key	AB02
Product key	ABLBEA
GTIN	4055626141497
Weight per piece (including packing)	22.22 g
Weight per piece (excluding packing)	22.22 g
Customs tariff number	85354000
Country of origin	DE

PV-C-M/F-PRO/F-1500/20-EU-SPR - Fuse plug



1623411

<https://www.phoenixcontact.com/us/products/1623411>

Technical data

Product properties

Product type	Photovoltaic connectors
Product family	SUNCLIX

Insulation characteristics

Degree of pollution	2
---------------------	---

Electrical properties

Rated voltage (II/2)	1000 V
Rated voltage (III/2)	1500 V
Rated surge voltage (II/2)	12 kV
Rated surge voltage (III/2)	16 kV
Rated surge voltage (III/3)	12 kV
Fuse-link nominal current	20 A DC (Nominal current of the fuse-link)
Fuse adapter nominal current	17 A DC

Dimensions

Dimensional drawing	
Width	24 mm
Height	26.4 mm
Length	220.8 mm

Material specifications

Color of the housing part	black
Flammability rating according to UL 94	V0
Insulating material group	I / CTI 600
Housing material	PPE
Contact material	Cu
Contact surface material	Ag
Contact carrier material	PPE
O-ring material	Silopren LSR 2660

Environmental and real-life conditions

Ambient conditions

Degree of protection (when plugged in)	IP66/IP68 (2 m / 24 h)
Degree of protection	IP66/IP68 (2 m / 24 h)
Ambient temperature (operation) (male connector/female)	-40 °C ... 50 °C

PV-C-M/F-PRO/F-1500/20-EU-SPR - Fuse plug



1623411

<https://www.phoenixcontact.com/us/products/1623411>

connector)

PV-C-M/F-PRO/F-1500/20-EU-SPR - Fuse plug



1623411

<https://www.phoenixcontact.com/us/products/1623411>

Drawings

Dimensional drawing

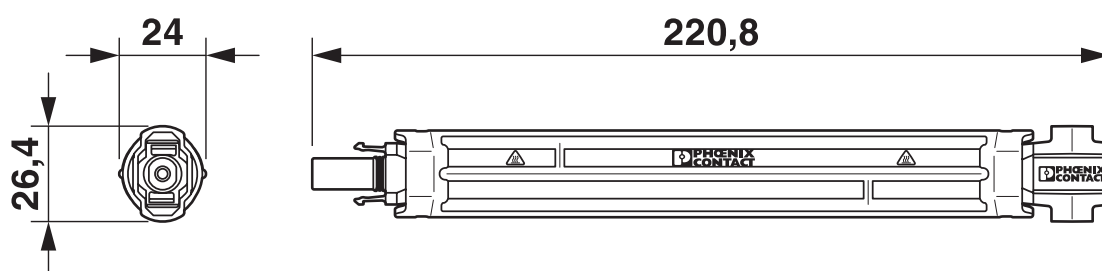

PV-C-M/F-PRO/F-1500/20-EU-SPR - Fuse plug



1623411

<https://www.phoenixcontact.com/us/products/1623411>

Environmental product compliance

EU RoHS

Fulfills EU RoHS substance requirements	Yes, No exemptions
---	--------------------

China RoHS

Environment friendly use period (EFUP)	EFUP-E
	No hazardous substances above the limits

EU REACH SVHC

REACH candidate substance (CAS No.)	No substance above 0.1 wt%
-------------------------------------	----------------------------

Phoenix Contact 2026 © - all rights reserved
<https://www.phoenixcontact.com>

Phoenix Contact USA
586 Fulling Mill Road
Middletown, PA 17057, United States
(+717) 944-1300
info@phoenixcon.com