

RC-06P1N12QBHM - Crimp contact



1610116

<https://www.phoenixcontact.com/us/products/1610116>

Please be informed that the data shown in this PDF document is generated from our online catalog. Please find the complete data in the user documentation. Our general terms of use for downloads are valid.



Crimp contact

Commercial data

Item number	1610116
Packing unit	10 pc
Minimum order quantity	1 pc
Note	Made to order (non-returnable)
Product key	ABRAFJ
GTIN	4046356391184
Weight per piece (including packing)	136.4 g
Weight per piece (excluding packing)	136.4 g
Country of origin	DE

RC-06P1N12QBHM - Crimp contact



1610116

<https://www.phoenixcontact.com/us/products/1610116>

Technical data

Product properties

Product type	Circular connector (cable-side)
--------------	---------------------------------

RC-06P1N12QBHM - Crimp contact



1610116

<https://www.phoenixcontact.com/us/products/1610116>

Drawings

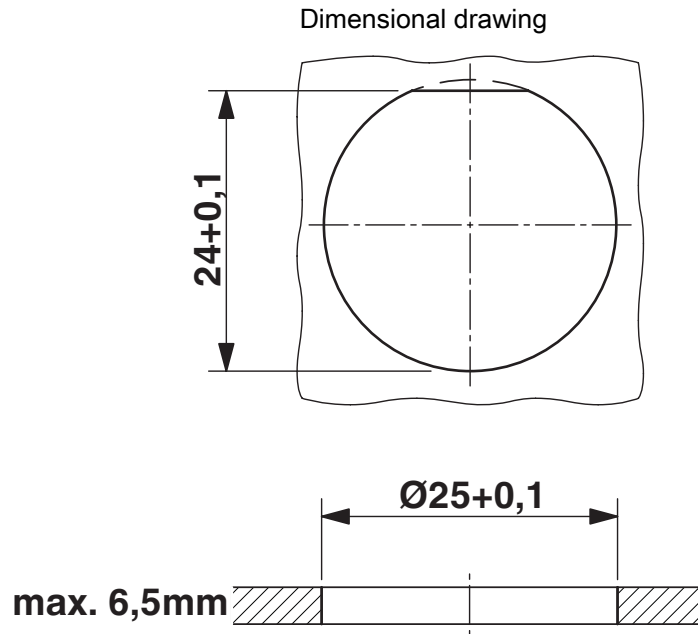

Installation dimensions

Phoenix Contact 2026 © - all rights reserved
<https://www.phoenixcontact.com>

Phoenix Contact USA
586 Fulling Mill Road
Middletown, PA 17057, United States
(+717) 944-1300
info@phoenixcon.com