

# HC-B 6-SML-52/M2M20 - Housing



1586743

<https://www.phoenixcontact.com/us/products/1586743>

Please be informed that the data shown in this PDF document is generated from our online catalog. Please find the complete data in the user documentation. Our general terms of use for downloads are valid.

Box mounting base, with single locking latch, height 52 mm, with screw connection, 2x M20



## Commercial data

Item number	1586743
Packing unit	10 pc
Minimum order quantity	1 pc
Product key	AF7AAC
GTIN	4046356426831
Weight per piece (including packing)	234.23 g
Weight per piece (excluding packing)	226.64 g
Country of origin	DE

# HC-B 6-SML-52/M2M20 - Housing

1586743

<https://www.phoenixcontact.com/us/products/1586743>

## Technical data

### Product properties

Product type	Housing with locking latch
Housing type	Surface mounting housing
Application	Standard
Type	B6
No. of cable outlets	2
Type of the screw connection	2x M20
Shielded	no
Cable outlet	lateral
Pg screw connection	with

### Dimensions

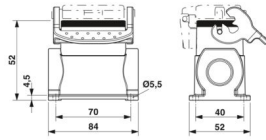
Dimensional drawing	
Width	52 mm
Height	52 mm
Length	84 mm
Wrench size, union nut	20 mm

### Material specifications

Material Screw connection	Brass, nickel-plated
Seal material Cable seal	NBR
Housing material	Die-cast aluminum
Housing surface material	Powder-coated, gray
Locking latch material	Stainless steel, handle: PA

### Mechanical properties

#### Mechanical data

Type of the screw connection	2x M20
Locking type	Latch

### Cable/line

External cable diameter Cable 1	5 mm ... 12 mm (Cable 1)
External cable diameter Cable 2	5 mm ... 12 mm (Cable 2)

### Connection data

External cable diameter	5 mm ... 12 mm (Cable 1)
-------------------------	--------------------------

# HC-B 6-SML-52/M2M20 - Housing

1586743

<https://www.phoenixcontact.com/us/products/1586743>



## Environmental and real-life conditions

### Ambient conditions

Degree of protection	IP65
Ambient temperature (operation)	-40 °C ... 125 °C

# HC-B 6-SML-52/M2M20 - Housing

1586743

<https://www.phoenixcontact.com/us/products/1586743>



## Drawings

Dimensional drawing

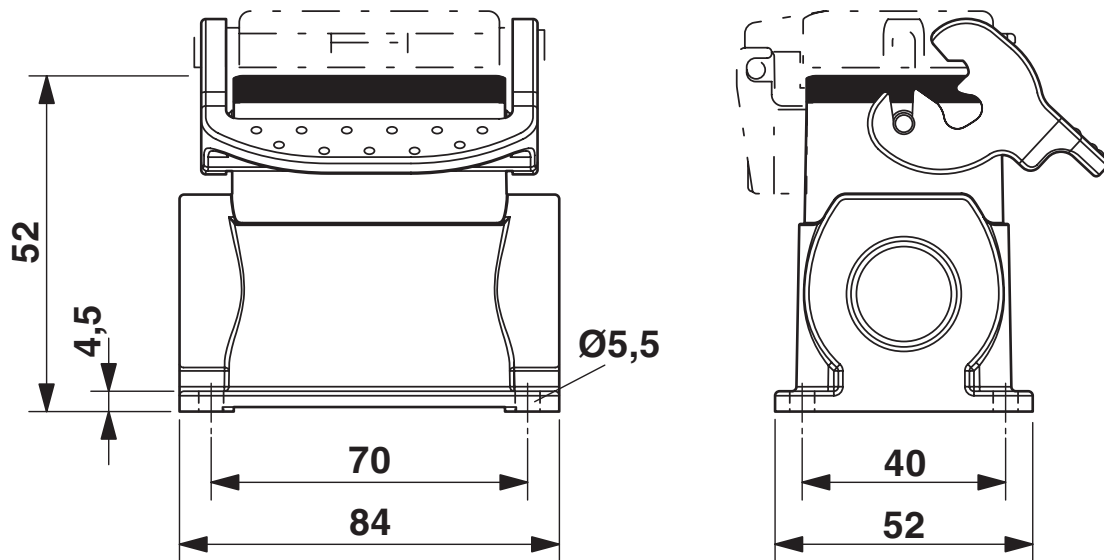

Dimensional drawing

# HC-B 6-SML-52/M2M20 - Housing



1586743

<https://www.phoenixcontact.com/us/products/1586743>

## Classifications

### ECLASS

ECLASS-13.0	27440202
ECLASS-15.0	27440202

### UNSPSC

UNSPSC 21.0	31261501
-------------	----------

# HC-B 6-SML-52/M2M20 - Housing



1586743

<https://www.phoenixcontact.com/us/products/1586743>

## Environmental product compliance

### EU RoHS

Fulfills EU RoHS substance requirements	Yes, No exemptions
---	--------------------

### China RoHS

Environment friendly use period (EFUP)	EFUP-E
	No hazardous substances above the limits

### EU REACH SVHC

REACH candidate substance (CAS No.)	No substance above 0.1 wt%
-------------------------------------	----------------------------

Phoenix Contact 2026 © - all rights reserved  
<https://www.phoenixcontact.com>

Phoenix Contact USA  
586 Fulling Mill Road  
Middletown, PA 17057, United States  
(+717) 944-1300  
[info@phoenixcon.com](mailto:info@phoenixcon.com)